

Lounge Seating price book

Prices effective January 6, 2020

Published July 09, 2020

General Information		2
How to Specify		4
Base Finishes		5-6
Fire Retardancy		7
Upholstery		8-10
Upholstery COM/COL Procedures		11
Upholstery Upcharges		12-17
Upholstery Application Chart		18-25
Wood Finishes		26-27
Brabo™	Vincent Van Duysen	28
Bumper™	Ward Bennett	31
Clamshell™	BassamFellows	32
Crosshatch™	EOOS	34
Geiger Textiles Pillows		35
Rapport™	Isay Weinfield	36
Reframe™	EOOS	42
Rolled Arm™	Ward Bennett	43
Saiba™	Naoto Fukasawa	44
Scissor™	Ward Bennett	46
Sled™	Ward Bennett	47
Tuxedo Component Lounge™	BassamFellows	48
Tuxedo Classic Lounge™	BassamFellows	65
Tuxedo Classic Connecting Lounge™	BassamFellows	68
U-Series™	Ward Bennett	82
Washington Avenue™	Mark Goetz	83
Wood Base™	BassamFellows	84
Index		86

Application of Standard Terms

Only the standard terms of sale stated in this catalog apply to any transaction unless those terms are modified or supplemented by a written document signed by an officer of Geiger International, Inc. ("Geiger"). Any terms contained in Customer's purchase order, including standard printed provisions, that are additional to or contrary to these terms, are not effective.

Use of Furniture and Materials

Geiger assumes that textiles, leathers and products are intended for commercial use and are not being bought for use primarily for personal, family, or household purposes. When installed and used as intended, products remain chattel property, are not considered fixtures, and no interest in them should arise under applicable real estate law.

Furniture Prices

Prices are determined by using the published list prices in effect when Geiger receives Customer's completed purchase order. If Customer's requested ship date is more than three months after Geiger receives Customer's order, it may be repriced using the list prices in effect when products ship. If Customer designates special finishes or options, additional charges may apply. Services such as design, project management, packaging, storage, inside delivery, double handling, installation, or inventory management are not included in Geiger's list prices.

COM / COL Procedures

If an order includes Customer-supplied materials, Customer must ship those materials to Geiger at Customer's own expense. The materials must be tagged with Geiger's confirmation number, item number, Customer's name, and purchase order number. Geiger is not liable for inadequacies in Customer's materials. Geiger will notify Customer of any apparent defects in Customer's materials before manufacturing.

Taxes

Customer is responsible for any local sales taxes or other similar taxes imposed on transactions.

Delays

Geiger is not liable for failure to ship by the acknowledged shipping date or any other date. Geiger is not liable for a delay or failure in shipment or performance if the delay or failure is caused by acts of omission of Customer, its agents, employees, contractors, a governmental authority, or God; delays in transportation; or other similar causes that are not within Geiger's reasonable control. Geiger is excused from further performance of its obligations for the duration of a force majeure cause.

Changes and Cancellation

Geiger's acceptance of an order is final and binding and an order may not be changed or canceled without Geiger's written consent.

Orders placed on any of Geiger's expedited shipment programs and orders of custom-dyed or custom-woven materials may not be changed or canceled. To change or cancel other orders, contact Geiger Customer Care in writing for authorization and applicable charges.

Storage

If Customer cannot accept delivery when products are ready, it is the customer's responsibility to transfer products to storage and products are invoiced at that time. Customer is responsible for actual storage charges and any other expenses relating to the storage of products or materials. Customer bears all risk of loss for products or materials in storage.

Freight Terms

For casegoods and seating orders shipped within the 48 contiguous United States, surface freight charges are included. For textile and leather orders actual freight charges will be invoiced. Orders are shipped via ground carrier unless requested otherwise.

For orders shipped to Alaska or Hawaii, the freight terms stated above apply only to the port of embarkation. Shipments beyond that point are freight collect. Domestic deliveries are shipped FOB Geiger's plant to a destination designated by Customer by a method Geiger selects.

All textile shipments will be made FOB Geiger Textiles, Yaphank, NY 11980. All leather shipments will be made FOB Geiger Textiles, Hildebran, NC 28637.

Packaging and Shipping

Geiger's casegoods products are shipped in component form. Shipments over \$50,000 net are blanket wrapped. Tops and panels are shrink wrapped with cardboard corner protection. Pedestals, storage units, overheads and vertical storage units are wrapped in blankets and shrink wrapped with cardboard corner protection. Blankets are to be returned to Geiger for reuse. If the customer request cartoning on orders over \$50,000 net, there will be a charge of five percent of the net order. Packing materials are recyclable.

Shipments from Geiger Atlanta under \$50,000 net are cartoned. Cartoned shipments are packaged with cardboard channels and shrink wrap.

Geiger seating is cartoned in boxes for all shipments. Blanket wrapping is available upon request.

If Customer requests special shipping or delivery methods, Customer is responsible for any extra costs that result.

Packaging and Shipping (continued)

Customer obtains title to products and materials and assumes the risk of loss for them upon shipment from Geiger's plant. Geiger reserves the right to make partial shipments, of truckload quantities, as products are manufactured.

Shipping Surcharge

A shipping surcharge will be added to all orders under \$100,000 list based on the ship-to address. The surcharge is a percentage of the total list price of the entire order, calculated on the base price only. Upcharges for veneer, edges, textiles, pulls, etc., are not counted in the calculation.

Zone 1	3.0%	(GA, NC, SC)
Zone 2	3.5%	(AL, FL, MS, TN, AR, LA)
Zone 3	4.0%	(IL, IN, KY, MI, OH, WI, IA, KS, MN, MO, ND, NE, SD, DC, MD, VA)
Zone 4	4.5%	(CT, MA, ME, NH, RI, VT, DE, NJ, NY, PA, WV)
Zone 5	5.0%	(OK, TX, AZ, NM, NV, UT, CO)
Zone 6	5.5%	(OR, WA, ID, MT WY, CA, Canada)

International Shipping

Orders for export are shipped Ex Works factory (Incoterms 2000). The charge for export packing is five percent of the net order value. There are no export packing charges on shipments to Canada.

Claims

All blanket wrapped shipments must be unwrapped and inspected at the dock, in the presence of the driver. Claims for "concealed damage" or "subject to inspection" will not be honored on blanket wrapped shipments. All cartoned shipments must be inspected for visual outside damage to the package.

Damages and piece count shortages must be noted on the bill of lading. Freight claims must be filed within 30 days (including cartoned shipments with concealed damage). Contact Customer Care for a warranty/freight claim form and send it by fax, mail or email to:

Geiger International
6095 Fulton Industrial Blvd., SW
Atlanta, GA 30336-2806
Attention: Warranty Department
Fax: 1.404.836.7519

Order Information

Herman Miller dealers must submit all purchase orders to Geiger via Omni. For assistance with this process, please contact Herman Miller Sales Technology Support at 800.833.3330.

All Geiger Gallery and non-Herman Miller dealers may submit their orders via email or fax at 404.836.7519. For assistance with this

Order Information (continued)

process, please contact Geiger Customer Care at 800.456.6452.

Midwest	custcaremw@geigerfurniture.com
New York	custcareny@geigerfurniture.com
Northeast	custcarene@geigerfurniture.com
South	custcaresouth@geigerfurniture.com
West	custcarewest@geigerfurniture.com
Int'l	custcareintl@geigerfurniture.com

Warranty

Geiger International, Inc. ("Geiger"), 6095 Fulton Industrial Blvd., SW, Atlanta, GA 30336-2806, USA, warrants the products sold by it to be free from defects in material and workmanship, regardless of the number of shifts during which the products are used, for the warranty periods specified below.

This warranty covers the sale of Geiger product in all countries. Not all of the product lines appearing on this list are marketed by Geiger in all countries, and appearance on this list does not imply an offer for sale of a product line in a particular place. Product line availability is defined in current price lists applicable to different regions.

Geiger Commercial Office Furniture Products 12 years

All products sold under the Geiger® brand name, except as limited or described below.

Textiles and Leathers 3 years

Includes, but is not limited to Edelman Leather, Geiger, Herman Miller, Maharam, and Place fabrics.

Nonstandard Products 1 to 5 years

Warranty length on nonstandard products not covered by the 12-year warranty is identified on individual product quotes.

All Other Products, Parts, and Services 2 years

Height adjustable bases (electrical parts)

5 years

Height adjustable bases (mechanical parts)
Task light electronic ballasts

3 years

All service parts

6 months

All other products, parts, and any services not listed above, sold or furnished by Geiger, except for consumable products such as light bulbs and other electronic products for which no warranty is given

Warranty (continued)

Other Manufacturers' Products

None

Geiger will pass through to the original purchaser any warranty supplied by other manufacturers to the extent possible, including, but not limited to, open-line laminates.

Provisions that apply to all products and services:

During the applicable warranty period, Geiger, as its sole obligation, will repair or replace (at its option) any product, part, or component covered by this warranty and sold after the effective date of this warranty, which fails under normal use as a result of a defect in material or workmanship; Geiger will repair or replace the aforementioned product, part, or component with a comparable product, part, or component.

This warranty extends only to the original purchasers who acquire new product from Geiger, or its authorized resellers. Any product, part, or component must have been installed, used, and maintained according to Geiger's published instructions in order to be eligible for coverage under this warranty and must not have been subject to misuse or abuse. Any modification to the original product voids the warranty. Geiger does not warrant the performance of the product when used in combination with other than original Geiger product.

The warranty period starts from the date of purchase.

This document inclusively describes all of the warranties given and remedies available with respect to the company's products and services. Geiger disclaims any other warranty whether express or implied, statutory or otherwise, in relation to the products.

Geiger does not warrant:

- natural variations in wood grain or figure or the presence of character marks
- changes in surface finishes due to aging or exposure to light
- marks, scars, or wrinkles occurring naturally in leather
- veins, marks, voids, fissures, or cracks found naturally in stone

In addition, Geiger does not warrant:

- failure resulting from normal wear and tear
- the matching of colors, grains, or textures of natural materials
- the colorfastness or the matching of colors of textiles, including an exact match to cuttings or to swatch cards
- damage, marking, or staining of veneer surfaces due to contact with rubber or similar compounds; damage from sharp objects or imprinting from writing instruments, or prolonged exposure to direct sunlight

Warranty (continued)

Geiger tests Customer's Own Material (COM) and other customer-supplied items for manufacturing quality only and does not provide any warranty with regard to these materials.

Geiger does not warrant products that are exposed to extreme environmental conditions or that have been subject to improper storage.

Geiger's products meet the requirements of national and specific local codes as stated in the price books and other written publications.

TO THE EXTENT ALLOWED BY LAW, ANY IMPLIED WARRANTIES, INCLUDING ANY WARRANTY OF MERCHANTABILITY OR FITNESS FOR A PARTICULAR PURPOSE, ARE DISCLAIMED AND TO THE EXTENT THEY ARE LEGALLY REQUIRED, ARE LIMITED IN DURATION TO THE DURATION OF THIS WRITTEN WARRANTY.

GEIGER SHALL NOT BE LIABLE FOR LOSS OF TIME, INCONVENIENCE, COMMERCIAL LOSS, OR INCIDENTAL OR CONSEQUENTIAL DAMAGES.

Applies in US only: Some states do not allow limitations on how long an implied warranty lasts or do not allow the exclusion or limitation of incidental or consequential damages, so the limitations or exclusions in the two preceding paragraphs may not apply. This warranty gives the purchaser specific legal rights; however, the purchaser may also have other rights that may vary from state to state.

Applies outside US: Except as stated above, Geiger will not be liable for any loss or damage (including costs) however caused, whether direct or consequential, incurred or suffered by the purchaser or any third party in respect of the products but nothing contained herein will or will be considered to exclude or restrict any liability on Geiger's part for death or personal injury resulting from negligence.

Limitations and Disclaimers

Geiger is not liable for loss of time, inconvenience, lost profits, commercial loss, or other special, consequential, or incidental damages for any transaction.

Geiger reserves the right to change its designs, its methods of construction, or its prices, charges, or policies at any time without notice to Customer.

Design Rights

The designs depicted in Geiger's catalogs and price lists are proprietary to Geiger and Geiger reserves the exclusive right to manufacture them. Any reproduction of these designs infringes Geiger's rights and that infringement will be prosecuted.

How to Specify

- For each product ordered, specify a product number string. The string should include the product number and all finish and detail codes in the same sequence as shown at the bottom of the pricebook page.
- Product Number String Example:
SVV4A 943 3A09 998 NOCAL

The product number string above includes all codes for an Brabo lounge chair with the following specifications:

Product Number SVV4A
Seating Wood Finish .. 943 Caramel Cherry
Upholstery 3A/09 Moire/Zin
Base 998 Ebony Ash
Fire Retardancy NOCAL

- Basic Price reflects the price of the seating without upholstery fabric. For total product pricing, determine the price group of the upholstery specified. Add the appropriate upholstery price to the Basic Price. Add additional upcharges for options if required.

Base Finishes

Standard Base Finishes

*For Brabo
(no upcharge)*

BNZBronze
CHR.....Chrome
SACSatin Chrome

Standard Base Metal Finishes

*For Saiba
(no upcharge)*

BK.....Black
CDPolished Aluminum

Standard Base Finishes

*For Scissor
(no upcharge)*

CHR.....Chrome
SACSatin Chrome

Standard Base Metal Finishes

*For Sled
(no upcharge)*

BNZBronze
CHR.....Chrome
SACSatin Chrome

Base Finishes

Standard Base Finishes

For Tuxedo Component Seating
(no upcharge)

926.....Black
AS.....Arctic Silver
PBZ.....Powder Coat Bronze
WHTWhite

Upcharge Base Finishes

For Tuxedo Component Club Chair and
Ottoman without table
(add \$307 upcharge)

BNZBronze
CHR.....Chrome
SACSatin Chrome

For Tuxedo Component Bench, Daybed, Settee,
and Sofa without table
(add \$671 upcharge)

BNZBronze
CHR.....Chrome
SACSatin Chrome

For Tuxedo Component Seating with table
(add \$671 upcharge)

BNZBronze
CHR.....Chrome
SACSatin Chrome

Standard Base Finishes

For Rapport, Tuxedo Classic, and Wood Base Seating
(no upcharge)

Code	Description	Wood Base on Ash	Wood Base on Walnut	Rapport and Tuxedo Classic
662	Toasted Walnut, matte	•	•	W
663	Charred Walnut, matte	•	•	W
664	Bronzed Walnut, matte	•	•	W
665	Smoked Walnut, matte	•	•	W
666	Coffee Walnut, matte	•	•	W
667	Smoked Paldao, matte	•	•	W
669	Warm Paldao, matte	•	•	W
677	Chocolate Ash, matte	•		A
66A	RecoGrain Frosty Ash, matte	•		A
66G	RecoGrain Wenge, matte	•	•	W
68R	RecoGrain Rosewood, matte	•	•	W
69A	RecoGrain Frosty Ash, matte	•		A
69G	RecoGrain Wenge, matte	•	•	W
69R	RecoGrain Rosewood, matte	•	•	W
69T	RecoGrain Teak, matte	•		A
6A1	White Ash, matte	•		A
6ET	Clear On Ash, Ash Solid, matte	•		A
6EU	Oak On Ash, Oak Solid, matte	•		A
6EV	Walnut On Ash, Walnut Solid, matte	•	•	W
6K1	Rift Oak, matte	•		A
6K6	Burnt Oak, matte	•		A
940	Sundance Cherry on Maple, low sheen	•		A
943	Caramel Cherry, low sheen	•		A
946	Cocoa Cherry, low sheen	•		A
956	Cocoa Sapele, low sheen	•		A
962	Toasted Walnut, low sheen	•	•	W
963	Charred Walnut, low sheen	•	•	W
964	Bronzed Walnut, low sheen	•	•	W
965	Smoked Walnut, low sheen	•	•	W
966	Coffee Walnut, low sheen	•	•	W
967	Smoked Paldao, low sheen	•	•	W
969	Warm Paldao, low sheen	•	•	W
972	Sundance Walnut, low sheen			W
977	Chocolate Ash, low sheen	•		A
991	Champagne Ash, low sheen	•		A
998	Ebony Ash, low sheen	•		A
96A	RecoGrain Frosty Ash, low sheen	•		A
96G	RecoGrain Wenge, low sheen	•	•	W
98R	RecoGrain Rosewood, low sheen	•	•	W
99G	RecoGrain Wenge, low sheen	•	•	W
99R	RecoGrain Rosewood, low sheen	•	•	W
99T	RecoGrain Teak, low sheen	•		A
9A1	White Ash, low sheen	•		A
9K1	Rift Oak, low sheen	•		A
9K6	Burnt Oak, low sheen	•		A
ED	Aged Cherry, low sheen	•		A
EK	Medium Red Walnut, low sheen	•	•	W
ET	RecoGrain Natural Ash, matte	•		A
EU	RecoGrain Oak, matte	•		A
EV	RecoGrain Walnut, matte	•	•	W
G2U	Light Brown Walnut, low sheen	•	•	W
G40	Dark Brown Walnut, low sheen	•	•	W
GOU	Walnut, matte	•	•	W
UX	Walnut On Cherry, low sheen	•		A

Cord

Standard Cords

*For Crosshatch Seating
(no upcharge)*

CBKBlack
CBRDark Brown
CGYGray
CCMCream

Fire Retardancy

NOCALFire retardancy not required

Upholstery					
Seating Upholstery	Vendor	Price Group	Seating Upholstery	Vendor	Price Group
Customer's Own Material		COM	Centric	Maharam	I
Customer's Own Leather		COL	Checker	Maharam	K
A Band Apart	Maharam	Q	Checker Split	Maharam	K
Abacus	Maharam	H	Chenille Cord	Maharam	H
Abacus Standard	Maharam	F	Cheswick	Geiger	5
Across	Maharam	G	Circuit	Maharam	G
Agency	Maharam	Q	Claremont	Geiger	5
Akimbo	Maharam	G	Classic Velvet	Geiger	6
All Grain Leather	Edelman	R	Coach Cloth	Maharam	J
Alloy	Maharam	F	Coincide	Maharam	F
Allusion	Geiger	8	Coincide High Performance	Maharam	G
Alpaca Epingle	Maharam	N	Colline	Maharam	G
Alpaca Herringbone	Maharam	L	Colorwheel	Maharam	I
Alpaca Mohair	Geiger	9	Compartment	Maharam	R
Alpaca Velvet	Maharam	N	Corded Stripe	Geiger	9
Alter	Maharam	F	Corduroy Plaid	Geiger	7
Amenia	Geiger	7	Couple	Maharam	H
Anagram	Maharam	H	Crew	Maharam	G
Ankara Cloth	Geiger	10	Crossing	Herman Miller	1
Antico	Geiger	4	Crush	Maharam	F
Apt	Maharam	F	Dapper	Geiger	5
Article	Maharam	E	Dart	Maharam	G
Basketweave	Geiger	8	Deconstructed Rose	Maharam	Q
Bateau	Geiger	4	Derby	Geiger	4
Bavaria	Maharam	S	Design 9297	Maharam	J
Bavaria Stripe	Maharam	O	Dingbats	Maharam	K
Beam	Maharam	H	Disperse	Maharam	G
Bellano	Geiger	7	Ditto	Maharam	H
Bento	Herman Miller	3	Divina MD	Maharam	H
Bespoke Stripe	Maharam	N	Dorset	Geiger	7
Big Foot Leather	Edelman	Z	Double Beam	Geiger	7
Big Stripe	Maharam	P	Double Beam Redux	Geiger	7
Blip	Maharam	H	Double Triangles	Maharam	K
Blumen	Maharam	L	Dwell	Maharam	E
Borders	Maharam	R	Dream Cow Leather	Edelman	R
Bouclé	Geiger	5	EcoHide Classic	Geiger	4
Braid	Geiger	4	EcoHide Vintage	Geiger	5
Brindle	Maharam	F	Envie	Geiger	5
Bristol Leather	Geiger	10	Epingle	Geiger	7
Brushed Camel	Maharam	Q	Epingle Stripe	Maharam	P
Brushed Merino	Maharam	P	Essential Twill	Geiger	5
Button-Up	Geiger	5	Even	Geiger	2
Cambrai	Geiger	3	Exaggerated Plaid	Maharam	L
Canon	Geiger	2	Exchange	Maharam	F
Canvas	Maharam	G	Facets	Maharam	K
Capri	Geiger	7	Floret	Maharam	G

Upholstery					
Seating Upholstery	Vendor	Price Group	Seating Upholstery	Vendor	Price Group
Fluent Crypton	Maharam	G	Milaner	Geiger	7
Focus	Maharam	E	Milestone	Maharam	C
Foot Hills	Geiger	8	Millerstripe	Maharam	L
Free Range Leather	Edelman	V	Mini Plaid	Geiger	3
Fringe	Geiger	4	Minimal	Maharam	F
Garden	Maharam	I	Mister	Maharam	H
Geometri	Maharam	L	Mode	Maharam	D
Granno	Geiger	4	Mohair Supreme	Maharam	L
Graphon	Geiger	7	Moleskin Emboss	Geiger	10
Gridwork	Geiger	6	Murmur	Maharam	C
Hallingdal	Maharam	J	Noble	Herman Miller	5
Harlow	Geiger	5	Novello	Geiger	4
Herman Miller Leather	Herman Miller	9	Octave	Maharam	H
Herringbone	Geiger	5	Offset	Maharam	H
Herringbone Stripe	Maharam	N	Omen	Maharam	G
Hopsak	Herman Miller	5	Optik	Maharam	K
Houndstooth Check	Geiger	5	Orakelblume	Maharam	K
Hours	Maharam	T	Ottoman	Geiger	4
Ingenué	Geiger	5	Ottoman Stripe	Maharam	M
Instill	Maharam	F	Overture	Geiger	6
Iota	Geiger	5	Painted Stripe	Maharam	K
Iron Cloth	Geiger	5	Panno Di Dolcé	Geiger	7
Irregular Grid	Geiger	4	Pantile	Geiger	7
Jacobs Coat	Maharam	L	Pare	Maharam	G
Jolie	Geiger	4	Paver	Maharam	G
Kalista	Geiger	4	Piccolo	Geiger	4
Kindred	Maharam	G	Pick-Stitch Plaid	Geiger	6
Lanalux	Herman Miller	14	Pinpoint	Geiger	3
Layers Garden	Maharam	P	Pitch	Maharam	F
Layers Garden Double	Maharam	U	Pixel Stripe	Geiger	5
Layers Park	Maharam	P	Plait	Maharam	F
Layers Park Double	Maharam	U	Point	Maharam	N
Layers Vineyard Large	Maharam	P	Pristina	Geiger	7
Layers Vineyard Small	Maharam	P	Regatta	Maharam	H
Ledger	Maharam	F	Renata	Geiger	7
Letters	Maharam	L	Repeat Classic Stripe	Maharam	L
Linomix	Herman Miller	11	Repeat Dot Ring	Maharam	L
Lucio	Geiger	5	Resca	Geiger	7
Manner	Maharam	C	Rove	Maharam	F
Massive Paisley	Maharam	Q	Rule	Maharam	H
MCL Leather	Herman Miller	11	Runner	Maharam	G
Mechanism	Maharam	H	Runner Standard	Maharam	F
Meld	Maharam	3	Saille	Geiger	3
Metallic Dream Cow Leather	Edelman	R	Salon	Maharam	H
Metric	Maharam	C	Sateen Weave	Geiger	7
Micro Houndstooth	Geiger	4	Scuba	Maharam	F

<i>Upholstery</i>					
Seating Upholstery	Vendor	Price Group	Seating Upholstery	Vendor	Price Group
Semplice Leather	Geiger	8	Vineyard	Maharam	I
Sequence	Maharam	G	Vionette	Geiger	5
Shuttle Standard	Maharam	F	Voyage	Maharam	I
Skein	Maharam	F	Waterborn	Maharam	J
Soft Tweed	Maharam	J	Wool Epinglé	Geiger	7
Sommar	Geiger	6	Wool Rib	Maharam	J
Staple	Geiger	8	Wool Satin	Geiger	7
Starlet	Geiger	8	Wool Tweed	Geiger	7
Steady	Maharam	F	Wool Velvet	Maharam	N
Steady Crypton	Maharam	G			
Steelcut	Maharam	G			
Steelcut Trio	Maharam	H			
Straightaway	Geiger	5			
Strand	Maharam	G			
Strata	Herman Miller	4			
Striae	Geiger	5			
Stripes	Maharam	L			
Striscia	Geiger	8			
Sudden	Maharam	G			
Superweave	Herman Miller	10			
Tangram	Maharam	J			
Tattersall Reverse	Geiger	6			
Telary	Maharam	J			
Tenera Leather	Geiger	11			
Tenon	Geiger	5			
The Firm	Maharam	Q			
The Story of My Life	Maharam	L			
Threads	Geiger	5			
Tonica	Maharam	G			
Tonus	Maharam	H			
Toostripe	Maharam	L			
Trait	Maharam	F			
Transport	Maharam	J			
Trees	Maharam	K			
Trio	Maharam	I			
True Herringbone	Geiger	7			
Tweeded Stripe	Geiger	3			
Twill Plaid	Geiger	7			
Twist	Herman Miller	2			
Unisol	Maharam	K			
Urban	Maharam	G			
Vaquero	Geiger	5			
Vases	Maharam	I			
Vavare	Geiger	5			
Velvet Plaid	Geiger	7			
Vesture	Geiger	7			

NOTES

Refer to the Geiger Graded-In Textiles & Leathers Guide for colors, codes, and exceptions for all fabrics.

Refer to the Geiger Textiles price list for detailed information on Geiger proprietary fabrics.

See upholstery application chart for approvals and exceptions to seating.

Sotto selvage edge seating available only in leather.

Seating pricing is based on the use of one fabric per individual item. Contact Geiger Customer Care at 800.456.6452 for pricing in multiple fabrics.

Geiger textiles meet ACT standards for commercial upholstery use and the standards set forth in the State of California Home Furnishings Act, Bulletin 117. However, Geiger does not warrant or assume any responsibility for flame-retardant properties or compliance with any flammability standards.

Geiger cannot guarantee that the usage of any individual textile will comply with specific fire codes because compliance is determined by the application of a textile to other components and is subject to regulatory agency review.

Upholstery • COM/COL

Seating COM/COL Procedures

Geiger accepts COM and COL for application on its products. However, Geiger does not warrant the application, suitability, or performance of those materials. Geiger reserves the right to reject any COM or COL that it considers unsuitable. Geiger will notify Customer of any apparent defects in Customer's materials before manufacture.

Use Basic Price for seating upholstered in Customer's Own Material (COM). Add COL price to Basic Price for seating upholstered in Customer's Own Leather (COL).

Express seating orders that include COM or COL are scheduled at Express leadtime when Geiger receives all the materials on the order. Geiger will split ship COM/COL orders only if Customer notifies Geiger in writing that this is required.

Questions regarding COM procedures should be directed to Geiger Customer Care at 800.456.6452 or Herman Miller COM Department at 616.654.3400.

Testing and Approval

All Customer's Own Material and Customer's Own Leather requires testing and approval prior to order submission. Failure to obtain approval will result in delayed processing and scheduling of the order.

Step 1. Herman Miller dealers should request a COM test number through Omni. Customers and dealers without Omni access should contact Geiger Customer Care at 800.456.6452 for a test number.

Step 2. Send one memo-sized sample tagged with the test number to the below address. Saiba lounge seating requires additional fabric for testing in addition to memo-sized sample. See product page for details.

Geiger North Carolina
218 Cline Park Drive
Hildebran, NC 28637
Attn: COM

Step 3. Within four business days of receipt of the samples you will be contacted by Geiger Customer Care or the Herman Miller COM Department with testing results. If approved, you will be given a four-digit COM number for the fabric, and yardage requirements will be confirmed.

The COM number is specific to each fabric and indicates the supplier name, fabric style name, color and applied direction of the fabric. It must be shown on the purchase order and on the COM and COL tagging when shipped to Geiger.

Tagging and Shipment

If an order is to include materials supplied by the Customer, Customer must ship materials to Geiger at Customer's own expense. In order to match the appropriate material with the Customer's order, all COM and COL must be tagged as follows:

COM/COL No. _____
Dealer Name _____
Customer Name _____
Dealer P.O. No. _____
Geiger Order No. _____
Product Item No. _____

For all seating:

Geiger North Carolina
218 Cline Park Drive
Hildebran, NC 28637
Attn: COM

Geiger is not responsible for delays caused by fabric not correctly marked or shipped to the wrong location. Freight charges to ship COM from an incorrect location to Geiger may be charged to the Customer.

COM/COL Requirements

Yardages listed for COM are based on 54" wide fabric, with no repeat. Fabrics which have a repeat that must be matched, or are less than 54" wide, require more yardage and the following chart should be used for determining COM yardage requirements. For fabric with both horizontal and vertical repeats, add the horizontal and vertical repeat inches together. Use the total number of repeat inches to determine the additional fabric needed.

Fabric Width	Plain Fabric	2"- 10" Repeat	11"- 20" Repeat	21"- 25" Repeat	26"- 30" Repeat
54"	0%	10%	15%	20%	25%
51" - 53"	15%	20%	25%	30%	35%
48" - 50"	30%	35%	40%	45%	50%
45" - 47"	45%	50%	55%	60%	65%
36" - 44"	60%	65%	70%	75%	80%

COL requirements are shown in square feet and figured on hides that are 55 square feet or larger. On smaller hides, add 15% to the COL requirements. Hides other than cowhide leather cannot be accepted.

Upholstery Upcharges											
	Yardage Requirement										
Yardage	1/4	1/2	3/4	1	1 1/4	1 1/2	1 3/4	2	2 1/4	2 1/2	2 3/4
Sq. Feet	4 1/2	9	13 1/2	18	22 1/2	27	31 1/2	36	40 1/2	45	49 1/2
CAL133	+17	+33	+49	+65	+82	+98	+114	+130	+147	+163	+179
COL	+18	+36	+54	+72	+90	+108	+126	+144	+162	+180	+198
Group 1	+11	+21	+31	+41	+52	+62	+72	+82	+93	+103	+113
Group 2	+13	+25	+37	+49	+62	+74	+86	+98	+111	+123	+135
Group 3	+16	+31	+46	+61	+77	+92	+107	+122	+138	+153	+168
Group 4	+19	+38	+57	+75	+94	+113	+132	+150	+169	+188	+207
Group 5	+28	+55	+82	+109	+137	+164	+191	+218	+246	+273	+300
Group 6	+36	+72	+108	+143	+179	+215	+251	+286	+322	+358	+394
Group 7	+45	+89	+133	+177	+222	+266	+310	+354	+399	+443	+487
Group 8	+68	+135	+203	+270	+338	+405	+473	+540	+608	+675	+743
Group 9	+84	+168	+252	+335	+419	+503	+587	+670	+754	+838	+922
Group 10	+97	+193	+290	+386	+483	+579	+676	+772	+869	+965	+1,062
Group 11	+108	+216	+324	+432	+540	+648	+756	+864	+972	+1,080	+1,188
Group 12	+124	+247	+370	+493	+617	+740	+863	+986	+1,110	+1,233	+1,356
Group 13	+128	+255	+383	+510	+638	+765	+893	+1,020	+1,148	+1,275	+1,403
Group 14	+142	+283	+425	+566	+708	+849	+991	+1,132	+1,274	+1,415	+1,557
Group A	+9	+17	+26	+34	+43	+51	+60	+68	+77	+85	+94
Group B	+10	+20	+30	+39	+49	+59	+69	+78	+88	+98	+108
Group C	+14	+28	+42	+55	+69	+83	+97	+110	+124	+138	+152
Group D	+19	+37	+55	+73	+92	+110	+128	+146	+165	+183	+201
Group E	+22	+44	+66	+88	+110	+132	+154	+176	+198	+220	+242
Group F	+27	+53	+80	+106	+133	+159	+186	+212	+239	+265	+292
Group G	+36	+72	+108	+144	+180	+216	+252	+288	+324	+360	+396
Group H	+45	+90	+135	+179	+224	+269	+314	+358	+403	+448	+493
Group I	+54	+108	+162	+216	+270	+324	+378	+432	+486	+540	+594
Group J	+64	+127	+190	+253	+317	+380	+443	+506	+570	+633	+696
Group K	+73	+145	+218	+290	+363	+435	+508	+580	+653	+725	+798
Group L	+82	+164	+246	+327	+409	+491	+573	+654	+736	+818	+900
Group M	+91	+182	+273	+364	+455	+546	+637	+728	+819	+910	+1,001
Group N	+101	+201	+301	+401	+502	+602	+702	+802	+903	+1,003	+1,103
Group O	+110	+219	+329	+438	+548	+657	+767	+876	+986	+1,095	+1,205
Group P	+119	+237	+356	+474	+593	+711	+830	+948	+1,067	+1,185	+1,304
Group Q	+137	+274	+411	+547	+684	+821	+958	+1,094	+1,231	+1,368	+1,505
Group R	+191	+382	+573	+763	+954	+1,145	+1,336	+1,526	+1,717	+1,908	+2,099
Group S	+205	+410	+615	+819	+1,024	+1,229	+1,434	+1,638	+1,843	+2,048	+2,253
Group T	+219	+438	+657	+876	+1,095	+1,314	+1,533	+1,752	+1,971	+2,190	+2,409
Group U	+234	+467	+700	+933	+1,167	+1,400	+1,633	+1,866	+2,100	+2,333	+2,566
Group V	+248	+495	+742	+989	+1,237	+1,484	+1,731	+1,978	+2,226	+2,473	+2,720
Group W	+262	+523	+785	+1,046	+1,308	+1,569	+1,831	+2,092	+2,354	+2,615	+2,877
Group X	+276	+552	+828	+1,103	+1,379	+1,655	+1,931	+2,206	+2,482	+2,758	+3,034
Group Y	+290	+580	+870	+1,159	+1,449	+1,739	+2,029	+2,318	+2,608	+2,898	+3,188
Group Z	+304	+608	+912	+1,216	+1,520	+1,824	+2,128	+2,432	+2,736	+3,040	+3,344

Upholstery Upcharges											
	Yardage Requirement										
Yardage	3	3 1/4	3 1/2	3 3/4	4	4 1/4	4 1/2	4 3/4	5	5 1/4	5 1/2
Sq. Feet	54	58 1/2	63	67 1/2	72	76 1/2	81	85 1/2	90	94 1/2	99
CAL133	+195	+212	+228	+244	+260	+277	+293	+309	+325	+342	+358
COL	+216	+234	+252	+270	+288	+306	+324	+342	+360	+378	+396
Group 1	+123	+134	+144	+154	+164	+175	+185	+195	+205	+216	+226
Group 2	+147	+160	+172	+184	+196	+209	+221	+233	+245	+258	+270
Group 3	+183	+199	+214	+229	+244	+260	+275	+290	+305	+321	+336
Group 4	+225	+244	+263	+282	+300	+319	+338	+357	+375	+394	+413
Group 5	+327	+355	+382	+409	+436	+464	+491	+518	+545	+573	+600
Group 6	+429	+465	+501	+537	+572	+608	+644	+680	+715	+751	+787
Group 7	+531	+576	+620	+664	+708	+753	+797	+841	+885	+930	+974
Group 8	+810	+878	+945	+1,013	+1,080	+1,148	+1,215	+1,283	+1,350	+1,418	+1,485
Group 9	+1,005	+1,089	+1,173	+1,257	+1,340	+1,424	+1,508	+1,592	+1,675	+1,759	+1,843
Group 10	+1,158	+1,255	+1,351	+1,448	+1,544	+1,641	+1,737	+1,834	+1,930	+2,027	+2,123
Group 11	+1,296	+1,404	+1,512	+1,620	+1,728	+1,836	+1,944	+2,052	+2,160	+2,268	+2,376
Group 12	+1,479	+1,603	+1,726	+1,849	+1,972	+2,096	+2,219	+2,342	+2,465	+2,589	+2,712
Group 13	+1,530	+1,658	+1,785	+1,913	+2,040	+2,168	+2,295	+2,423	+2,550	+2,678	+2,805
Group 14	+1,698	+1,840	+1,981	+2,123	+2,264	+2,406	+2,547	+2,689	+2,830	+2,972	+3,113
Group A	+102	+111	+119	+128	+136	+145	+153	+162	+170	+179	+187
Group B	+117	+127	+137	+147	+156	+166	+176	+186	+195	+205	+215
Group C	+165	+179	+193	+207	+220	+234	+248	+262	+275	+289	+303
Group D	+219	+238	+256	+274	+292	+311	+329	+347	+365	+384	+402
Group E	+264	+286	+308	+330	+352	+374	+396	+418	+440	+462	+484
Group F	+318	+345	+371	+398	+424	+451	+477	+504	+530	+557	+583
Group G	+432	+468	+504	+540	+576	+612	+648	+684	+720	+756	+792
Group H	+537	+582	+627	+672	+716	+761	+806	+851	+895	+940	+985
Group I	+648	+702	+756	+810	+864	+918	+972	+1,026	+1,080	+1,134	+1,188
Group J	+759	+823	+886	+949	+1,012	+1,076	+1,139	+1,202	+1,265	+1,329	+1,392
Group K	+870	+943	+1,015	+1,088	+1,160	+1,233	+1,305	+1,378	+1,450	+1,523	+1,595
Group L	+981	+1,063	+1,145	+1,227	+1,308	+1,390	+1,472	+1,554	+1,635	+1,717	+1,799
Group M	+1,092	+1,183	+1,274	+1,365	+1,456	+1,547	+1,638	+1,729	+1,820	+1,911	+2,002
Group N	+1,203	+1,304	+1,404	+1,504	+1,604	+1,705	+1,805	+1,905	+2,005	+2,106	+2,206
Group O	+1,314	+1,424	+1,533	+1,643	+1,752	+1,862	+1,971	+2,081	+2,190	+2,300	+2,409
Group P	+1,422	+1,541	+1,659	+1,778	+1,896	+2,015	+2,133	+2,252	+2,370	+2,489	+2,607
Group Q	+1,641	+1,778	+1,915	+2,052	+2,188	+2,325	+2,462	+2,599	+2,735	+2,872	+3,009
Group R	+2,289	+2,480	+2,671	+2,862	+3,052	+3,243	+3,434	+3,625	+3,815	+4,006	+4,197
Group S	+2,457	+2,662	+2,867	+3,072	+3,276	+3,481	+3,686	+3,891	+4,095	+4,300	+4,505
Group T	+2,628	+2,847	+3,066	+3,285	+3,504	+3,723	+3,942	+4,161	+4,380	+4,599	+4,818
Group U	+2,799	+3,033	+3,266	+3,499	+3,732	+3,966	+4,199	+4,432	+4,665	+4,899	+5,132
Group V	+2,967	+3,215	+3,462	+3,709	+3,956	+4,204	+4,451	+4,698	+4,945	+5,193	+5,440
Group W	+3,138	+3,400	+3,661	+3,923	+4,184	+4,446	+4,707	+4,969	+5,230	+5,492	+5,753
Group X	+3,309	+3,585	+3,861	+4,137	+4,412	+4,688	+4,964	+5,240	+5,515	+5,791	+6,067
Group Y	+3,477	+3,767	+4,057	+4,347	+4,636	+4,926	+5,216	+5,506	+5,795	+6,085	+6,375
Group Z	+3,648	+3,952	+4,256	+4,560	+4,864	+5,168	+5,472	+5,776	+6,080	+6,384	+6,688

Upholstery Upcharges											
	Yardage Requirement										
Yardage	5 3/4	6	6 1/4	6 1/2	6 3/4	7	7 1/4	7 1/2	7 3/4	8	8 1/4
Sq. Feet	103 1/2	108	112 1/2	117	121 1/2	126	130 1/2	135	139 1/2	144	148 1/2
CAL133	+374	+390	+407	+423	+439	+455	+472	+488	+504	+520	+537
COL	+414	+432	+450	+468	+486	+504	+522	+540	+558	+576	+594
Group 1	+236	+246	+257	+267	+277	+287	+298	+308	+318	+328	+339
Group 2	+282	+294	+307	+319	+331	+343	+356	+368	+380	+392	+405
Group 3	+351	+366	+382	+397	+412	+427	+443	+458	+473	+488	+504
Group 4	+432	+450	+469	+488	+507	+525	+544	+563	+582	+600	+619
Group 5	+627	+654	+682	+709	+736	+763	+791	+818	+845	+872	+900
Group 6	+823	+858	+894	+930	+966	+1,001	+1,037	+1,073	+1,109	+1,144	+1,180
Group 7	+1,018	+1,062	+1,107	+1,151	+1,195	+1,239	+1,284	+1,328	+1,372	+1,416	+1,461
Group 8	+1,553	+1,620	+1,688	+1,755	+1,823	+1,890	+1,958	+2,025	+2,093	+2,160	+2,228
Group 9	+1,927	+2,010	+2,094	+2,178	+2,262	+2,345	+2,429	+2,513	+2,597	+2,680	+2,764
Group 10	+2,220	+2,316	+2,413	+2,509	+2,606	+2,702	+2,799	+2,895	+2,992	+3,088	+3,185
Group 11	+2,484	+2,592	+2,700	+2,808	+2,916	+3,024	+3,132	+3,240	+3,348	+3,456	+3,564
Group 12	+2,835	+2,958	+3,082	+3,205	+3,328	+3,451	+3,575	+3,698	+3,821	+3,944	+4,068
Group 13	+2,933	+3,060	+3,188	+3,315	+3,443	+3,570	+3,698	+3,825	+3,953	+4,080	+4,208
Group 14	+3,255	+3,396	+3,538	+3,679	+3,821	+3,962	+4,104	+4,245	+4,387	+4,528	+4,670
Group A	+196	+204	+213	+221	+230	+238	+247	+255	+264	+272	+281
Group B	+225	+234	+244	+254	+264	+273	+283	+293	+303	+312	+322
Group C	+317	+330	+344	+358	+372	+385	+399	+413	+427	+440	+454
Group D	+420	+438	+457	+475	+493	+511	+530	+548	+566	+584	+603
Group E	+506	+528	+550	+572	+594	+616	+638	+660	+682	+704	+726
Group F	+610	+636	+663	+689	+716	+742	+769	+795	+822	+848	+875
Group G	+828	+864	+900	+936	+972	+1,008	+1,044	+1,080	+1,116	+1,152	+1,188
Group H	+1,030	+1,074	+1,119	+1,164	+1,209	+1,253	+1,298	+1,343	+1,388	+1,432	+1,477
Group I	+1,242	+1,296	+1,350	+1,404	+1,458	+1,512	+1,566	+1,620	+1,674	+1,728	+1,782
Group J	+1,455	+1,518	+1,582	+1,645	+1,708	+1,771	+1,835	+1,898	+1,961	+2,024	+2,088
Group K	+1,668	+1,740	+1,813	+1,885	+1,958	+2,030	+2,103	+2,175	+2,248	+2,320	+2,393
Group L	+1,881	+1,962	+2,044	+2,126	+2,208	+2,289	+2,371	+2,453	+2,535	+2,616	+2,698
Group M	+2,093	+2,184	+2,275	+2,366	+2,457	+2,548	+2,639	+2,730	+2,821	+2,912	+3,003
Group N	+2,306	+2,406	+2,507	+2,607	+2,707	+2,807	+2,908	+3,008	+3,108	+3,208	+3,309
Group O	+2,519	+2,628	+2,738	+2,847	+2,957	+3,066	+3,176	+3,285	+3,395	+3,504	+3,614
Group P	+2,726	+2,844	+2,963	+3,081	+3,200	+3,318	+3,437	+3,555	+3,674	+3,792	+3,911
Group Q	+3,146	+3,282	+3,419	+3,556	+3,693	+3,829	+3,966	+4,103	+4,240	+4,376	+4,513
Group R	+4,388	+4,578	+4,769	+4,960	+5,151	+5,341	+5,532	+5,723	+5,914	+6,104	+6,295
Group S	+4,710	+4,914	+5,119	+5,324	+5,529	+5,733	+5,938	+6,143	+6,348	+6,552	+6,757
Group T	+5,037	+5,256	+5,475	+5,694	+5,913	+6,132	+6,351	+6,570	+6,789	+7,008	+7,227
Group U	+5,365	+5,598	+5,832	+6,065	+6,298	+6,531	+6,765	+6,998	+7,231	+7,464	+7,698
Group V	+5,687	+5,934	+6,182	+6,429	+6,676	+6,923	+7,171	+7,418	+7,665	+7,912	+8,160
Group W	+6,015	+6,276	+6,538	+6,799	+7,061	+7,322	+7,584	+7,845	+8,107	+8,368	+8,630
Group X	+6,343	+6,618	+6,894	+7,170	+7,446	+7,721	+7,997	+8,273	+8,549	+8,824	+9,100
Group Y	+6,665	+6,954	+7,244	+7,534	+7,824	+8,113	+8,403	+8,693	+8,983	+9,272	+9,562
Group Z	+6,992	+7,296	+7,600	+7,904	+8,208	+8,512	+8,816	+9,120	+9,424	+9,728	+10,032

Upholstery Upcharges											
Yardage	Yardage Requirement										
	8 1/2	8 3/4	9	9 1/4	9 1/2	9 3/4	10	10 1/4	10 1/2	10 3/4	11
Sq. Feet	153	157 1/2	162	166 1/2	171	175 1/2	180	184 1/2	189	193 1/2	198
CAL133	+553	+569	+585	+602	+618	+634	+650	+667	+683	+699	+715
COL	+612	+630	+648	+666	+684	+702	+720	+738	+756	+774	+792
Group 1	+349	+359	+369	+380	+390	+400	+410	+421	+431	+441	+451
Group 2	+417	+429	+441	+454	+466	+478	+490	+503	+515	+527	+539
Group 3	+519	+534	+549	+565	+580	+595	+610	+626	+641	+656	+671
Group 4	+638	+657	+675	+694	+713	+732	+750	+769	+788	+807	+825
Group 5	+927	+954	+981	+1,009	+1,036	+1,063	+1,090	+1,118	+1,145	+1,172	+1,199
Group 6	+1,216	+1,252	+1,287	+1,323	+1,359	+1,395	+1,430	+1,466	+1,502	+1,538	+1,573
Group 7	+1,505	+1,549	+1,593	+1,638	+1,682	+1,726	+1,770	+1,815	+1,859	+1,903	+1,947
Group 8	+2,295	+2,363	+2,430	+2,498	+2,565	+2,633	+2,700	+2,768	+2,835	+2,903	+2,970
Group 9	+2,848	+2,932	+3,015	+3,099	+3,183	+3,267	+3,350	+3,434	+3,518	+3,602	+3,685
Group 10	+3,281	+3,378	+3,474	+3,571	+3,667	+3,764	+3,860	+3,957	+4,053	+4,150	+4,246
Group 11	+3,672	+3,780	+3,888	+3,996	+4,104	+4,212	+4,320	+4,428	+4,536	+4,644	+4,752
Group 12	+4,191	+4,314	+4,437	+4,561	+4,684	+4,807	+4,930	+5,054	+5,177	+5,300	+5,423
Group 13	+4,335	+4,463	+4,590	+4,718	+4,845	+4,973	+5,100	+5,228	+5,355	+5,483	+5,610
Group 14	+4,811	+4,953	+5,094	+5,236	+5,377	+5,519	+5,660	+5,802	+5,943	+6,085	+6,226
Group A	+289	+298	+306	+315	+323	+332	+340	+349	+357	+366	+374
Group B	+332	+342	+351	+361	+371	+381	+390	+400	+410	+420	+429
Group C	+468	+482	+495	+509	+523	+537	+550	+564	+578	+592	+605
Group D	+621	+639	+657	+676	+694	+712	+730	+749	+767	+785	+803
Group E	+748	+770	+792	+814	+836	+858	+880	+902	+924	+946	+968
Group F	+901	+928	+954	+981	+1,007	+1,034	+1,060	+1,087	+1,113	+1,140	+1,166
Group G	+1,224	+1,260	+1,296	+1,332	+1,368	+1,404	+1,440	+1,476	+1,512	+1,548	+1,584
Group H	+1,522	+1,567	+1,611	+1,656	+1,701	+1,746	+1,790	+1,835	+1,880	+1,925	+1,969
Group I	+1,836	+1,890	+1,944	+1,998	+2,052	+2,106	+2,160	+2,214	+2,268	+2,322	+2,376
Group J	+2,151	+2,214	+2,277	+2,341	+2,404	+2,467	+2,530	+2,594	+2,657	+2,720	+2,783
Group K	+2,465	+2,538	+2,610	+2,683	+2,755	+2,828	+2,900	+2,973	+3,045	+3,118	+3,190
Group L	+2,780	+2,862	+2,943	+3,025	+3,107	+3,189	+3,270	+3,352	+3,434	+3,516	+3,597
Group M	+3,094	+3,185	+3,276	+3,367	+3,458	+3,549	+3,640	+3,731	+3,822	+3,913	+4,004
Group N	+3,409	+3,509	+3,609	+3,710	+3,810	+3,910	+4,010	+4,111	+4,211	+4,311	+4,411
Group O	+3,723	+3,833	+3,942	+4,052	+4,161	+4,271	+4,380	+4,490	+4,599	+4,709	+4,818
Group P	+4,029	+4,148	+4,266	+4,385	+4,503	+4,622	+4,740	+4,859	+4,977	+5,096	+5,214
Group Q	+4,650	+4,787	+4,923	+5,060	+5,197	+5,334	+5,470	+5,607	+5,744	+5,881	+6,017
Group R	+6,486	+6,677	+6,867	+7,058	+7,249	+7,440	+7,630	+7,821	+8,012	+8,203	+8,393
Group S	+6,962	+7,167	+7,371	+7,576	+7,781	+7,986	+8,190	+8,395	+8,600	+8,805	+9,009
Group T	+7,446	+7,665	+7,884	+8,103	+8,322	+8,541	+8,760	+8,979	+9,198	+9,417	+9,636
Group U	+7,931	+8,164	+8,397	+8,631	+8,864	+9,097	+9,330	+9,564	+9,797	+10,030	+10,263
Group V	+8,407	+8,654	+8,901	+9,149	+9,396	+9,643	+9,890	+10,138	+10,385	+10,632	+10,879
Group W	+8,891	+9,153	+9,414	+9,676	+9,937	+10,199	+10,460	+10,722	+10,983	+11,245	+11,506
Group X	+9,376	+9,652	+9,927	+10,203	+10,479	+10,755	+11,030	+11,306	+11,582	+11,858	+12,133
Group Y	+9,852	+10,142	+10,431	+10,721	+11,011	+11,301	+11,590	+11,880	+12,170	+12,460	+12,749
Group Z	+10,336	+10,640	+10,944	+11,248	+11,552	+11,856	+12,160	+12,464	+12,768	+13,072	+13,376

Upholstery Upcharges											
	Yardage Requirement										
Yardage	11 1/4	11 1/2	11 3/4	12	12 1/4	12 1/2	12 3/4	13	13 1/4	13 1/2	13 3/4
Sq. Feet	202 1/2	207	211 1/2	216	220 1/2	225	229 1/2	234	238 1/2	243	247 1/2
CAL133	+732	+748	+764	+780	+797	+813	+829	+845	+862	+878	+894
COL	+810	+828	+846	+864	+882	+900	+918	+936	+954	+972	+990
Group 1	+462	+472	+482	+492	+503	+513	+523	+533	+544	+554	+564
Group 2	+552	+564	+576	+588	+601	+613	+625	+637	+650	+662	+674
Group 3	+687	+702	+717	+732	+748	+763	+778	+793	+809	+824	+839
Group 4	+844	+863	+882	+900	+919	+938	+957	+975	+994	+1,013	+1,032
Group 5	+1,227	+1,254	+1,281	+1,308	+1,336	+1,363	+1,390	+1,417	+1,445	+1,472	+1,499
Group 6	+1,609	+1,645	+1,681	+1,716	+1,752	+1,788	+1,824	+1,859	+1,895	+1,931	+1,967
Group 7	+1,992	+2,036	+2,080	+2,124	+2,169	+2,213	+2,257	+2,301	+2,346	+2,390	+2,434
Group 8	+3,038	+3,105	+3,173	+3,240	+3,308	+3,375	+3,443	+3,510	+3,578	+3,645	+3,713
Group 9	+3,769	+3,853	+3,937	+4,020	+4,104	+4,188	+4,272	+4,355	+4,439	+4,523	+4,607
Group 10	+4,343	+4,439	+4,536	+4,632	+4,729	+4,825	+4,922	+5,018	+5,115	+5,211	+5,308
Group 11	+4,860	+4,968	+5,076	+5,184	+5,292	+5,400	+5,508	+5,616	+5,724	+5,832	+5,940
Group 12	+5,547	+5,670	+5,793	+5,916	+6,040	+6,163	+6,286	+6,409	+6,533	+6,656	+6,779
Group 13	+5,738	+5,865	+5,993	+6,120	+6,248	+6,375	+6,503	+6,630	+6,758	+6,885	+7,013
Group 14	+6,368	+6,509	+6,651	+6,792	+6,934	+7,075	+7,217	+7,358	+7,500	+7,641	+7,783
Group A	+383	+391	+400	+408	+417	+425	+434	+442	+451	+459	+468
Group B	+439	+449	+459	+468	+478	+488	+498	+507	+517	+527	+537
Group C	+619	+633	+647	+660	+674	+688	+702	+715	+729	+743	+757
Group D	+822	+840	+858	+876	+895	+913	+931	+949	+968	+986	+1,004
Group E	+990	+1,012	+1,034	+1,056	+1,078	+1,100	+1,122	+1,144	+1,166	+1,188	+1,210
Group F	+1,193	+1,219	+1,246	+1,272	+1,299	+1,325	+1,352	+1,378	+1,405	+1,431	+1,458
Group G	+1,620	+1,656	+1,692	+1,728	+1,764	+1,800	+1,836	+1,872	+1,908	+1,944	+1,980
Group H	+2,014	+2,059	+2,104	+2,148	+2,193	+2,238	+2,283	+2,327	+2,372	+2,417	+2,462
Group I	+2,430	+2,484	+2,538	+2,592	+2,646	+2,700	+2,754	+2,808	+2,862	+2,916	+2,970
Group J	+2,847	+2,910	+2,973	+3,036	+3,100	+3,163	+3,226	+3,289	+3,353	+3,416	+3,479
Group K	+3,263	+3,335	+3,408	+3,480	+3,553	+3,625	+3,698	+3,770	+3,843	+3,915	+3,988
Group L	+3,679	+3,761	+3,843	+3,924	+4,006	+4,088	+4,170	+4,251	+4,333	+4,415	+4,497
Group M	+4,095	+4,186	+4,277	+4,368	+4,459	+4,550	+4,641	+4,732	+4,823	+4,914	+5,005
Group N	+4,512	+4,612	+4,712	+4,812	+4,913	+5,013	+5,113	+5,213	+5,314	+5,414	+5,514
Group O	+4,928	+5,037	+5,147	+5,256	+5,366	+5,475	+5,585	+5,694	+5,804	+5,913	+6,023
Group P	+5,333	+5,451	+5,570	+5,688	+5,807	+5,925	+6,044	+6,162	+6,281	+6,399	+6,518
Group Q	+6,154	+6,291	+6,428	+6,564	+6,701	+6,838	+6,975	+7,111	+7,248	+7,385	+7,522
Group R	+8,584	+8,775	+8,966	+9,156	+9,347	+9,538	+9,729	+9,919	+10,110	+10,301	+10,492
Group S	+9,214	+9,419	+9,624	+9,828	+10,033	+10,238	+10,443	+10,647	+10,852	+11,057	+11,262
Group T	+9,855	+10,074	+10,293	+10,512	+10,731	+10,950	+11,169	+11,388	+11,607	+11,826	+12,045
Group U	+10,497	+10,730	+10,963	+11,196	+11,430	+11,663	+11,896	+12,129	+12,363	+12,596	+12,829
Group V	+11,127	+11,374	+11,621	+11,868	+12,116	+12,363	+12,610	+12,857	+13,105	+13,352	+13,599
Group W	+11,768	+12,029	+12,291	+12,552	+12,814	+13,075	+13,337	+13,598	+13,860	+14,121	+14,383
Group X	+12,409	+12,685	+12,961	+13,236	+13,512	+13,788	+14,064	+14,339	+14,615	+14,891	+15,167
Group Y	+13,039	+13,329	+13,619	+13,908	+14,198	+14,488	+14,778	+15,067	+15,357	+15,647	+15,937
Group Z	+13,680	+13,984	+14,288	+14,592	+14,896	+15,200	+15,504	+15,808	+16,112	+16,416	+16,720

Upholstery Upcharges											
	Yardage Requirement										
Yardage	14	14 1/4	14 1/2	14 3/4	15	15 1/4	15 1/2	15 3/4	16	16 1/4	16 1/2
Sq. Feet	252	256 1/2	261	265 1/2	270	274 1/2	279	283 1/2	288	292 1/2	297
CAL133	+910	+927	+943	+959	+975	+992	+1,008	+1,024	+1,040	+1,057	+1,073
COL	+1,008	+1,026	+1,044	+1,062	+1,080	+1,098	+1,116	+1,134	+1,152	+1,170	+1,188
Group 1	+574	+585	+595	+605	+615	+626	+636	+646	+656	+667	+677
Group 2	+686	+699	+711	+723	+735	+748	+760	+772	+784	+797	+809
Group 3	+854	+870	+885	+900	+915	+931	+946	+961	+976	+992	+1,007
Group 4	+1,050	+1,069	+1,088	+1,107	+1,125	+1,144	+1,163	+1,182	+1,200	+1,219	+1,238
Group 5	+1,526	+1,554	+1,581	+1,608	+1,635	+1,663	+1,690	+1,717	+1,744	+1,772	+1,799
Group 6	+2,002	+2,038	+2,074	+2,110	+2,145	+2,181	+2,217	+2,253	+2,288	+2,324	+2,360
Group 7	+2,478	+2,523	+2,567	+2,611	+2,655	+2,700	+2,744	+2,788	+2,832	+2,877	+2,921
Group 8	+3,780	+3,848	+3,915	+3,983	+4,050	+4,118	+4,185	+4,253	+4,320	+4,388	+4,455
Group 9	+4,690	+4,774	+4,858	+4,942	+5,025	+5,109	+5,193	+5,277	+5,360	+5,444	+5,528
Group 10	+5,404	+5,501	+5,597	+5,694	+5,790	+5,887	+5,983	+6,080	+6,176	+6,273	+6,369
Group 11	+6,048	+6,156	+6,264	+6,372	+6,480	+6,588	+6,696	+6,804	+6,912	+7,020	+7,128
Group 12	+6,902	+7,026	+7,149	+7,272	+7,395	+7,519	+7,642	+7,765	+7,888	+8,012	+8,135
Group 13	+7,140	+7,268	+7,395	+7,523	+7,650	+7,778	+7,905	+8,033	+8,160	+8,288	+8,415
Group 14	+7,924	+8,066	+8,207	+8,349	+8,490	+8,632	+8,773	+8,915	+9,056	+9,198	+9,339
Group A	+476	+485	+493	+502	+510	+519	+527	+536	+544	+553	+561
Group B	+546	+556	+566	+576	+585	+595	+605	+615	+624	+634	+644
Group C	+770	+784	+798	+812	+825	+839	+853	+867	+880	+894	+908
Group D	+1,022	+1,041	+1,059	+1,077	+1,095	+1,114	+1,132	+1,150	+1,168	+1,187	+1,205
Group E	+1,232	+1,254	+1,276	+1,298	+1,320	+1,342	+1,364	+1,386	+1,408	+1,430	+1,452
Group F	+1,484	+1,511	+1,537	+1,564	+1,590	+1,617	+1,643	+1,670	+1,696	+1,723	+1,749
Group G	+2,016	+2,052	+2,088	+2,124	+2,160	+2,196	+2,232	+2,268	+2,304	+2,340	+2,376
Group H	+2,506	+2,551	+2,596	+2,641	+2,685	+2,730	+2,775	+2,820	+2,864	+2,909	+2,954
Group I	+3,024	+3,078	+3,132	+3,186	+3,240	+3,294	+3,348	+3,402	+3,456	+3,510	+3,564
Group J	+3,542	+3,606	+3,669	+3,732	+3,795	+3,859	+3,922	+3,985	+4,048	+4,112	+4,175
Group K	+4,060	+4,133	+4,205	+4,278	+4,350	+4,423	+4,495	+4,568	+4,640	+4,713	+4,785
Group L	+4,578	+4,660	+4,742	+4,824	+4,905	+4,987	+5,069	+5,151	+5,232	+5,314	+5,396
Group M	+5,096	+5,187	+5,278	+5,369	+5,460	+5,551	+5,642	+5,733	+5,824	+5,915	+6,006
Group N	+5,614	+5,715	+5,815	+5,915	+6,015	+6,116	+6,216	+6,316	+6,416	+6,517	+6,617
Group O	+6,132	+6,242	+6,351	+6,461	+6,570	+6,680	+6,789	+6,899	+7,008	+7,118	+7,227
Group P	+6,636	+6,755	+6,873	+6,992	+7,110	+7,229	+7,347	+7,466	+7,584	+7,703	+7,821
Group Q	+7,658	+7,795	+7,932	+8,069	+8,205	+8,342	+8,479	+8,616	+8,752	+8,889	+9,026
Group R	+10,682	+10,873	+11,064	+11,255	+11,445	+11,636	+11,827	+12,018	+12,208	+12,399	+12,590
Group S	+11,466	+11,671	+11,876	+12,081	+12,285	+12,490	+12,695	+12,900	+13,104	+13,309	+13,514
Group T	+12,264	+12,483	+12,702	+12,921	+13,140	+13,359	+13,578	+13,797	+14,016	+14,235	+14,454
Group U	+13,062	+13,296	+13,529	+13,762	+13,995	+14,229	+14,462	+14,695	+14,928	+15,162	+15,395
Group V	+13,846	+14,094	+14,341	+14,588	+14,835	+15,083	+15,330	+15,577	+15,824	+16,072	+16,319
Group W	+14,644	+14,906	+15,167	+15,429	+15,690	+15,952	+16,213	+16,475	+16,736	+16,998	+17,259
Group X	+15,442	+15,718	+15,994	+16,270	+16,545	+16,821	+17,097	+17,373	+17,648	+17,924	+18,200
Group Y	+16,226	+16,516	+16,806	+17,096	+17,385	+17,675	+17,965	+18,255	+18,544	+18,834	+19,124
Group Z	+17,024	+17,328	+17,632	+17,936	+18,240	+18,544	+18,848	+19,152	+19,456	+19,760	+20,064

Upholstery Application Chart

• available

1 cane back version only

2 additional seams required

3 armless version only

Textile	Price Group	Brabo (Back and Seat)	Bumper	Clamshell	Crosshatch	Geiger Textiles Pillows	Rapport	Rapport Pillows	Reframe High-Back	Reframe Mid-Back	Reframe Wing-Back	Rolled Arm	Saiba	Scissor	Sled	Tuxedo Non Quilted	Tuxedo Quilted	U-Series	Washington Avenue	Wood Base
A Band Apart	Q	•	2	•	•		•	•						•	•	•	•		•	
Abacus	H	•	2	•	•		•	•				•		•	•	•	•	•	•	•
Abacus Standard	F	•	2	•	•							•		•	•	•	•		•	
Across	G	•	•	•	•		•	•				•		•	•	•	•	•	•	•
Agency	Q	•	2	•	•		•	•						•	•	•	•		•	
Akimbo	G	•	2	•	•							•		•	•				•	
All Grain Leather	R	•	•	•	•							•		•	•	•	•		•	
Allusion	8	•		•	•	•						•		•		•				
Alpaca Epinglé	N	•	•	•	•							•		•	•				•	
Alpaca Herringbone	L	•	2	•	•							•		•	•				•	
Alpaca Mohair	9			•	•	•								•	•				•	
Alpaca Velvet	N	•	•	•	•							•		•	•				•	
Alter	F	•	2	•	•		•	•				•		•	•	•	•		•	
Amenia	7	•	•	•	•	•	•	•				•	•	•	•	•	•	•	•	•
Anagram	H	•	2	•	•		•	•						•	•	•	•		•	
Ankara Cloth	10	•		•	•	•								•		•				
Antico	4	•	•	•	•				•	•		•	•	•	•	•	•		•	•
Apt	F	•	•	•	•	•	•	•				•	•	•	•	•	•	•	•	•
Article	E	•	•	•	•		•	•				•		•	•	•	•	•	•	•
Basketweave	8	•	•	•	•	•	•	•				•		•	•	•	•	•	•	•
Bateau	4	•		•	•	•	•	•				•		•	•	•	•		•	•
Bavaria	S	•	2	•	•		•	•						•	•	•	•	•	•	•
Bavaria Stripe	O	•	2	•	•		•	•						•	•	•	•		•	
Beam	H	•	2	•	•		•	•						•	•	•	•		•	
Bellano	7	•	•	•	•	•	•	•	•	•	•	•	•	•	•	•	•	•	•	•
Bento	3	•	•	•	•							•		•	•				•	
Bespoke Stripe	N	•	2	•	•		•	•						•	•	•	•		•	
Big Foot Leather	Z	•	•	•	•							•		•	•	•	•		•	
Big Stripe	P	•	2	•	•		•	•						•	•	•	•		•	
Blip	H	•	2	•	•		•	•				•		•	•	•	•	•	•	•

Upholstery Application Chart

• available

1 cane back version only

2 additional seams required

3 armless version only

Textile	Price Group	Brabo (Back and Seat)	Bumper	Clamshell	Crosshatch	Geiger Textiles Pillows	Rapport	Rapport Pillows	Reframe High-Back	Reframe Mid-Back	Reframe Wing-Back	Rolled Arm	Saiba	Scissor	Sled	Tuxedo Non Quilted	Tuxedo Quilted	U-Series	Washington Avenue	Wood Base
Blumen	L	•	2	•	•		•	•				•		•	•	•	•	•	•	•
Borders	R	•	2	•	•		•	•				•		•	•	•	•		•	•
Bouclé	5	•	•	•	•	•	•	•	•	•	•	•	•	•	•	•	•		•	•
Braid	4	•	2	•	•		•	•						•	•				•	•
Brindle	F			•	•	•	•	•				•		•		•	•		•	•
Bristol Leather	10	•	•	•	•		•	•	•	•		•	•	•	•	•	•	•	•	•
Brushed Camel	Q	•	•	•	•		•	•				•		•	•	•	•	•	•	•
Brushed Merino	P	•	•	•	•							•		•	•	•	•		•	•
Button-Up	5	•	•	•	•	•	•	•	•	•		•	•	•	•	•	•	•	•	•
Cambrai	3	•	•	•	•		•	•	•	•		•	•	•		•	•	•	•	•
Canon	2	•		•	•	•	•	•	•	•		•		•	•	•	•		•	•
Canvas	G	•	•	•	•		•	•				•		•	•	•	•	•	•	•
Capri	7	•	•	•	•	•	•	•	•	•		•	•	•		•	•	•	•	•
Centric	I	•	2	•	•		•	•				•		•	•	•	•	•	•	•
Checker	K	•	2	•	•		•	•						•	•	•	•	•	•	•
Checker Split	K	•	2	•	•		•	•						•	•	•	•	•	•	•
Chenille Cord	H	•	2	•	•		•	•						•	•	•			•	•
Cheswick	5	•	•	•	•	•	•	•	•	•		•	•	•	•	•	•		•	•
Circuit	G	•	•	•	•		•	•				•		•	•	•	•	•	•	•
Claremont	5	•	•	•	•	•	•	•				•		•		•	•		•	•
Classic Velvet	6	•	•	•	•	•						•		•	•			•		•
Coach Cloth	J	•	•	•	•							•		•		•	•		•	•
Coincide	F	•	2	•	•									•	•	•			•	•
Coincide High Performance	G	•	2	•	•		•	•						•	•	•			•	•
Colline	G	•	•	•	•				•	•	•	•		•	•	•			•	•
Colorwheel	I	•	2	•	•		•	•				•		•	•	•	•	•	•	•
Compartment	R	•	2	•	•		•	•						•		•	•		•	•
Corded Stripe	9	•		•	•	•								•		•			•	•
Corduroy Plaid	7	•		•	•	•	•	•				•		•					•	•
Couple	H	•	2	•	•		•	•						•	•	•	•		•	•

Upholstery Application Chart

• available

1 cane back version only

2 additional seams required

3 armless version only

Textile	Price Group	Brabo (Back and Seat)	Bumper	Clamshell	Crosshatch	Geiger Textiles Pillows	Rapport	Rapport Pillows	Reframe High-Back	Reframe Mid-Back	Reframe Wing-Back	Rolled Arm	Saiba	Scissor	Sled	Tuxedo Non Quilted	Tuxedo Quilted	U-Series	Washington Avenue	Wood Base
Crew	G	•	•	•	•		•	•				•		•	•	•	•		•	
Crossing	1	•	•	•	•		•	•				•		•	•	•	•	•	•	•
Crush	F	•	•	•	•		•	•				•		•	•	•	•		•	
Dapper	5	•	2	•	•		•	•						•	•	•	•	•	•	•
Dart	G	•	•	•	•		•	•				•		•	•	•	•	•	•	•
Deconstructed Rose	Q				•														•	
Derby	4	•	•	•	•		•	•				•		•		•	•	•	•	•
Design 9297	J	•	2	•	•		•	•				•		•	•	•	•	•	•	•
Dingbats	K	•	2	•	•		•	•				•		•	•	•	•		•	
Disperse	G	•	•	•	•		•	•		•		•		•	•	•	•	•	•	•
Ditto	H	•	2	•	•		•	•				•		•	•	•	•	•	•	•
Divina MD	H	•	•	•	•				•	•		•		•	•	•	•		•	
Dorset	7	•	•	•	•	•	•	•				•		•	•	•	•	•	•	•
Double Beam	7	•	•	•	•		•	•				•		•	•	•	•		•	
Double Beam Redux	7	•	•	•	•		•	•				•		•	•	•	•	•	•	•
Double Triangles	K	•	2	•	•							•		•	•	•	•		•	
Dream Cow Leather	R	•	•	•	•							•		•	•	•	•		•	
Dwell	E	•		•	•	•	•	•				•		•		•			•	
EcoHide Classic	4	•	•	•	•					•		•	•	•		•			•	•
EcoHide Vintage	5	•	•	•	•							•	•	•	•	•	•		•	•
Envie	5	•	•	•	•	•	•	•	•	•	•	•	•	•		•	•		•	•
Epinglé	7	•	•	•	•		•	•				•		•	•	•	•	•	•	•
Epinglé Stripe	P	•	2	•	•									•	•				•	
Essential Twill	5	•		•	•	•	•	•				•		•	•	•	•	•	•	•
Even	2	•		•	•	•	•	•	•	•		•		•	•	•	•		•	•
Exaggerated Plaid	L	•	2	•	•									•	•					
Exchange	F	•	2	•	•		•	•						•	•	•	•	•	•	•
Facets	K	•	2	•	•		•	•				•		•	•	•	•	•	•	•
Floret	G	•	•	•	•		•	•				•		•	•	•	•	•	•	•
Fluent Crypton	G	•	•	•	•							•		•	•	•	•		•	

Upholstery Application Chart

• available

1 cane back version only

2 additional seams required

3 armless version only

Textile	Price Group	Brabo (Back and Seat)	Bumper	Clamshell	Crosshatch	Geiger Textiles Pillows	Rapport	Rapport Pillows	Reframe High-Back	Reframe Mid-Back	Reframe Wing-Back	Rolled Arm	Saiba	Scissor	Sled	Tuxedo Non Quilted	Tuxedo Quilted	U-Series	Washington Avenue	Wood Base
Focus	E	•	•	•	•		•	•						•	•	•	•	•	•	
Foot Hills	8	•		•	•	•								•		•				
Free Range Leather	V	•	•	•	•							•		•	•	•	•		•	
Fringe	4	•	2	•	•		•	•						•		•		•	•	
Garden	I	•	2	•	•		•	•				•		•	•	•	•	•	•	
Geometri	L	•	2	•	•		•	•				•		•	•	•	•		•	
Granno	4	•	•	•	•		•	•		•		•	•	•	•	•	•		•	•
Graphon	7	•		•	•	•								•		•				
Gridwork	6	•		•	•	•								•		•			•	•
Hallingdal	J	•	•	•	•		•	•	•	•	•	•		•	•	•	•	•	•	
Harlow	5	•	•	•	•	•	•	•	•	•		•	•	•	•	•	•		•	•
Herman Miller Leather	9	•	•	•	•		•	•	•	•		•	•	•	•	•	•	•	•	
Herringbone	5	•	2	•	•		•	•								•				
Herringbone Stripe	N	•	2	•	•		•	•						•	•	•				
Hopsak	5	•	•	•	•		•	•	•	•		•	•	•	•	•	•	•	•	
Houndstooth Check	5	•	•	•	•	•	•	•				•		•	•	•	•	•	•	•
Hours	T	•	2	•	•									•	•				•	
Ingenué	5	•	•	•	•	•			•	•		•	•	•	•	•	•			
Iota	5	•	•	•	•	•	•		•	•		•	•	•	•	•	•	•	•	•
Iron Cloth	5	•		•	•	•								•					•	
Irregular Grid	4	•		•	•									•		•			•	
Jacobs Coat	L	•	2	•	•									•	•				•	
Kalista	4	•	•	•	•	•	•	•	•	•		•	•	•	•	•	•	•	•	•
Kindred	G	•	2	•	•		•	•						•	•	•	•		•	
Lanalux	14	•	•	•	•		•	•	•	•		•		•		•	•	•	•	
Layers Garden	P	•	•	•	•		•	•				•		•	•	•	•	•	•	
Layers Garden Double	U	•	•	•	•							•		•	•				•	
Layers Park	P	•	2	•	•		•	•				•		•	•	•	•	•	•	
Layers Park Double	U	•	2	•	•							•		•	•				•	
Layers Vineyard Large	P	•	2	•	•		•	•						•	•	•	•	•	•	

Upholstery Application Chart

• available

1 cane back version only

2 additional seams required

3 armless version only

Textile	Price Group	Brabo (Back and Seat)	Bumper	Clamshell	Crosshatch	Geiger Textiles Pillows	Rapport	Rapport Pillows	Reframe High-Back	Reframe Mid-Back	Reframe Wing-Back	Rolled Arm	Saiba	Scissor	Sled	Tuxedo Non Quilted	Tuxedo Quilted	U-Series	Washington Avenue	Wood Base
Layers Vineyard Small	P	•	2	•	•		•	•				•		•	•	•	•	•	•	
Letters	L	•	•	•	•							•		•	•					•
Linomix	11	•	•	•	•									•		•				•
Lucio	5	•		•	•							•		•		•				•
Manner	C	•	•	•	•		•	•	•	•		•		•	•	•	•	•	•	
Massive Paisley	Q	•	2	•	•		•	•						•	•	•	•	•	•	•
MCL Leather	11	•	•	•	•		•	•	•	•		•	•	•	•	•	•	•	•	•
Mechanism	H	•	•	•	•							•		•	•					•
Meld	3	•	•	•	•		•	•				•	•	•	•	•	•	•	•	•
Metallic Dream Cow Leather	R	•	•	•	•							•		•	•	•	•	•	•	•
Metric	C	•	•	•	•		•	•				•	•	•	•	•	•	•	•	•
Micro Houndstooth	4	•	•	•	•		•	•				•		•	•	•	•	•	•	•
Milaner	7	•	•	•	•	•	•	•	•	•	•	•	•	•		•	•	•	•	•
Milestone	C	•	•	•	•		•	•				•		•	•	•	•	•	•	•
Millerstripe	L	•	•	•	•		•	•						•	•	•				•
Mini Plaid	3	•	•	•	•		•	•						•		•		•		•
Minimal	F	•	•	•	•		•	•				•		•	•	•	•	•	•	•
Mister	H	•		•	•		•	•						•		•				•
Mode	D	•	•	•	•		•	•				•	•	•	•	•	•	•	•	•
Mohair Supreme	L	•	•	•	•		•	•				•		•	•	•		•	•	•
Moleskin Emboss	10	•		•	•		•	•				•		•		•		•	•	•
Murmur	C	•	•	•	•	•	•	•				•	•	•	•	•	•	•	•	•
Noble	5	•	•	•	•		•	•	•	•	•	•	•	•	•	•	•	•	•	•
Novello	4	•	•	•	•	•			•	•		•	•	•	•	•	•			•
Octave	H	•	2	•	•		•	•						•	•	•	•			•
Offset	H	•	2	•	•		•	•						•	•	•	•			•
Omen	G	•	2	•	•		•	•				•		•	•	•	•			•
Optik	K	•	2	•	•		•	•				•		•	•	•	•			•
Orakelblume	K	•	•	•	•		•	•				•		•	•	•	•	•	•	•
Ottoman	4	•	•	•	•	•	•	•	•	•	•	•	•	•	•	•	•	•	•	•

Upholstery Application Chart

• available

1 cane back version only

2 additional seams required

3 armless version only

Textile	Price Group	Brabo (Back and Seat)	Bumper	Clamshell	Crosshatch	Geiger Textiles Pillows	Rapport	Rapport Pillows	Reframe High-Back	Reframe Mid-Back	Reframe Wing-Back	Rolled Arm	Saiba	Scissor	Sled	Tuxedo Non Quilted	Tuxedo Quilted	U-Series	Washington Avenue	Wood Base
Ottoman Stripe	M	•	2	•	•		•	•						•	•	•	•		•	
Overture	6	•	•	•	•	•	•	•	•	•		•	•	•	•	•	•		•	•
Painted Stripe	K	•	2	•	•		•	•						•	•	•	•		•	
Panno Di Dolce	7	•	•	•	•	•	•	•	•	•	•	•	•	•	•	•	•	•	•	•
Pantile	7	•		•	•	•	•	•				•		•	•	•	•	•	•	•
Pare	G	•	•	•	•							•	•	•	•	•	•		•	•
Paver	G	•	•	•	•							•		•	•	•	•		•	
Piccolo	4	•	•	•	•	•	•	•	•			•	•	•		•	•	•	•	•
Pick-Stitch Plaid	6	•		•	•	•								•	•	•				•
Pinpoint	3	•	•	•	•									•	•				•	•
Pitch	F	•	•	•	•		•	•				•		•	•	•	•	•	•	
Pixel Stripe	5	•	2	•	•		•	•						•	•	•	•	•	•	•
Plait	F	•	•	•	•		•	•				•		•	•	•	•	•	•	
Point	N	•	•	•	•									•	•				•	
Pristina	7	•	•	•	•	•	•	•	•	•	•	•	•	•	•	•	•		•	
Regatta	H	•	•	•	•							•		•	•	•	•		•	
Renata	7	•	•	•	•	•	•	•	•	•		•	•	•	•	•	•		•	•
Repeat Classic Stripe	L	•		•	•									•	•	•			•	
Repeat Dot Ring	L	•	2	•	•		•	•				•		•	•	•	•	•	•	
Resca	7	•	•	•	•	•			•	•			•	•		•			•	•
Rove	F	•	•	•	•		•	•				•		•	•	•	•		•	
Rule	H	•		•	•		•	•						•		•	•		•	
Runner	G	•		•	•		•	•						•	•	•	•		•	
Runner Standard	F	•		•	•		•	•						•	•	•	•		•	
Saille	3	•	•	•	•	•	•	•	•	•		•	•	•	•	•	•	•	•	•
Salon	H	•	•	•	•		•	•				•		•		•	•	•	•	
Sateen Weave	7	•	•	•	•	•	•	•	•	•	•	•	•	•		•			•	•
Semplice Leather	8	•	•	•	•				•	•		•	•	•	•	•	•		•	•
Sequence	G	•	2	•	•		•	•				•		•	•	•			•	
Shuttle Standard	F	•	•	•	•									•	•	•			•	

Upholstery Application Chart

• available

1 cane back version only

2 additional seams required

3 armless version only

Textile	Price Group	Brabo (Back and Seat)	Bumper	Clamshell	Crosshatch	Geiger Textiles Pillows	Rapport	Rapport Pillows	Reframe High-Back	Reframe Mid-Back	Reframe Wing-Back	Rolled Arm	Saiba	Scissor	Sled	Tuxedo Non Quilted	Tuxedo Quilted	U-Series	Washington Avenue	Wood Base
Skein	F	•	2	•	•							•		•	•	•	•		•	
Soft Tweed	J	•	•	•	•		•	•				•		•	•	•	•		•	
Sommar	6	•	•	•	•	•	•	•				•		•	•	•	•	•	•	•
Staple	8	•	•	•	•	•						•		•					•	•
Starlet	8	•	•	•	•	•	•	•				•	•	•	•	•	•		•	•
Steady	F	•	•	•	•		•	•				•		•	•	•	•	•	•	•
Steady Crypton	G	•	•	•	•							•		•	•	•	•		•	
Steelcut	G	•	•	•	•		•	•	•	•		•		•	•	•	•	•	•	•
Steelcut Trio	H	•	•	•	•		•	•	•	•		•		•		•	•	•	•	•
Straightaway	5	•	•	•	•											•			•	•
Strand	G	•	•	•	•		•	•				•		•	•	•	•		•	
Strata	4	•	•	•	•		•	•				•		•		•	•	•	•	•
Striae	5	•			•		•	•				•		•	•	•	•		•	•
Stripes	L	•	2	•	•		•	•						•	•	•	•		•	
Striscia	8	•		•	•	•								•		•			•	•
Superweave	10	•	•	•	•		•	•				•		•		•	•	•	•	•
Tangram	J	•	2	•	•		•	•						•	•	•	•		•	
Tattersall Reverse	6	•	2	•	•							•		•	•	•			•	
Telary	J	•	2	•	•		•	•				•		•	•	•	•		•	
Tenera Leather	11	•	•	•	•		•	•	•	•		•	•	•	•	•	•	•	•	•
Tenon	5	•	•	•	•	•	•	•	•	•		•	•	•	•	•	•		•	
The Firm	Q	•	2	•	•		•	•						•	•	•	•	•	•	•
The Story of My Life	L	•	2	•	•		•	•				•		•	•	•	•	•	•	•
Threads	5	•	•	•	•		•	•				•		•	•	•	•	•	•	•
Tonica	G	•	•	•	•		•	•	•	•	•	•		•	•	•	•	•	•	•
Tonus	H	•	•	•	•		•	•	•	•	•	•	•	•	•	•	•	•	•	•
Toostripe	L	•	2	•	•		•	•						•	•	•	•		•	
Trait	F	•	•	•	•		•	•				•		•	•	•	•	•	•	•
Transport	J	•		•	•							•		•	•	•			•	
Trees	K	•	2	•	•		•	•				•		•	•	•	•		•	

Upholstery Application Chart

• available

1 cane back version only

2 additional seams required

3 armless version only

Textile	Price Group	Brabo (Back and Seat)	Bumper	Clamshell	Crosshatch	Geiger Textiles Pillows	Rapport	Rapport Pillows	Reframe High-Back	Reframe Mid-Back	Reframe Wing-Back	Rolled Arm	Saiba	Scissor	Sled	Tuxedo Non Quilted	Tuxedo Quilted	U-Series	Washington Avenue	Wood Base
Trio	1	•	2	•	•		•	•				•		•	•	•	•	•	•	•
True Herringbone	7	•	•	•	•	•								•	•	•			•	•
Tweed Stripe	3	•	•	•	•	•	•	•						•	•				•	•
Twill Plaid	7	•		•	•	•								•	•	•			•	•
Twist	2	•	•	•	•		•	•	•	•		•		•	•	•	•	•	•	•
Unisol	K	•	2	•	•		•	•						•	•	•			•	•
Urban	G	•	2	•	•		•	•						•	•	•			•	•
Vaquero	5	•	•	•	•				•	•		•	•	•	•	•	•		•	•
Vases	1	•	•	•	•		•	•				•		•	•	•	•		•	•
Vavare	5	•		•	•	•	•	•				•		•	•	•	•	•	•	•
Velvet Plaid	7	•	2	•	•	•	•	•				•		•	•	•			•	•
Vesture	7	•	•	•	•	•	•	•	•	•		•		•	•	•	•	•	•	•
Vineyard	1	•	2	•	•		•	•				•		•	•	•	•	•	•	•
Vionette	5	•	•	•	•	•	•	•	•	•		•	•	•	•	•	•		•	•
Voyage	1	•		•	•		•	•				•		•	•	•	•	•	•	•
Waterborn	J	•		•	•		•	•				•		•		•	•	•	•	•
Wool Epinglé	7	•	2	•	•	•	•	•				•		•	•	•	•	•	•	•
Wool Rib	J	•	•	•	•							•		•	•	•			•	•
Wool Satin	7	•	•	•	•		•	•	•	•		•		•	•	•			•	•
Wool Tweed	7	•	•	•	•	•	•	•	•	•		•		•	•	•	•	•	•	•
Wool Velvet	N	•	•	•	•							•		•	•	•	•		•	•

Wood Finishes					
Code	Description	Ash	Walnut	Rolled Arm	Tuxedo
662	Toasted Walnut, matte	•	•	W	W
663	Charred Walnut, matte	•	•	W	W
664	Bronzed Walnut, matte	•	•	W	W
665	Smoked Walnut, matte	•	•	W	W
666	Coffee Walnut, matte	•	•	W	W
667	Smoked Paldao, matte	•	•	W	W
669	Warm Paldao, matte	•	•	W	W
677	Chocolate Ash, matte	•		A	A
66A	RecoGrain Frosty Ash, matte	•		A	A
66G	RecoGrain Wenge, matte	•	•	W	W
66W	RecoGrain Walnut, Matte	•		A	A
68R	RecoGrain Rosewood, matte	•	•	W	W
68W	RecoGrain Walnut, Matte	•		A	A
69A	RecoGrain Frosty Ash, matte	•		A	A
69G	RecoGrain Wenge, matte	•	•	W	W
69R	RecoGrain Rosewood, matte	•	•	W	W
69T	RecoGrain Teak, matte	•		A	A
69W	RecoGrain Walnut, Matte	•		A	A
6A1	White Ash, matte	•		A	A
6ET	RecoGrain Natural Ash, Ash Solid, matte	•		A	A
6EU	RecoGrain Oak, Oak Solid, matte	•		A	A
6EV	RecoGrain Walnut, Walnut Solid, matte	•	•	W	W
6K1	Rift Oak, matte	•		A	A
6K6	Burnt Oak, matte	•		A	A
940	Sundance Cherry on Maple, low sheen	•		A	A
943	Caramel Cherry, low sheen	•		A	A
946	Cocoa Cherry, Low Sheen	•		A	A
956	Cocoa Sapele, low sheen	•		A	A
962	Toasted Walnut, low sheen	•	•	W	W
963	Charred Walnut, low sheen	•	•	W	W
964	Bronzed Walnut, low sheen	•	•	W	W
965	Smoked Walnut, low sheen	•	•	W	W
966	Coffee Walnut, low sheen	•	•	W	W
967	Smoked Paldao, low sheen	•	•	W	W
969	Warm Paldao, low sheen	•	•	W	W
972	Sundance Walnut, low sheen		•	W	W
977	Chocolate Ash, low sheen	•		A	A
991	Champagne Ash, low sheen	•		A	A
998	Ebony Ash, low sheen	•		A	A
96A	RecoGrain Frosty Ash, low sheen	•		A	A
96G	RecoGrain Wenge, low sheen	•	•	W	W
96W	RecoGrain Walnut, Low Sheen	•		A	A

Notes

Brabo has a metal and solid ash or walnut wood frame. When a stained wood finish is specified, the solid ash or walnut wood is stained to match the color of the selected finish.

Clamshell has a veneered molded plywood back in either ash or walnut. When a stained wood finish is specified, the veneer is stained to match the color of the selected finish.

Crosshatch and Reframe have a solid ash or walnut wood frame. When a stained wood finish is specified, the solid ash or walnut wood is stained to match the color of the selected finish.

Rolled Arm legs are either solid ash or walnut. When a stained wood finish is specified, the table is stained to match the color of the selected finish. The solid used is either ash (A) or walnut (W) depending on the finish selected.

Scissor has a metal or solid ash wood frame. When a stained wood finish is specified, the solid ash wood is stained to match the color of the selected finish.

Tuxedo side tables have an ash or walnut wood table. When a stained wood finish is specified, the table is stained to match the color of the selected finish. The veneer used is either ash (A) or walnut (W) depending on the finish selected.

Appropriate hardwoods are selected to provide a product that will stand up to normal office use and perform under Geiger's 12-year warranty. In certain situations other hardwoods may be appropriate and Geiger will evaluate their use for orders over 100 units.

Special finishes can be developed for seating on a minimum order of 100 chairs at no additional charge. For seating orders under 100 chairs, special finishes may be developed for a one-time set-up fee of \$250 net per finish.

For additional information and procedures for special hardwoods or finishes, contact your Geiger sales representative or Geiger Customer Care at 800.456.6452.

Wood Finishes

Code	Description	Ash	Walnut	Rolled Arm	Tuxedo
98R	RecoGrain Rosewood, low sheen	•	•	W	W
98W	RecoGrain Walnut, Low Sheen	•		A	A
99A	RecoGrain Frosty Ash, low sheen	•		A	A
99G	RecoGrain Wenge, low sheen	•	•	W	W
99R	RecoGrain Rosewood, low sheen	•	•	W	W
99T	RecoGrain Teak, low sheen	•		A	A
99W	RecoGrain Walnut, Low Sheen	•		A	A
9A1	White Ash, low sheen	•		A	A
9K1	Rift Oak, low sheen	•		A	A
9K6	Burnt Oak, low sheen	•		A	A
ED	Aged Cherry, low sheen	•		A	A
EK	Medium Red Walnut, low sheen	•	•	W	W
ET	RecoGrain Ash, matte	•		A	A
EU	RecoGrain Oak, matte	•		A	A
EV	RecoGrain Walnut, matte	•	•	W	W
G2U	Light Brown Walnut, low sheen	•	•	W	W
G40	Dark Brown Walnut, low sheen	•	•	W	W
GOU	Walnut, matte	•	•	W	W
UX	Walnut On Cherry, low sheen	•		A	A

	Product Number	Depth	Width	Height	Basic Price	Upholstery
Brabo • Lounge Chair 	ash frame SVV4A	33	26 5/8	29 1/4	\$2,790	<i>Basic/COM Price does not include fabric. Refer to the upholstery upcharge pages for fabric and COL pricing. 1 yard = 18 sq. ft.</i>
	walnut frame SVV4W	33	26 5/8	29 1/4	\$3,350	
<p>COM/COL (Seat and Back) 2 yards, 36 sq. ft. COM/COL (Sling and Arm) 1.5 yards Wood Frame solid ash or walnut Metal Frame steel plated Seat height 15 1/8" Arm height 22" Seat HR foam, Dacron, and polyfoam cushions</p> <p>Note: COM/COL is not available on Brabo sling and arm. Sling and arm are ONLY available in Bristol, MCL, or Tenera Leather. COM/COL requirements provided only for pricing lookup for Bristol, MCL, and Tenera leathers in the upholstery pricing section.</p>						

Specify

- Wood
- Upholstery 1 (back and seat cushion)
- Upholstery 2 (sling and arm leather, only available in Bristol, MCL, and Tenera leather)
- Base Finish
- Fire Retardancy (specify NOCAL)

	Product Number	Depth	Width	Height	Basic Price	Upholstery
Brabo • Settee 	ash frame SVV5A	33	50 5/8	29 1/4	\$5,010	<i>Basic/COM Price does not include fabric. Refer to the upholstery upcharge pages for fabric and COL pricing. 1 yard = 18 sq. ft.</i>
	walnut frame SVV5W	33	50 5/8	29 1/4	\$5,230	
COM/COL (Seat and Back) 4 yards, 72 sq. ft. COM/COL (Sling and Arm) 3 yards Wood Frame solid ash or walnut Metal Frame steel plated Seat height 15 1/8" Arm height 22 Seat HR foam, Dacron, and polyfoam cushions						

Note: COM/COL is not available on Brabo sling and arm. Sling and arm are ONLY available in Bristol, MCL, or Tenera Leather. COM/COL requirements provided only for pricing lookup for Bristol, MCL, and Tenera leathers in the upholstery pricing section.

Specify

- Wood
- Upholstery 1 (back and seat cushion)
- Upholstery 2 (sling and arm leather, only available in Bristol, MCL, and Tenera leather)
- Base Finish
- Fire Retardancy (specify NOCAL)

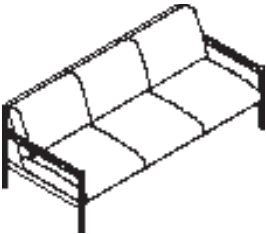
	Product Number	Depth	Width	Height	Basic Price	Upholstery
Brabo • Sofa	<i>ash frame</i> SVV6A	33	74 1/2	29 1/4	\$6,700	<i>Basic/COM Price does not include fabric. Refer to the upholstery upcharge pages for fabric and COL pricing. 1 yard = 18 sq. ft.</i>
	<i>walnut frame</i> SVV6W	33	74 1/2	29 1/4	\$6,985	
	<i>COM/COL (Seat and Back) 6 yards, 108 sq. ft.</i>					
	<i>COM/COL (Sling and Arm) 4.5 yards</i>					
	<i>Wood Frame solid ash or walnut</i>					
	<i>Metal Frame steel plated</i>					
	<i>Seat height 15 1/8"</i>					
	<i>Arm height 22"</i>					
	<i>Seat HR foam, Dacron, and polyfoam cushions</i>					

Note: COM/COL is not available on Brabo sling and arm. Sling and arm are ONLY available in Bristol, MCL, or Tenera Leather. COM/COL requirements provided only for pricing lookup for Bristol, MCL, and Tenera leathers in the upholstery pricing section.

Specify

- Wood
- Upholstery 1 (back and seat cushion)
- Upholstery 2 (sling and arm leather, only available in Bristol, MCL, and Tenera leather)
- Base Finish
- Fire Retardancy (specify NOCAL)

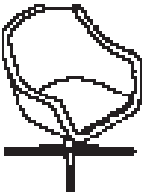
	Product Number	Depth	Width	Height	Basic Price	Upholstery
Bumper	SBR4N	28	27	31 1/2	\$2,020	<i>Basic/COM Price does not include fabric. Refer to the upholstery upcharge pages for fabric and COL pricing. 1 yard = 18 sq. ft.</i>
	<p>COM/COL (shell) 2 1/2 yards, 45 sq. ft. COM/COL (arm cap & cushion)..... 1 3/4 yards, 31 1/2 sq. ft. Seat height 17" Arm height 24 1/2" Base cast aluminum with black glides Frame rigid molded urethane with foam inserts Seat & back HR foam over rigid insert</p>					

Specify



- Wood
- Upholstery 1 (shell, inside and outside)
- Upholstery 2 (arm cap and cushion)
- Base Finish (available only in CD polished aluminum)
- Fire Retardancy (specify NOCAL)

	Product Number	Depth	Width	Height	Basic Price	Upholstery
Clamshell <i>low back, armless</i> 	<i>ash shell</i> SSJFA	26 3/4	22 1/4	28 3/4	\$2,670	<i>Basic/COM Price does not include fabric. Refer to the upholstery upcharge pages for fabric and COL pricing. 1 yard = 18 sq. ft.</i>
	<i>quarter-cut walnut shell</i> SSJFW	26 3/4	22 1/4	28 3/4	\$2,795	
	<i>flat-cut walnut shell</i> SSJFF	26 3/4	22 1/4	28 3/4	\$2,910	
<i>COM/COL..... 1 yard, 18 sq. ft.</i> <i>Seat height 17"</i> <i>Shell..... veneered molded plywood in ash or walnut</i> <i>Legs..... solid ash or walnut in same species as shell</i> <i>Seat, back..... HR foam over rigid insert</i>						

Clamshell <i>low back, with arms</i> 	<i>ash shell</i> SSJGA	26 3/4	26 3/4	28 3/4	\$2,880	<i>Basic/COM Price does not include fabric. Refer to the upholstery upcharge pages for fabric and COL pricing. 1 yard = 18 sq. ft.</i>
	<i>quarter-cut walnut shell</i> SSJGW	26 3/4	26 3/4	28 3/4	\$3,005	
	<i>flat-cut walnut shell</i> SSJGF	26 3/4	26 3/4	28 3/4	\$3,125	
<i>COM/COL..... 1 yard, 18 sq. ft.</i> <i>Seat height 17"</i> <i>Arms 24 1/4", solid wood in same species as shell</i> <i>Shell..... veneered molded plywood in ash or walnut</i> <i>Legs..... solid ash or walnut in same species as shell</i> <i>Seat, back..... HR foam over rigid insert</i>						

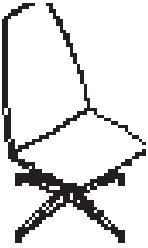

Specify

Wood
 Upholstery
 Fire Retardancy (specify NOCAL)

	Product Number	Depth	Width	Height	Basic Price	Upholstery
Clamshell <i>high back, armless</i> 	<i>ash shell</i> SSJJA	27	22 1/4	39 3/4	\$2,400	<i>Basic/COM Price does not include fabric. Refer to the upholstery upcharge pages for fabric and COL pricing. 1 yard = 18 sq. ft.</i>
	<i>quarter-cut walnut shell</i> SSJJW	27	22 1/4	39 3/4	\$2,525	
	<i>flat-cut walnut shell</i> SSJJF	27	22 1/4	39 3/4	\$2,645	
	<i>COM/COL..... 1 1/2 yards, 27 sq. ft.</i> <i>Seat height 17"</i> <i>Shell..... veneered molded plywood in ash or walnut</i> <i>Seat, back..... HR foam over rigid insert</i> <i>Metal base four star, polished aluminum swivel base on black glides</i>					
Clamshell <i>high back, with arms</i> 	<i>ash shell</i> SSJKA	27	26 3/4	39 3/4	\$2,615	<i>Basic/COM Price does not include fabric. Refer to the upholstery upcharge pages for fabric and COL pricing. 1 yard = 18 sq. ft.</i>
	<i>quarter-cut walnut shell</i> SSJKW	27	26 3/4	39 3/4	\$2,730	
	<i>flat-cut walnut shell</i> SSJKF	27	26 3/4	39 3/4	\$2,850	
	<i>COM/COL..... 1 1/2 yards, 27 sq. ft.</i> <i>Seat height 17"</i> <i>Arms 24 1/4", solid wood in same species as shell</i> <i>Shell..... veneered molded plywood in ash or walnut</i> <i>Seat, back..... HR foam over rigid insert</i> <i>Metal base four star, polished aluminum swivel base on black glides</i>					

Specify

Wood
 Upholstery
 Base Finish (available only in CD polished aluminum)
 Fire Retardancy (specify NOCAL)

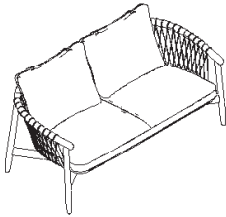
	Product Number	Depth	Width	Height	Basic Price	Upholstery
Crosshatch • Chair 	ash frame SES1A	30 1/4	31 1/4	28 1/2	\$2,785	<i>Basic/COM Price does not include fabric. Refer to the upholstery upcharge pages for fabric and COL pricing. 1 yard = 18 sq. ft.</i>
	walnut frame SES1W	30 1/4	31 1/4	28 1/2	\$3,315	
	COM/COL..... 1 1/2 yards, 27 sq. ft. Seat height 14 3/4" Arm height 22 1/2" Frame solid ash or walnut Cushion HR foam and Dacron					
Crosshatch • Ottoman 	ash SES3A	16	23	13 3/4	\$1,075	<i>Basic/COM Price does not include fabric. Refer to the upholstery upcharge pages for fabric and COL pricing. 1 yard = 18 sq. ft.</i>
	walnut SES3W	16	23	13 3/4	\$1,240	
	COM/COL..... 3/4 yards, 13 1/2 sq. ft. Frame solid ash or walnut Cushion HR foam and Dacron					
Crosshatch • Settee 	ash SES4A	30 1/4	62	28 1/2	\$4,045	<i>Basic/COM Price does not include fabric. Refer to the upholstery upcharge pages for fabric and COL pricing. 1 yard = 18 sq. ft.</i>
	walnut SES4W	30 1/4	62	28 1/2	\$4,660	
	COM/COL..... 4 1/2 yards, 81 sq. ft. Seat height 14 3/4" Arm height 22 1/2" Frame solid ash or walnut Cushion HR foam and Dacron					

Specify

Wood
 Upholstery
 Fire Retardancy (specify NOCAL)
 Cord (chair and settee)

	Product Number	Depth	Width	Height	Basic Price	Upholstery
Pillows Geiger Textiles	PTA	6"	9"	18"	\$150	<i>Basic Price does not include fabric. Add textile upcharge listed below.</i>
	PTB	6"	18"	18"	\$180	
	PTC	6"	10 1/2"	21"	\$160	
	PTD	6"	21"	21"	\$225	



Price Group	Fabric Upcharge Per Pillow
1	+\$21
2	+\$25
3	+\$31
4	+\$38
5	+\$55
6	+\$72
7	+\$89
8	+\$135
9	+\$168
10	+\$193
11	+\$216
12	+\$247
13	+\$255
14	+\$283
A	+\$17
B	+\$20
C	+\$28
D	+\$37
E	+\$44
F	+\$53

Price Group	Fabric Upcharge Per Pillow
G	+\$72
H	+\$90
I	+\$108
J	+\$127
K	+\$145
L	+\$164
M	+\$182
N	+\$201
O	+\$219
P	+\$237
Q	+\$274
R	+\$382
S	+\$410
T	+\$438
U	+\$467
V	+\$495
W	+\$523
X	+\$552
Y	+\$580
Z	+\$608

Specify

Upholstery*

**Available only in limited fabrics. Not available in COM/COL.
Pillows are filled with 95% duck down feathers.
Depth is approximate based on how much the pillow is fluffed.*

	Product Number	Depth	Width	Height	Basic Price	Upholstery
--	----------------	-------	-------	--------	-------------	------------

Rapport • Corner Unit	SK1	35 1/2	35 1/2	26 3/4	\$3,195	<i>Basic/COM Price does not include fabric. Refer to the upholstery upcharge pages for fabric and COL pricing. 1 yard = 18 sq. ft.</i>
------------------------------	------------	--------	--------	--------	---------	--

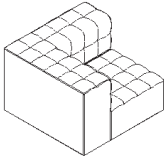

COM/COL..... 5 yards, 90 sq. ft.
Seat height 15"
Arm height 26 3/4"
Base solid ash or walnut
Cushion foam and Dacron

Specify

Upholstery
Base Finish
Fire Retardancy (specify NOCAL)

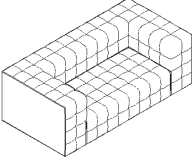
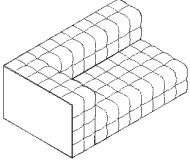
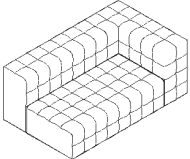
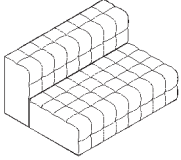
	Product Number	Depth	Width	Height	Basic Price	Upholstery
Rapport • Settee with arms 	SK2A	35 3/8	70 7/8	26 3/4	\$5,245	<i>Basic/COM Price does not include fabric. Refer to the upholstery upcharge pages for fabric and COL pricing. 1 yard = 18 sq. ft.</i>
		COM/COL..... 9 1/2 yards, 171 sq. ft. Seat height 15" Arm height 26 3/4" Base solid ash or walnut Cushion foam and Dacron				
Rapport • Settee arm right, connection left 	SK2CL	35 3/8	59	26 3/4	\$5,195	<i>Basic/COM Price does not include fabric. Refer to the upholstery upcharge pages for fabric and COL pricing. 1 yard = 18 sq. ft.</i>
		COM/COL..... 7 1/2 yards, 135 sq. ft. Seat height 15" Arm height 26 3/4" Base solid ash or walnut Cushion foam and Dacron				
Rapport • Settee arm left, connection right 	SK2CR	35 3/8	59	26 3/4	\$5,195	<i>Basic/COM Price does not include fabric. Refer to the upholstery upcharge pages for fabric and COL pricing. 1 yard = 18 sq. ft.</i>
		COM/COL..... 7 1/2 yards, 135 sq. ft. Seat height 15" Arm height 26 3/4" Base solid ash or walnut Cushion foam and Dacron				
Rapport • Settee armless 	SK2N	35 3/8	47 1/4	26 3/4	\$4,595	<i>Basic/COM Price does not include fabric. Refer to the upholstery upcharge pages for fabric and COL pricing. 1 yard = 18 sq. ft.</i>
		COM/COL..... 5 1/4 yards, 94 1/2 sq. ft. Seat height 15" Base solid ash or walnut Cushion foam and Dacron				

Specify

Upholstery
 Base Finish
 Fire Retardancy (specify NOCAL)

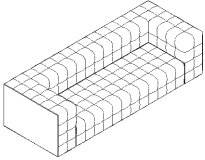
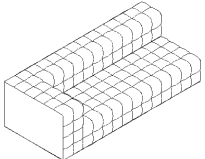
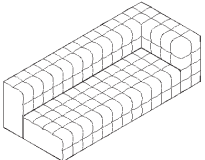
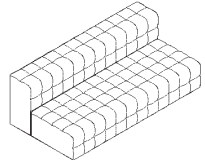
	Product Number	Depth	Width	Height	Basic Price	Upholstery
Rapport • Sofa with arms 	SK3A	35 3/8	94 1/2	26 3/4	\$6,095	<i>Basic/COM Price does not include fabric. Refer to the upholstery upcharge pages for fabric and COL pricing. 1 yard = 18 sq. ft.</i>
		COM/COL..... 10 3/4 yards, 193 1/2 sq. ft. Seat height 15" Arm height 26 3/4" Base solid ash or walnut Cushion foam and Dacron				
Rapport • Sofa arm right, connection left 	SK3CL	35 3/8	82 5/8	26 3/4	\$6,045	<i>Basic/COM Price does not include fabric. Refer to the upholstery upcharge pages for fabric and COL pricing. 1 yard = 18 sq. ft.</i>
		COM/COL..... 8 3/4 yards, 157 1/2 sq. ft. Seat height 15" Arm height 26 3/4" Base solid ash or walnut Cushion foam and Dacron				
Rapport • Sofa arm left, connection right 	SK3CR	35 3/8	82 5/8	26 3/4	\$6,045	<i>Basic/COM Price does not include fabric. Refer to the upholstery upcharge pages for fabric and COL pricing. 1 yard = 18 sq. ft.</i>
		COM/COL..... 8 3/4 yards, 157 1/2 sq. ft. Seat height 15" Arm height 26 3/4" Base solid ash or walnut Cushion foam and Dacron				
Rapport • Sofa armless 	SK3N	35 3/8	70 7/8	26 3/4	\$5,445	<i>Basic/COM Price does not include fabric. Refer to the upholstery upcharge pages for fabric and COL pricing. 1 yard = 18 sq. ft.</i>
		COM/COL..... 7 1/4 yards, 130 1/2 sq. ft. Seat height 15" Base solid ash or walnut Cushion foam and Dacron				

Specify

Upholstery
 Base Finish
 Fire Retardancy (specify NOCAL)

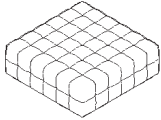
	Product Number	Depth	Width	Height	Basic Price	Upholstery
Rapport • Ottoman <i>small</i> 	SK4A	35 1/2	35 1/2	15	\$2,395	<i>Basic/COM Price does not include fabric. Refer to the upholstery upcharge pages for fabric and COL pricing. 1 yard = 18 sq. ft.</i>
		<i>COM/COL..... 2 3/4 yards, 49 1/2 sq. ft.</i> <i>Base solid ash or walnut</i> <i>Cushion foam and Dacron</i>				

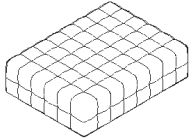
Rapport • Ottoman <i>large</i> 	SK4B	35 1/2	47 1/4	15	\$2,595	<i>Basic/COM Price does not include fabric. Refer to the upholstery upcharge pages for fabric and COL pricing. 1 yard = 18 sq. ft.</i>
		<i>COM/COL..... 3 3/4 yards, 67 1/2 sq. ft.</i> <i>Base solid ash or walnut</i> <i>Cushion foam and Dacron</i>				

Specify

- Upholstery*
- Base Finish*
- Fire Retardancy (specify NOCAL)*

	Product Number	Depth	Width	Height	Basic Price	Upholstery
Rapport • Pillow small	SK6	4	18	18	\$180	<i>Basic Price does not include fabric. Add textile upcharge listed below.</i>



COM/COL..... 1 yard, 18 sq. ft.

Price Group	Fabric Upcharge Per Pillow
1	+\$41
2	+\$49
3	+\$61
4	+\$75
5	+\$109
6	+\$143
7	+\$177
8	+\$270
9	+\$335
10	+\$386
11	+\$432
12	+\$493
13	+\$510
14	+\$566
A	+\$34
B	+\$39
C	+\$55
D	+\$73
E	+\$88
F	+\$106

Price Group	Fabric Upcharge Per Pillow
G	+\$144
H	+\$179
I	+\$216
J	+\$253
K	+\$290
L	+\$327
M	+\$364
N	+\$401
O	+\$438
P	+\$474
Q	+\$547
R	+\$763
S	+\$819
T	+\$876
U	+\$933
V	+\$989
W	+\$1,046
X	+\$1,103
Y	+\$1,159
Z	+\$1,216

Specify

Upholstery*

**Available only in limited fabrics. Not available in COM/COL.
Pillows are filled with 95% duck down feathers.
Depth is approximate based on how much the pillow is fluffed.*

	Product Number	Depth	Width	Height	Basic Price	Upholstery
Rapport • Pillow large	SK5	4	21	31	\$250	<i>Basic Price does not include fabric. Add textile upcharge listed below.</i>



COM/COL..... 1 1/2 yards, 27 sq. ft.



Price Group	Fabric Upcharge Per Pillow
1	+\$62
2	+\$74
3	+\$92
4	+\$113
5	+\$164
6	+\$215
7	+\$266
8	+\$405
9	+\$503
10	+\$579
11	+\$648
12	+\$740
13	+\$765
14	+\$849
A	+\$51
B	+\$59
C	+\$83
D	+\$110
E	+\$132
F	+\$159

Price Group	Fabric Upcharge Per Pillow
G	+\$216
H	+\$269
I	+\$324
J	+\$380
K	+\$435
L	+\$491
M	+\$546
N	+\$602
O	+\$657
P	+\$711
Q	+\$821
R	+\$1,145
S	+\$1,229
T	+\$1,314
U	+\$1,400
V	+\$1,484
W	+\$1,569
X	+\$1,655
Y	+\$1,739
Z	+\$1,824

Specify

Upholstery*

**Available only in limited fabrics. Not available in COM/COL.
Pillows are filled with 95% duck down feathers.
Depth is approximate based on how much the pillow is fluffed.*

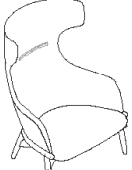
	Product Number	Depth	Width	Height	Basic Price	Upholstery
Reframe Mid-Back 	ash frame SJAA	32 1/8"	31 1/4"	30 3/8"	\$2,685	<i>Basic/COM Price does not include fabric. Refer to the upholstery upcharge pages for fabric and COL pricing. 1 yard = 18 sq. ft.</i>
	walnut frame SJAW	32 1/8"	31 1/4"	30 3/8"	\$3,185	
	COM/COL..... 3 1/2 yards, 63 sq. ft. Seat Height..... 16 5/8" Inside Arm Width 23" Seat rigid and soft polyurethane foam Frame solid ash or walnut					
Reframe High-Back 	ash frame SJBA	33 3/8"	31 1/4"	38 3/4"	\$2,840	<i>Basic/COM Price does not include fabric. Refer to the upholstery upcharge pages for fabric and COL pricing. 1 yard = 18 sq. ft.</i>
	walnut frame SJBW	33 3/8"	31 1/4"	38 3/4"	\$3,340	
	COM/COL..... 3 3/4 yards, 67.5 sq. ft. Seat Height..... 16 5/8" Inside Arm Width 23" Seat rigid and soft polyurethane foam Frame solid ash or walnut					
Reframe Wing-Back 	ash frame SJCA	33 1/2"	31 1/4"	45 1/4"	\$3,040	<i>Basic/COM Price does not include fabric. Refer to the upholstery upcharge pages for fabric and COL pricing. 1 yard = 18 sq. ft.</i>
	walnut frame SJCW	33 1/2"	31 1/4"	45 1/4"	\$3,540	
	COM/COL..... 4 1/4 yards, 76.5 sq. ft. Seat Height..... 16 5/8" Inside Arm Width 23" Seat rigid and soft polyurethane foam Frame solid ash or walnut					

Specify

Wood Finish
 Upholstery
 Fire Retardancy (specify NOCAL)

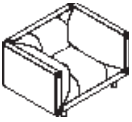
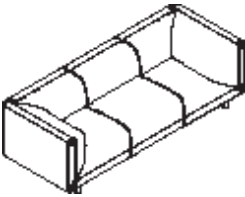
	Product Number	Depth	Width	Height	Basic Price	Upholstery
Rolled Arm Chair 	SBRA-43	32 1/2	43	24 3/4	\$3,555	<i>Basic/COM Price does not include fabric. Refer to the upholstery upcharge pages for fabric and COL pricing. 1 yard = 18 sq. ft.</i>
	<p>COM/COL..... 6 yards, 108 sq. ft. Seat height 16" Arm Height..... 24 3/4" Seat, back..... plywood with HR foam and Dacron Arms HR foam, Dacron, and polyfoam Legs..... solid wood in select walnut or ash finishes</p>					
Rolled Arm Sofa 	SBRA-72	32 1/2	72	24 3/4	\$4,980	<i>Basic/COM Price does not include fabric. Refer to the upholstery upcharge pages for fabric and COL pricing. 1 yard = 18 sq. ft.</i>
	<p>COM/COL..... 9 yards, 162 sq. ft. Seat height 16" Arm Height..... 24 3/4" Seat, back..... plywood with HR foam and Dacron Arms HR foam, Dacron, and polyfoam Legs..... solid wood in select walnut or ash finishes</p>					
	SBRA-84	32 1/2	84	24 3/4	\$5,215	<i>Basic/COM Price does not include fabric. Refer to the upholstery upcharge pages for fabric and COL pricing. 1 yard = 18 sq. ft.</i>
	<p>COM/COL..... 11 yards, 198 sq. ft. Seat height 16" Arm Height..... 24 3/4" Seat, back..... plywood with HR foam and Dacron Arms HR foam, Dacron, and polyfoam Legs..... solid wood in select walnut or ash finishes</p>					
	SBRA-96	32 1/2	96	24 3/4	\$5,630	<i>Basic/COM Price does not include fabric. Refer to the upholstery upcharge pages for fabric and COL pricing. 1 yard = 18 sq. ft.</i>
	<p>COM/COL..... 12 1/2 yards, 225 sq. ft. Seat height 16" Arm Height..... 24 3/4" Seat, back..... plywood with HR foam and Dacron Arms HR foam, Dacron, and polyfoam Legs..... solid wood in select walnut or ash finishes</p>					

Specify

Wood (legs)
 Upholstery
 Fire Retardancy (specify NOCAL)

	Product Number	Depth	Width	Height	Basic Price	Upholstery
Saiba <i>lounge, high-back</i> 	SBN5H	32	30 1/2	32 1/2	\$2,790	<i>Basic/COM Price does not include fabric. Refer to the upholstery upcharge pages for fabric and COL pricing. 1 yard = 18 sq. ft.</i>
	<i>Fabric Req. 3 1/2 yards, 63 sq. ft.</i> <i>Shell.....rigid urethane with polyurethane foam</i> <i>Base4-star die cast aluminum with black glides, swivels</i> <i>Seat height 16 1/4"</i> <i>Seat depth 19 1/4"</i> <i>Arm height 19 3/4"</i> <i>Cushionhigh density HR foam</i>					

Specify

Upholstery (not available in Bristol leather 5-597 Pure)
Base Finish
Fire Retardancy (specify NOCAL)

Note: Saiba lounge chair requires an additional 3.5 yards of fabric / 63 sq. ft. of leather for testing for all COM/COL orders, plus the standard memo-sized sample.

	Product Number	Depth	Width	Height	Basic Price	Upholstery
Saiba ottoman 	SBN6	19 1/4	25 1/4	17 1/2	\$1,110	<i>Basic Price does not include fabric. Refer to the upholstery upcharge pages for fabric pricing. 1 yard = 18 sq. ft.</i> <i>Not available with COM or COL</i>
	<i>Fabric Req. 1 yard, 18 sq. ft.</i> <i>Base 4-star die cast aluminum with black glides</i> <i>Cushion high density HR foam</i>					

Specify

Upholstery (not available in Bristol leather 5-597 Pure)
 Base Finish
 Fire Retardancy (specify NOCAL)

Note: Saiba lounge ottoman requires an additional 1 yard of fabric / 18 sq. ft. of leather for testing for all COM/COL orders, plus the standard memo-sized sample.

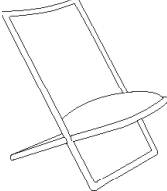
	Product Number	Depth	Width	Height	Basic Price	Upholstery
Scissor wood or metal frame 	<i>ash frame</i> SBSC-1098	30	24	33	\$2,710	<i>Basic/COM Price does not include fabric. Refer to the upholstery upcharge pages for fabric and COL pricing. 1 yard = 18 sq. ft.</i>
	<i>metal frame</i> SBSD-1099	29	24	33	\$3,025	
<i>COM/COL..... 3 1/2 yards, 63 sq. ft.</i> <i>Seat height 15 1/2"</i> <i>Frame solid ash or welded tubular steel</i> <i>Seat foam and Dacron over plywood</i> <i>Back HR foam over hardwood insert</i>						



Specify

Upholstery
Wood (Not required on Scissor chair with metal frame)
Base (Not required on Scissor chair with wood frame)
Fire Retardancy (specify NOCAL)

	Product Number	Depth	Width	Height	Basic Price	Upholstery
Sled metal frame 	SBSU-1060	30 1/2	28 1/2	31	\$4,535	<i>Basic/COM Price does not include fabric. Refer to the upholstery upcharge pages for fabric and COL pricing. 1 yard = 18 sq. ft.</i>
	COM/COL..... 3 yards, 54 sq. ft. Seat height 17" Frame welded tubular steel Seat foam and Dacron over plywood Back HR foam over hardwood insert					

Specify

Upholstery
 Base Finish
 Fire Retardancy (specify NOCAL)

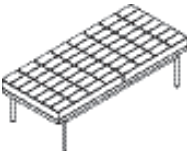
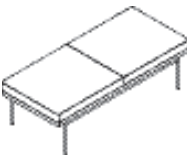
	Product Number	Depth	Width	Height	Basic Price	Upholstery
Tuxedo • Ottoman <i>quilted</i> 	ST1BQ	28	28	17	\$1,360	<i>Basic/COM Price does not include fabric. Refer to the upholstery upcharge pages for fabric and COL pricing. 1 yard = 18 sq. ft.</i>
	<i>COM/COL..... 1 1/2 yards, 27 sq. ft.</i> <i>Seat height 17"</i> <i>Seat..... foam and Dacron</i> <i>Base painted or plated steel</i>					
Tuxedo • Ottoman <i>non-quilted</i> 	ST1BN	28	28	17	\$1,320	<i>Basic/COM Price does not include fabric. Refer to the upholstery upcharge pages for fabric and COL pricing. 1 yard = 18 sq. ft.</i>
	<i>COM/COL..... 1 1/2 yards, 27 sq. ft.</i> <i>Seat height 17"</i> <i>Seat..... foam and Dacron</i> <i>Base painted or plated steel</i>					
Tuxedo • Bench <i>quilted</i> 	ST2BQ	28	56	17	\$2,240	<i>Basic/COM Price does not include fabric. Refer to the upholstery upcharge pages for fabric and COL pricing. 1 yard = 18 sq. ft.</i>
	<i>specify ganging plates (STGP) separately</i> <i>COM/COL..... 3 yards, 54 sq. ft.</i> <i>Seat height 17"</i> <i>Seat..... foam and Dacron</i> <i>Base painted or plated steel</i>					
Tuxedo • Bench <i>non-quilted</i> 	ST2BN	28	56	17	\$2,170	<i>Basic/COM Price does not include fabric. Refer to the upholstery upcharge pages for fabric and COL pricing. 1 yard = 18 sq. ft.</i>
	<i>specify ganging plates (STGP) separately</i> <i>COM/COL..... 3 yards, 54 sq. ft.</i> <i>Seat height 17"</i> <i>Seat..... foam and Dacron</i> <i>Base painted or plated steel</i>					

Specify

Upholstery
 Base Finish
 Fire Retardancy (specify NOCAL)

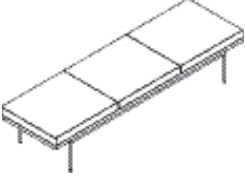
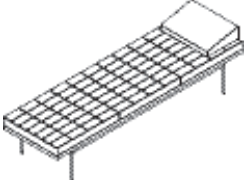
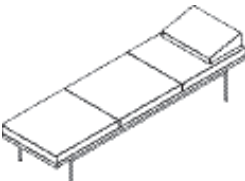

Note: Tuxedo Component Ottomans cannot be ganged to other seating.

	Product Number	Depth	Width	Height	Basic Price	Upholstery
Tuxedo • Bench <i>quilted</i> 	ST3BQ specify ganging plates (STGP) separately COM/COL..... 5 1/2 yards, 99 sq. ft. Seat height 17" Seat foam and Dacron Base painted or plated steel	28	84	17	\$3,040	Basic/COM Price does not include fabric. Refer to the upholstery upcharge pages for fabric and COL pricing. 1 yard = 18 sq. ft.
Tuxedo • Bench <i>non-quilted</i> 	ST3BN specify ganging plates (STGP) separately COM/COL..... 5 1/2 yards, 99 sq. ft. Seat height 17" Seat foam and Dacron Base painted or plated steel	28	84	17	\$2,975	Basic/COM Price does not include fabric. Refer to the upholstery upcharge pages for fabric and COL pricing. 1 yard = 18 sq. ft.
Tuxedo • Daybed <i>quilted</i> 	ST3DQ COM/COL..... 6 1/2 yards, 117 sq. ft. Seat height 17" Seat foam and Dacron Base painted or plated steel	28	84	22 1/4	\$3,390	Basic/COM Price does not include fabric. Refer to the upholstery upcharge pages for fabric and COL pricing. 1 yard = 18 sq. ft.
Tuxedo • Daybed <i>non-quilted</i> 	ST3DN COM/COL..... 6 1/2 yards, 117 sq. ft. Seat height 17" Seat foam and Dacron Base painted or plated steel	28	84	22 1/4	\$3,325	Basic/COM Price does not include fabric. Refer to the upholstery upcharge pages for fabric and COL pricing. 1 yard = 18 sq. ft.

Specify

Upholstery
 Base Finish
 Fire Retardancy (specify NOCAL)

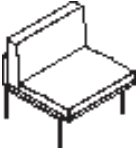

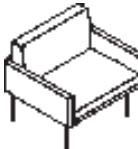
Note: Tuxedo Component Daybeds cannot be ganged to other seating.

	Product Number	Depth	Width	Height	Basic Price	Upholstery
Tuxedo • Club Chair armless, quilted 	ST1NQ	28	28	30	\$2,520	<i>Basic/COM Price does not include fabric. Refer to the upholstery upcharge pages for fabric and COL pricing. 1 yard = 18 sq. ft.</i>
	COM/COL..... 3 3/4 yards, 67 1/2 sq. ft. Seat height 17" Seat foam and Dacron Base painted or plated steel					
Tuxedo • Club Chair armless, non-quilted 	ST1NN	28	28	30	\$2,340	<i>Basic/COM Price does not include fabric. Refer to the upholstery upcharge pages for fabric and COL pricing. 1 yard = 18 sq. ft.</i>
	COM/COL..... 3 3/4 yards, 67 1/2 sq. ft. Seat height 17" Seat foam and Dacron Base painted or plated steel					
Tuxedo • Club Chair with arms, quilted 	ST1AQ	28	32	30	\$3,080	<i>Basic/COM Price does not include fabric. Refer to the upholstery upcharge pages for fabric and COL pricing. 1 yard = 18 sq. ft.</i>
	COM/COL..... 5 1/2 yards, 99 sq. ft. Seat height 17" Arm height 23 1/2" Seat foam and Dacron Base painted or plated steel					
Tuxedo • Club Chair with arms, non-quilted 	ST1AN	28	32	30	\$2,970	<i>Basic/COM Price does not include fabric. Refer to the upholstery upcharge pages for fabric and COL pricing. 1 yard = 18 sq. ft.</i>
	COM/COL..... 5 1/2 yards, 99 sq. ft. Seat height 17" Arm height 23 1/2" Seat foam and Dacron Base painted or plated steel					

Specify

Upholstery
 Base Finish
 Fire Retardancy (specify NOCAL)

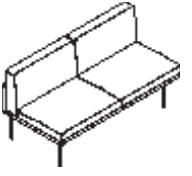

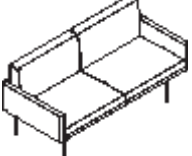
Note: Tuxedo Component Club Chairs cannot be ganged to other seating.

	Product Number	Depth	Width	Height	Basic Price	Upholstery
Tuxedo • Settee armless, quilted 	ST2NQ specify ganging plates (STGP) separately COM/COL..... 7 1/2 yards, 135 sq. ft. Seat height 17" Arm height 23 1/2" Seat foam and Dacron Base painted or plated steel	28	56	30	\$3,980	Basic/COM Price does not include fabric. Refer to the upholstery upcharge pages for fabric and COL pricing. 1 yard = 18 sq. ft.
Tuxedo • Settee armless, non-quilted 	ST2NN specify ganging plates (STGP) separately COM/COL..... 7 1/2 yards, 135 sq. ft. Seat height 17" Arm height 23 1/2" Seat foam and Dacron Base painted or plated steel	28	56	30	\$3,870	Basic/COM Price does not include fabric. Refer to the upholstery upcharge pages for fabric and COL pricing. 1 yard = 18 sq. ft.
Tuxedo • Settee with arms, quilted 	ST2AQ COM/COL..... 9 1/4 yards, 166 1/2 sq. ft. Seat height 17" Arm height 23 1/2" Seat foam and Dacron Base painted or plated steel	28	60	30	\$4,705	Basic/COM Price does not include fabric. Refer to the upholstery upcharge pages for fabric and COL pricing. 1 yard = 18 sq. ft.
Tuxedo • Settee with arms, non-quilted 	ST2AN COM/COL..... 9 1/4 yards, 166 1/2 sq. ft. Seat height 17" Arm height 23 1/2" Seat foam and Dacron Base painted or plated steel	28	60	30	\$4,405	Basic/COM Price does not include fabric. Refer to the upholstery upcharge pages for fabric and COL pricing. 1 yard = 18 sq. ft.

Specify

Upholstery
 Base Finish
 Fire Retardancy (specify NOCAL)

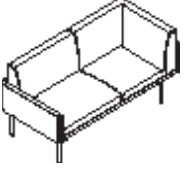

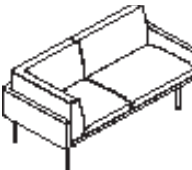
Note: Tuxedo Component Settees ST2AN and ST2AQ cannot be ganged to other seating.

	Product Number	Depth	Width	Height	Basic Price	Upholstery
Tuxedo • Settee corner left, arm right, quilted 	ST2CLAQ includes one set of two ganging plates COM/COL..... 10 1/4 yards, 184 1/2 sq. ft. Seat height 17" Arm height 23 1/2" Seat foam and Dacron Base painted or plated steel	28	58	30	\$5,080	Basic/COM Price does not include fabric. Refer to the upholstery upcharge pages for fabric and COL pricing. 1 yard = 18 sq. ft.
Tuxedo • Settee corner left, arm right, non-quilted 	ST2CLAN includes one set of two ganging plates COM/COL..... 10 1/4 yards, 184 1/2 sq. ft. Seat height 17" Arm height 23 1/2" Seat foam and Dacron Base painted or plated steel	28	58	30	\$4,870	Basic/COM Price does not include fabric. Refer to the upholstery upcharge pages for fabric and COL pricing. 1 yard = 18 sq. ft.
Tuxedo • Settee corner right, arm left, quilted 	ST2CRAQ includes one set of two ganging plates COM/COL..... 10 1/4 yards, 184 1/2 sq. ft. Seat height 17" Arm height 23 1/2" Seat foam and Dacron Base painted or plated steel	28	58	30	\$5,080	Basic/COM Price does not include fabric. Refer to the upholstery upcharge pages for fabric and COL pricing. 1 yard = 18 sq. ft.
Tuxedo • Settee corner right, arm left, non-quilted 	ST2CRAN includes one set of two ganging plates COM/COL..... 10 1/4 yards, 184 1/2 sq. ft. Seat height 17" Arm height 23 1/2" Seat foam and Dacron Base painted or plated steel	28	58	30	\$4,870	Basic/COM Price does not include fabric. Refer to the upholstery upcharge pages for fabric and COL pricing. 1 yard = 18 sq. ft.

Specify

Upholstery
 Base Finish
 Fire Retardancy (specify NOCAL)

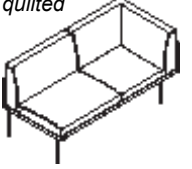

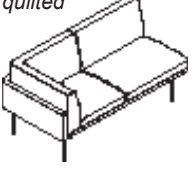
See Geiger occasional tables pricebook for Tuxedo component occasional tables.

	Product Number	Depth	Width	Height	Basic Price	Upholstery
<p>Tuxedo • Settee corner left, armless right, quilted</p> 	<p>ST2CLNQ includes one set of two ganging plates</p> <p>COM/COL..... 9 1/4 yards, 166 1/2 sq. ft. Seat height 17" Arm height 23 1/2" Seat foam and Dacron Base painted or plated steel</p>	28	56	30	\$4,750	Basic/COM Price does not include fabric. Refer to the upholstery upcharge pages for fabric and COL pricing. 1 yard = 18 sq. ft.
<p>Tuxedo • Settee corner left, armless right, non-quilted</p> 	<p>ST2CLNN includes one set of two ganging plates</p> <p>COM/COL..... 9 1/4 yards, 166 1/2 sq. ft. Seat height 17" Arm height 23 1/2" Seat foam and Dacron Base painted or plated steel</p>	28	56	30	\$4,665	Basic/COM Price does not include fabric. Refer to the upholstery upcharge pages for fabric and COL pricing. 1 yard = 18 sq. ft.
<p>Tuxedo • Settee corner right, armless left, quilted</p> 	<p>ST2CRNQ includes one set of two ganging plates</p> <p>COM/COL..... 9 1/4 yards, 166 1/2 sq. ft. Seat height 17" Arm height 23 1/2" Seat foam and Dacron Base painted or plated steel</p>	28	56	30	\$4,750	Basic/COM Price does not include fabric. Refer to the upholstery upcharge pages for fabric and COL pricing. 1 yard = 18 sq. ft.
<p>Tuxedo • Settee corner right, armless left, non-quilted</p> 	<p>ST2CRNN includes one set of two ganging plates</p> <p>COM/COL..... 9 1/4 yards, 166 1/2 sq. ft. Seat height 17" Arm height 23 1/2" Seat foam and Dacron Base painted or plated steel</p>	28	56	30	\$4,665	Basic/COM Price does not include fabric. Refer to the upholstery upcharge pages for fabric and COL pricing. 1 yard = 18 sq. ft.

Specify

Upholstery
Base Finish
Fire Retardancy (specify NOCAL)

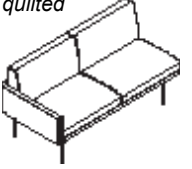
See Geiger occasional tables pricebook for Tuxedo component occasional tables.

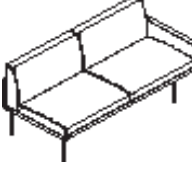
	Product Number	Depth	Width	Height	Basic Price	Upholstery
<p>Tuxedo • Settee arm right, armless left, quilted</p> 	<p>ST2ARQ specify ganging plates (STGP) separately</p> <p>COM/COL..... 8 1/2 yards, 153 sq. ft. Seat height 17" Arm height 23 1/2" Seat foam and Dacron Base painted or plated steel</p>	28	58	30	\$4,160	Basic/COM Price does not include fabric. Refer to the upholstery upcharge pages for fabric and COL pricing. 1 yard = 18 sq. ft.
<p>Tuxedo • Settee arm right, armless left, non-quilted</p> 	<p>ST2ARN specify ganging plates (STGP) separately</p> <p>COM/COL..... 8 1/2 yards, 153 sq. ft. Seat height 17" Arm height 23 1/2" Seat foam and Dacron Base painted or plated steel</p>	28	58	30	\$4,025	Basic/COM Price does not include fabric. Refer to the upholstery upcharge pages for fabric and COL pricing. 1 yard = 18 sq. ft.
<p>Tuxedo • Settee arm left, armless right, quilted</p> 	<p>ST2ALQ specify ganging plates (STGP) separately</p> <p>COM/COL..... 8 1/2 yards, 153 sq. ft. Seat height 17" Arm height 23 1/2" Seat foam and Dacron Base painted or plated steel</p>	28	58	30	\$4,160	Basic/COM Price does not include fabric. Refer to the upholstery upcharge pages for fabric and COL pricing. 1 yard = 18 sq. ft.
<p>Tuxedo • Settee arm left, armless right, non-quilted</p> 	<p>ST2ALN specify ganging plates (STGP) separately</p> <p>COM/COL..... 8 1/2 yards, 153 sq. ft. Seat height 17" Arm height 23 1/2" Seat foam and Dacron Base painted or plated steel</p>	28	58	30	\$4,025	Basic/COM Price does not include fabric. Refer to the upholstery upcharge pages for fabric and COL pricing. 1 yard = 18 sq. ft.

Specify

Upholstery
Base Finish
Fire Retardancy (specify NOCAL)

See Geiger occasional tables pricebook for Tuxedo component occasional tables.

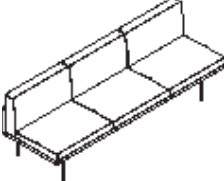
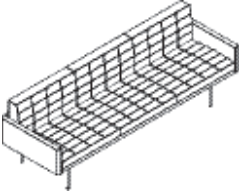
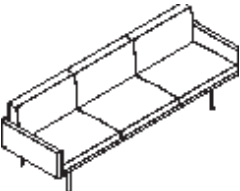

	Product Number	Depth	Width	Height	Basic Price	Upholstery
<p>Tuxedo • Sofa armless, quilted</p> 	<p>ST3NQ specify ganging plates (STGP) separately</p> <p>COM/COL..... 11 1/4 yards, 202 1/2 sq. ft. Seat height 17" Seat foam and Dacron Base painted or plated steel</p>	28	84	30	\$5,535	Basic/COM Price does not include fabric. Refer to the upholstery upcharge pages for fabric and COL pricing. 1 yard = 18 sq. ft.
<p>Tuxedo • Sofa armless, non-quilted</p> 	<p>ST3NN specify ganging plates (STGP) separately</p> <p>COM/COL..... 11 1/4 yards, 202 1/2 sq. ft. Seat height 17" Seat foam and Dacron Base painted or plated steel</p>	28	84	30	\$5,355	Basic/COM Price does not include fabric. Refer to the upholstery upcharge pages for fabric and COL pricing. 1 yard = 18 sq. ft.
<p>Tuxedo • Sofa with arms, quilted</p> 	<p>ST3AQ</p> <p>COM/COL..... 13 yards, 234 sq. ft. Seat height 17" Arm height 23 1/2" Seat foam and Dacron Base painted or plated steel</p>	28	88	30	\$6,200	Basic/COM Price does not include fabric. Refer to the upholstery upcharge pages for fabric and COL pricing. 1 yard = 18 sq. ft.
<p>Tuxedo • Sofa with arms, non-quilted</p> 	<p>ST3AN</p> <p>COM/COL..... 13 yards, 234 sq. ft. Seat height 17" Arm height 23 1/2" Seat foam and Dacron Base painted or plated steel</p>	28	88	30	\$6,020	Basic/COM Price does not include fabric. Refer to the upholstery upcharge pages for fabric and COL pricing. 1 yard = 18 sq. ft.

Specify

Upholstery
Base Finish
Fire Retardancy (specify NOCAL)

See Geiger occasional tables pricebook for Tuxedo component occasional tables.

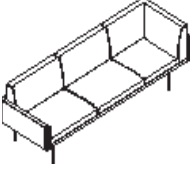

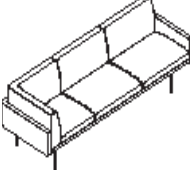
Note: Tuxedo Component Sofas ST3AN and ST3AQ cannot be ganged to other seating.

	Product Number	Depth	Width	Height	Basic Price	Upholstery
Tuxedo • Sofa corner left, arm right, quilted 	ST3CLAQ includes one set of two ganging plates COM/COL..... 14 yards, 252 sq. ft. Seat height 17" Arm height 23 1/2" Seat foam and Dacron Base painted or plated steel	28	86	30	\$6,585	Basic/COM Price does not include fabric. Refer to the upholstery upcharge pages for fabric and COL pricing. 1 yard = 18 sq. ft.
Tuxedo • Sofa corner left, arm right, non-quilted 	ST3CLAN includes one set of two ganging plates COM/COL..... 14 yards, 252 sq. ft. Seat height 17" Arm height 23 1/2" Seat foam and Dacron Base painted or plated steel	28	86	30	\$6,405	Basic/COM Price does not include fabric. Refer to the upholstery upcharge pages for fabric and COL pricing. 1 yard = 18 sq. ft.
Tuxedo • Sofa corner right, arm left, quilted 	ST3CRAQ includes one set of two ganging plates COM/COL..... 14 yards, 252 sq. ft. Seat height 17" Arm height 23 1/2" Seat foam and Dacron Base painted or plated steel	28	86	30	\$6,585	Basic/COM Price does not include fabric. Refer to the upholstery upcharge pages for fabric and COL pricing. 1 yard = 18 sq. ft.
Tuxedo • Sofa corner right, arm left, non-quilted 	ST3CRAN includes one set of two ganging plates COM/COL..... 14 yards, 252 sq. ft. Seat height 17" Arm height 23 1/2" Seat foam and Dacron Base painted or plated steel	28	86	30	\$6,405	Basic/COM Price does not include fabric. Refer to the upholstery upcharge pages for fabric and COL pricing. 1 yard = 18 sq. ft.

Specify

Upholstery
 Base Finish
 Fire Retardancy (specify NOCAL)

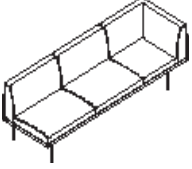

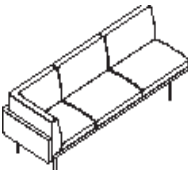
See Geiger occasional tables pricebook for Tuxedo component occasional tables.

	Product Number	Depth	Width	Height	Basic Price	Upholstery
Tuxedo • Sofa corner left, armless right, quilted 	ST3CLNQ includes one set of two ganging plates COM/COL..... 13 yards, 234 sq. ft. Seat height 17" Arm height 23 1/2" Seat foam and Dacron Base painted or plated steel	28	84	30	\$6,260	Basic/COM Price does not include fabric. Refer to the upholstery upcharge pages for fabric and COL pricing. 1 yard = 18 sq. ft.
Tuxedo • Sofa corner left, armless right, non-quilted 	ST3CLNN includes one set of two ganging plates COM/COL..... 13 yards, 234 sq. ft. Seat height 17" Arm height 23 1/2" Seat foam and Dacron Base painted or plated steel	28	84	30	\$6,180	Basic/COM Price does not include fabric. Refer to the upholstery upcharge pages for fabric and COL pricing. 1 yard = 18 sq. ft.
Tuxedo • Sofa corner right, armless left, quilted 	ST3CRNQ includes one set of two ganging plates COM/COL..... 13 yards, 234 sq. ft. Seat height 17" Arm height 23 1/2" Seat foam and Dacron Base painted or plated steel	28	84	30	\$6,260	Basic/COM Price does not include fabric. Refer to the upholstery upcharge pages for fabric and COL pricing. 1 yard = 18 sq. ft.
Tuxedo • Sofa corner right, armless left, non-quilted 	ST3CRNN includes one set of two ganging plates COM/COL..... 13 yards, 234 sq. ft. Seat height 17" Arm height 23 1/2" Seat foam and Dacron Base painted or plated steel	28	84	30	\$6,180	Basic/COM Price does not include fabric. Refer to the upholstery upcharge pages for fabric and COL pricing. 1 yard = 18 sq. ft.

Specify

Upholstery
 Base Finish
 Fire Retardancy (specify NOCAL)

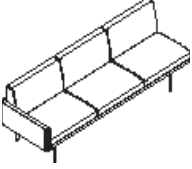
See Geiger occasional tables pricebook for Tuxedo component occasional tables.

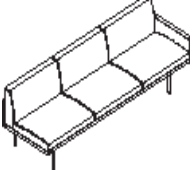
	Product Number	Depth	Width	Height	Basic Price	Upholstery
<p>Tuxedo • Sofa arm right, armless left, quilted</p> 	<p>ST3ARQ specify ganging plates (STGP) separately</p> <p>COM/COL..... 12 1/4 yards, 220 1/2 sq. ft. Seat height 17" Arm height 23 1/2" Seat foam and Dacron Base painted or plated steel</p>	28	86	30	\$5,785	Basic/COM Price does not include fabric. Refer to the upholstery upcharge pages for fabric and COL pricing. 1 yard = 18 sq. ft.
<p>Tuxedo • Sofa arm right, armless left, non-quilted</p> 	<p>ST3ARN specify ganging plates (STGP) separately</p> <p>COM/COL..... 12 1/4 yards, 220 1/2 sq. ft. Seat height 17" Arm height 23 1/2" Seat foam and Dacron Base painted or plated steel</p>	28	86	30	\$5,605	Basic/COM Price does not include fabric. Refer to the upholstery upcharge pages for fabric and COL pricing. 1 yard = 18 sq. ft.
<p>Tuxedo • Sofa arm left, armless right, quilted</p> 	<p>ST3ALQ specify ganging plates (STGP) separately</p> <p>COM/COL..... 12 1/4 yards, 220 1/2 sq. ft. Seat height 17" Arm height 23 1/2" Seat foam and Dacron Base painted or plated steel</p>	28	86	30	\$5,785	Basic/COM Price does not include fabric. Refer to the upholstery upcharge pages for fabric and COL pricing. 1 yard = 18 sq. ft.
<p>Tuxedo • Sofa arm left, armless right, non-quilted</p> 	<p>ST3ALN specify ganging plates (STGP) separately</p> <p>COM/COL..... 12 1/4 yards, 220 1/2 sq. ft. Seat height 17" Arm height 23 1/2" Seat foam and Dacron Base painted or plated steel</p>	28	86	30	\$5,605	Basic/COM Price does not include fabric. Refer to the upholstery upcharge pages for fabric and COL pricing. 1 yard = 18 sq. ft.

Specify

Upholstery
Base Finish
Fire Retardancy (specify NOCAL)

See Geiger occasional tables pricebook for Tuxedo component occasional tables.

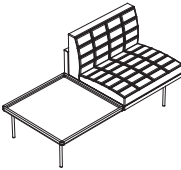
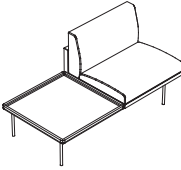
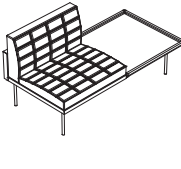
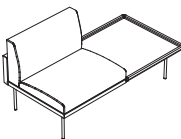
	Product Number	Depth	Width	Height	Basic Price	Upholstery
<p>Tuxedo • Club Chair with Table armless, seat left, table right, quilted</p> 	<p>SX1NLQ specify ganging plates (STGP) separately</p> <p>COM/COL..... 3 3/4 yards, 67 1/2 sq. ft. Seat height 17" Seat HR foam, Dacron, and polyfoam cushions Base painted or plated steel</p>	28	56	30	\$3,620	Basic/COM Price does not include fabric. Refer to the upholstery upcharge pages for fabric and COL pricing. 1 yard = 18 sq. ft.
<p>Tuxedo • Club Chair with Table armless, seat left, table right, non-quilted</p> 	<p>SX1NLN specify ganging plates (STGP) separately</p> <p>COM/COL..... 3 3/4 yards, 67 1/2 sq. ft. Seat height 17" Seat HR foam, Dacron, and polyfoam cushions Base painted or plated steel</p>	28	56	30	\$3,485	Basic/COM Price does not include fabric. Refer to the upholstery upcharge pages for fabric and COL pricing. 1 yard = 18 sq. ft.
<p>Tuxedo • Club Chair with Table armless, seat right, table left, quilted</p> 	<p>SX1NRQ specify ganging plates (STGP) separately</p> <p>COM/COL..... 3 3/4 yards, 67 1/2 sq. ft. Seat height 17" Seat HR foam, Dacron, and polyfoam cushions Base painted or plated steel</p>	28	56	30	\$3,620	Basic/COM Price does not include fabric. Refer to the upholstery upcharge pages for fabric and COL pricing. 1 yard = 18 sq. ft.
<p>Tuxedo • Club Chair with Table armless, seat right, table left, non-quilted</p> 	<p>SX1NRN specify ganging plates (STGP) separately</p> <p>COM/COL..... 3 3/4 yards, 67 1/2 sq. ft. Seat height 17" Seat HR foam, Dacron, and polyfoam cushions Base painted or plated steel</p>	28	56	30	\$3,485	Basic/COM Price does not include fabric. Refer to the upholstery upcharge pages for fabric and COL pricing. 1 yard = 18 sq. ft.

Specify

Wood
Upholstery
Base Finish
Fire Retardancy (specify NOCAL)

See Geiger occasional tables pricebook for Tuxedo component occasional tables.

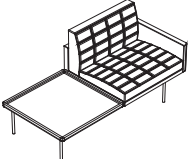
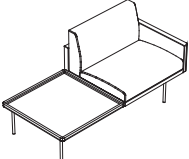
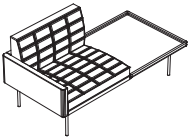
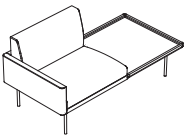
	Product Number	Depth	Width	Height	Basic Price	Upholstery
<p>Tuxedo • Club Chair with Table arm left, table right, quilted</p> 	<p>SX1ALQ specify ganging plates (STGP) separately</p> <p>COM/COL..... 4 3/4 yards, 85 1/2 sq. ft. Seat height 17" Arm height 23 1/2" Seat HR foam, Dacron, and polyfoam cushions Base painted or plated steel</p>	28	58	30	\$3,955	Basic/COM Price does not include fabric. Refer to the upholstery upcharge pages for fabric and COL pricing. 1 yard = 18 sq. ft.
<p>Tuxedo • Club Chair with Table arm left, table right, non-quilted</p> 	<p>SX1ALN specify ganging plates (STGP) separately</p> <p>COM/COL..... 4 3/4 yards, 85 1/2 sq. ft. Seat height 17" Arm height 23 1/2" Seat HR foam, Dacron, and polyfoam cushions Base painted or plated steel</p>	28	58	30	\$3,820	Basic/COM Price does not include fabric. Refer to the upholstery upcharge pages for fabric and COL pricing. 1 yard = 18 sq. ft.
<p>Tuxedo • Club Chair with Table arm right, table left, quilted</p> 	<p>SX1ARQ specify ganging plates (STGP) separately</p> <p>COM/COL..... 4 3/4 yards, 85 1/2 sq. ft. Seat height 17" Arm height 23 1/2" Seat HR foam, Dacron, and polyfoam cushions Base painted or plated steel</p>	28	58	30	\$3,955	Basic/COM Price does not include fabric. Refer to the upholstery upcharge pages for fabric and COL pricing. 1 yard = 18 sq. ft.
<p>Tuxedo • Club Chair with Table arm right, table left, non-quilted</p> 	<p>SX1ARN specify ganging plates (STGP) separately</p> <p>COM/COL..... 4 3/4 yards, 85 1/2 sq. ft. Seat height 17" Arm height 23 1/2" Seat HR foam, Dacron, and polyfoam cushions Base painted or plated steel</p>	28	58	30	\$3,820	Basic/COM Price does not include fabric. Refer to the upholstery upcharge pages for fabric and COL pricing. 1 yard = 18 sq. ft.

Specify

Wood
Upholstery
Base Finish
Fire Retardancy (specify NOCAL)

See Geiger occasional tables pricebook for Tuxedo component occasional tables.

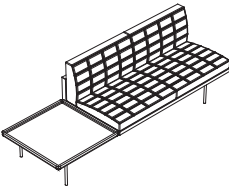
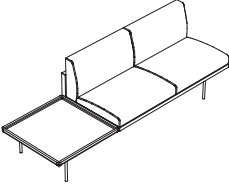
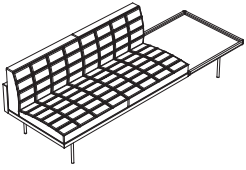
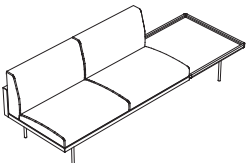
	Product Number	Depth	Width	Height	Basic Price	Upholstery
<p>Tuxedo • Settee with Table armless, seat left, table right, quilted</p> 	<p>SX2NLQ specify ganging plates (STGP) separately</p> <p>COM/COL..... 7 1/2 yards, 135 sq. ft. Seat height 17" Seat HR foam, Dacron, and polyfoam cushions Base painted or plated steel</p>	28	84	30	\$4,920	Basic/COM Price does not include fabric. Refer to the upholstery upcharge pages for fabric and COL pricing. 1 yard = 18 sq. ft.
<p>Tuxedo • Settee with Table armless, seat left, table right, non-quilted</p> 	<p>SX2NLN specify ganging plates (STGP) separately</p> <p>COM/COL..... 7 1/2 yards, 135 sq. ft. Seat height 17" Seat HR foam, Dacron, and polyfoam cushions Base painted or plated steel</p>	28	84	30	\$4,640	Basic/COM Price does not include fabric. Refer to the upholstery upcharge pages for fabric and COL pricing. 1 yard = 18 sq. ft.
<p>Tuxedo • Settee with Table armless, seat right, table left, quilted</p> 	<p>SX2NRQ specify ganging plates (STGP) separately</p> <p>COM/COL..... 7 1/2 yards, 135 sq. ft. Seat height 17" Seat HR foam, Dacron, and polyfoam cushions Base painted or plated steel</p>	28	84	30	\$4,920	Basic/COM Price does not include fabric. Refer to the upholstery upcharge pages for fabric and COL pricing. 1 yard = 18 sq. ft.
<p>Tuxedo • Settee with Table armless, seat right, table left, non-quilted</p> 	<p>SX2NRN specify ganging plates (STGP) separately</p> <p>COM/COL..... 7 1/2 yards, 135 sq. ft. Seat height 17" Seat HR foam, Dacron, and polyfoam cushions Base painted or plated steel</p>	28	84	30	\$4,640	Basic/COM Price does not include fabric. Refer to the upholstery upcharge pages for fabric and COL pricing. 1 yard = 18 sq. ft.

Specify

Wood
Upholstery
Base Finish
Fire Retardancy (specify NOCAL)

See Geiger occasional tables pricebook for Tuxedo component occasional tables.

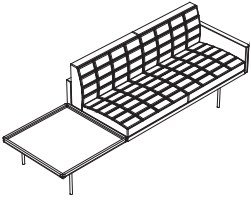
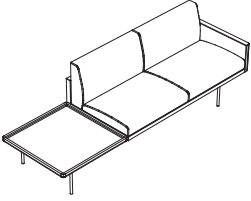
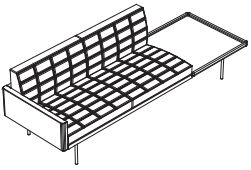
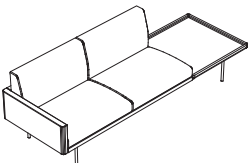
	Product Number	Depth	Width	Height	Basic Price	Upholstery
<p>Tuxedo • Settee with Table arm left, table right, quilted</p> 	<p>SX2ALQ specify ganging plates (STGP) separately</p> <p>COM/COL..... 8 1/2 yards, 153 sq. ft. Seat height 17" Arm height 23 1/2" Seat HR foam, Dacron, and polyfoam cushions Base painted or plated steel</p>	28	86	30	\$5,255	Basic/COM Price does not include fabric. Refer to the upholstery upcharge pages for fabric and COL pricing. 1 yard = 18 sq. ft.
<p>Tuxedo • Settee with Table arm left, table right, non-quilted</p> 	<p>SX2ALN specify ganging plates (STGP) separately</p> <p>COM/COL..... 8 1/2 yards, 153 sq. ft. Seat height 17" Arm height 23 1/2" Seat HR foam, Dacron, and polyfoam cushions Base painted or plated steel</p>	28	86	30	\$4,975	Basic/COM Price does not include fabric. Refer to the upholstery upcharge pages for fabric and COL pricing. 1 yard = 18 sq. ft.
<p>Tuxedo • Settee with Table arm right, table left, quilted</p> 	<p>SX2ARQ specify ganging plates (STGP) separately</p> <p>COM/COL..... 8 1/2 yards, 153 sq. ft. Seat height 17" Arm height 23 1/2" Seat HR foam, Dacron, and polyfoam cushions Base painted or plated steel</p>	28	86	30	\$5,255	Basic/COM Price does not include fabric. Refer to the upholstery upcharge pages for fabric and COL pricing. 1 yard = 18 sq. ft.
<p>Tuxedo • Settee with Table arm right, table left, quilted</p> 	<p>SX2ARN specify ganging plates (STGP) separately</p> <p>COM/COL..... 8 1/2 yards, 153 sq. ft. Seat height 17" Arm height 23 1/2" Seat HR foam, Dacron, and polyfoam cushions Base painted or plated steel</p>	28	86	30	\$4,975	Basic/COM Price does not include fabric. Refer to the upholstery upcharge pages for fabric and COL pricing. 1 yard = 18 sq. ft.

Specify

Wood
Upholstery
Base Finish
Fire Retardancy (specify NOCAL)

See Geiger occasional tables pricebook for Tuxedo component occasional tables.

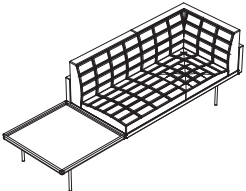
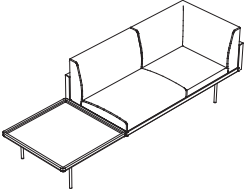
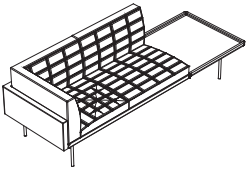
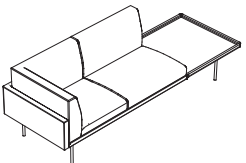
	Product Number	Depth	Width	Height	Basic Price	Upholstery
<p>Tuxedo • Settee with Table corner left, table right, quilted</p> 	<p>SX2CLQ specify ganging plates (STGP) separately</p> <p>COM/COL..... 9 1/4 yards, 166.5 sq. ft. Seat height 17" Arm height 30" Seat HR foam, Dacron, and polyfoam cushions Base painted or plated steel</p>	28	86	30	\$5,900	Basic/COM Price does not include fabric. Refer to the upholstery upcharge pages for fabric and COL pricing. 1 yard = 18 sq. ft.
<p>Tuxedo • Settee with Table corner left, table right, non-quilted</p> 	<p>SX2CLN specify ganging plates (STGP) separately</p> <p>COM/COL..... 9 1/4 yards, 166.5 sq. ft. Seat height 17" Arm height 30" Seat HR foam, Dacron, and polyfoam cushions Base painted or plated steel</p>	28	86	30	\$5,570	Basic/COM Price does not include fabric. Refer to the upholstery upcharge pages for fabric and COL pricing. 1 yard = 18 sq. ft.
<p>Tuxedo • Settee with Table corner right, table left, quilted</p> 	<p>SX2CRQ specify ganging plates (STGP) separately</p> <p>COM/COL..... 9 1/4 yards, 166.5 sq. ft. Seat height 17" Arm height 30" Seat HR foam, Dacron, and polyfoam cushions Base painted or plated steel</p>	28	86	30	\$5,900	Basic/COM Price does not include fabric. Refer to the upholstery upcharge pages for fabric and COL pricing. 1 yard = 18 sq. ft.
<p>Tuxedo • Settee with Table corner right, table left, non-quilted</p> 	<p>SX2CRN specify ganging plates (STGP) separately</p> <p>COM/COL..... 9 1/4 yards, 166.5 sq. ft. Seat height 17" Arm height 30" Seat HR foam, Dacron, and polyfoam cushions Base painted or plated steel</p>	28	86	30	\$5,570	Basic/COM Price does not include fabric. Refer to the upholstery upcharge pages for fabric and COL pricing. 1 yard = 18 sq. ft.

Specify

Wood
Upholstery
Base Finish
Fire Retardancy (specify NOCAL)

See Geiger occasional tables pricebook for Tuxedo component occasional tables.

	Product Number	Depth	Width	Height	Basic Price
Tuxedo • Ganging Plates	STGP	3	5 1/4	3/16	\$77

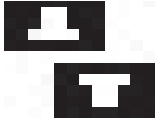

includes two plates and associated screws

Specify

no options

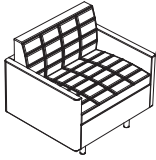
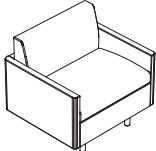
	Product Number	Depth	Width	Height	Basic Price	Upholstery
Tuxedo Classic • Club Chair <i>quilted</i> 	SZ1ABQ	28	32	30	\$2,790	<i>Basic/COM Price does not include fabric. Refer to the upholstery upcharge pages for fabric and COL pricing. 1 yard = 18 sq. ft.</i>
	COM/COL..... 6 1/2 yards, 117 sq. ft. Seat height 17 3/4" Arm height 23" Seat HR foam, Dacron, and polyfoam cushions Base solid ash or walnut					
Tuxedo Classic • Club Chair <i>non-quilted</i> 	SZ1ABN	28	32	30	\$2,650	<i>Basic/COM Price does not include fabric. Refer to the upholstery upcharge pages for fabric and COL pricing. 1 yard = 18 sq. ft.</i>
	COM/COL..... 6 1/2 yards, 117 sq. ft. Seat height 17 3/4" Arm height 23" Seat HR foam, Dacron, and polyfoam cushions Base solid ash or walnut					

Specify

Upholstery

Base

Fire Retardancy (specify NOCAL)

See Geiger occasional tables pricebook for Tuxedo component occasional tables.

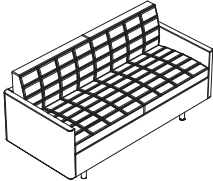
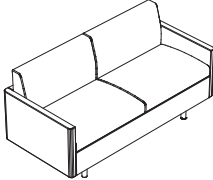
	Product Number	Depth	Width	Height	Basic Price	Upholstery
Tuxedo Classic • Settee <i>quilted</i> 	SZ2ABQ	28	60	30	\$4,485	<i>Basic/COM Price does not include fabric. Refer to the upholstery upcharge pages for fabric and COL pricing. 1 yard = 18 sq. ft.</i> COM/COL..... 10 1/2 yards, 189 sq. ft. Seat height 17 3/4" Arm height 23" Seat HR foam, Dacron, and polyfoam cushions Base solid ash or walnut
Tuxedo Classic • Settee <i>non-quilted</i> 	SZ2ABN	28	60	30	\$4,210	<i>Basic/COM Price does not include fabric. Refer to the upholstery upcharge pages for fabric and COL pricing. 1 yard = 18 sq. ft.</i> COM/COL..... 10 1/2 yards, 189 sq. ft. Seat height 17 3/4" Arm height 23" Seat HR foam, Dacron, and polyfoam cushions Base solid ash or walnut

Specify

Upholstery
 Base
 Fire Retardancy (specify NOCAL)

See Geiger occasional tables pricebook for Tuxedo component occasional tables.

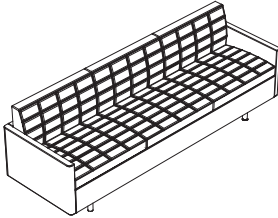
	Product Number	Depth	Width	Height	Basic Price	Upholstery
Tuxedo Classic • Sofa <i>quilted</i> 	SZ3ABQ	28	88	30	\$6,050	<i>Basic/COM Price does not include fabric. Refer to the upholstery upcharge pages for fabric and COL pricing. 1 yard = 18 sq. ft.</i>
	COM/COL..... 14 yards, 252 sq. ft. Seat height 17 3/4" Arm height 23" Seat HR foam, Dacron, and polyfoam cushions Base solid ash or walnut					

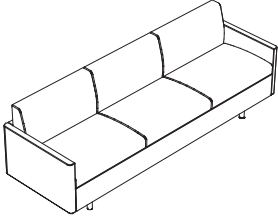
Tuxedo Classic • Sofa <i>non-quilted</i> 	SZ3ABN	28	88	30	\$5,635	<i>Basic/COM Price does not include fabric. Refer to the upholstery upcharge pages for fabric and COL pricing. 1 yard = 18 sq. ft.</i>
	COM/COL..... 14 yards, 252 sq. ft. Seat height 17 3/4" Arm height 23" Seat HR foam, Dacron, and polyfoam cushions Base solid ash or walnut					

Specify

Upholstery

Base

Fire Retardancy (specify NOCAL)

See Geiger occasional tables pricebook for Tuxedo component occasional tables.

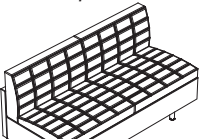
	Product Number	Depth	Width	Height	Basic Price	Upholstery
Tuxedo Classic • Connecting Settee <i>armless, quilted</i> 	SZ2ANQ <i>connects to adjacent seat on right and left</i>	28	56	30	\$3,710	<i>Basic/COM Price does not include fabric. Refer to the upholstery upcharge pages for fabric and COL pricing. 1 yard = 18 sq. ft.</i>
	<i>COM/COL..... 8 yards, 144 sq. ft.</i> <i>Seat height 17 3/4"</i> <i>Seat..... HR foam, Dacron, and polyfoam cushions</i> <i>Base solid ash or walnut</i>					

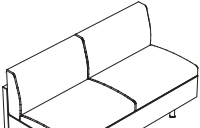
Tuxedo Classic • Connecting Settee <i>armless, non-quilted</i> 	SZ2ANN <i>connects to adjacent seat on right and left</i>	28	56	30	\$3,425	<i>Basic/COM Price does not include fabric. Refer to the upholstery upcharge pages for fabric and COL pricing. 1 yard = 18 sq. ft.</i>
	<i>COM/COL..... 8 yards, 144 sq. ft.</i> <i>Seat height 17 3/4"</i> <i>Seat..... HR foam, Dacron, and polyfoam cushions</i> <i>Base solid ash or walnut</i>					

Specify

Upholstery See Geiger occasional tables pricebook for Tuxedo component occasional tables.
 Base
 Fire Retardancy (specify NOCAL)

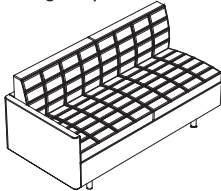
	Product Number	Depth	Width	Height	Basic Price	Upholstery
Tuxedo Classic • Connecting Settee arm right, quilted 	SZ2ARQ connects to adjacent seat on left COM/COL..... 9 1/4 yards, 166 1/2 sq. ft. Seat height 17 3/4" Arm height 23" Seat HR foam, Dacron, and polyfoam cushions Base solid ash or walnut	28	58	30	\$4,095	<i>Basic/COM Price does not include fabric. Refer to the upholstery upcharge pages for fabric and COL pricing. 1 yard = 18 sq. ft.</i>

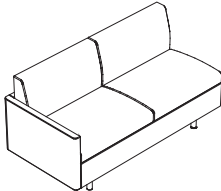
Tuxedo Classic • Connecting Settee arm right non-quilted 	SZ2ARN connects to adjacent seat on left COM/COL..... 9 1/4 yards, 166 1/2 sq. ft. Seat height 17 3/4" Arm height 23" Seat HR foam, Dacron, and polyfoam cushions Base solid ash or walnut	28	58	30	\$3,820	<i>Basic/COM Price does not include fabric. Refer to the upholstery upcharge pages for fabric and COL pricing. 1 yard = 18 sq. ft.</i>
--	---	----	----	----	---------	--

Specify

Upholstery
 Base
 Fire Retardancy (specify NOCAL)

See Geiger occasional tables pricebook for Tuxedo component occasional tables.

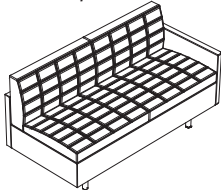
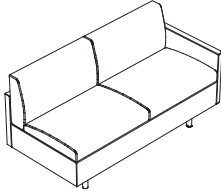
	Product Number	Depth	Width	Height	Basic Price	Upholstery
Tuxedo Classic • Connecting Settee arm left, quilted 	SZ2ALQ connects to adjacent seat on right COM/COL..... 9 1/4 yards, 166 1/2 sq. ft. Seat height 17 3/4" Arm height 23" Seat HR foam, Dacron, and polyfoam cushions Base solid ash or walnut	28	58	30	\$4,095	<i>Basic/COM Price does not include fabric. Refer to the upholstery upcharge pages for fabric and COL pricing. 1 yard = 18 sq. ft.</i>
Tuxedo Classic • Connecting Settee arm left, non-quilted 	SZ2ALN connects to adjacent seat on right COM/COL..... 9 1/4 yards, 166 1/2 sq. ft. Seat height 17 3/4" Arm height 23" Seat HR foam, Dacron, and polyfoam cushions Base solid ash or walnut	28	58	30	\$3,820	<i>Basic/COM Price does not include fabric. Refer to the upholstery upcharge pages for fabric and COL pricing. 1 yard = 18 sq. ft.</i>

Specify

Upholstery
 Base
 Fire Retardancy (specify NOCAL)

See Geiger occasional tables pricebook for Tuxedo component occasional tables.

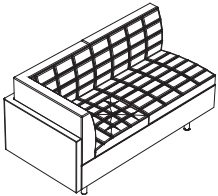
	Product Number	Depth	Width	Height	Basic Price	Upholstery
Tuxedo Classic • Connecting Corner Settee corner right, armless left, quilted 	SZ2CRQ connects to adjacent seat on left and right COM/COL..... 10 1/2 yards, 189 sq. ft. Seat height 17 3/4" Arm height 23" Seat Height..... 17 3/4" Seat..... HR foam, Dacron, and polyfoam cushions Base solid ash or walnut	28	56	30	\$4,650	<i>Basic/COM Price does not include fabric. Refer to the upholstery upcharge pages for fabric and COL pricing. 1 yard = 18 sq. ft.</i>

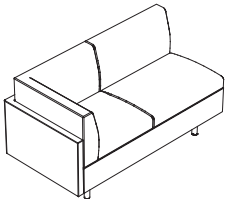
Tuxedo Classic • Connecting Corner Settee corner right, armless left, non-quilted 	SZ2CRN connects to adjacent seat on left and right COM/COL..... 10 1/2 yards, 189 sq. ft. Seat height 17 3/4" Arm height 23" Seat Height..... 17 3/4" Seat..... HR foam, Dacron, and polyfoam cushions Base solid ash or walnut	28	56	30	\$4,320	<i>Basic/COM Price does not include fabric. Refer to the upholstery upcharge pages for fabric and COL pricing. 1 yard = 18 sq. ft.</i>
---	---	----	----	----	---------	--

Specify

Upholstery
 Base
 Fire Retardancy (specify NOCAL)

See Geiger occasional tables pricebook for Tuxedo component occasional tables.

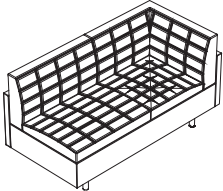
	Product Number	Depth	Width	Height	Basic Price	Upholstery
Tuxedo Classic • Connecting Corner Settee corner left, armless right, quilted	SZ2CLQ connects to adjacent seat on left and right	28	56	30	\$4,650	<i>Basic/COM Price does not include fabric. Refer to the upholstery upcharge pages for fabric and COL pricing. 1 yard = 18 sq. ft.</i>
	COM/COL..... 10 1/2 yards, 189 sq. ft. Seat height 17 3/4" Arm height 23" Seat Height..... 17 3/4" Seat..... HR foam, Dacron, and polyfoam cushions Base solid ash or walnut					

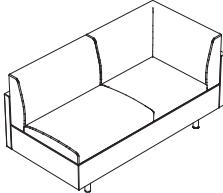
Tuxedo Classic • Connecting Corner Settee corner left, armless right, non-quilted	SZ2CLN connects to adjacent seat on left and right	28	56	30	\$4,320	<i>Basic/COM Price does not include fabric. Refer to the upholstery upcharge pages for fabric and COL pricing. 1 yard = 18 sq. ft.</i>
	COM/COL..... 10 1/2 yards, 189 sq. ft. Seat height 17 3/4" Arm height 23" Seat Height..... 17 3/4" Seat..... HR foam, Dacron, and polyfoam cushions Base solid ash or walnut					

Specify

Upholstery
 Base
 Fire Retardancy (specify NOCAL)

See Geiger occasional tables pricebook for Tuxedo component occasional tables.

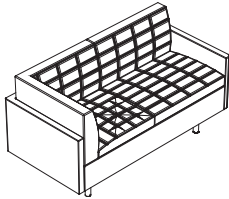
	Product Number	Depth	Width	Height	Basic Price	Upholstery
Tuxedo Classic • Connecting Corner Settee <i>corner right, arm left, quilted</i>	SZ2ZRQ <i>connects to adjacent seat on right</i>	28	58	30	\$5,040	<i>Basic/COM Price does not include fabric. Refer to the upholstery upcharge pages for fabric and COL pricing. 1 yard = 18 sq. ft.</i>
	COM/COL..... 11 3/4 yards, 211 1/2 sq. ft. Seat height 17 3/4" Arm height 23" Seat Height..... 17 3/4" Seat..... HR foam, Dacron, and polyfoam cushions Base solid ash or walnut					

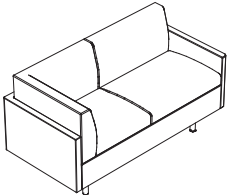
Tuxedo Classic • Connecting Corner Settee <i>corner right, arm left, non-quilted</i>	SZ2ZRN <i>connects to adjacent seat on right</i>	28	58	30	\$4,705	<i>Basic/COM Price does not include fabric. Refer to the upholstery upcharge pages for fabric and COL pricing. 1 yard = 18 sq. ft.</i>
	COM/COL..... 11 3/4 yards, 211 1/2 sq. ft. Seat height 17 3/4" Arm height 23" Seat Height..... 17 3/4" Seat..... HR foam, Dacron, and polyfoam cushions Base solid ash or walnut					

Specify

Upholstery
 Base
 Fire Retardancy (specify NOCAL)

See Geiger occasional tables pricebook for Tuxedo component occasional tables.

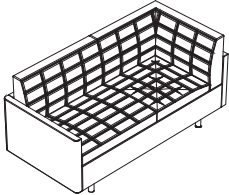
	Product Number	Depth	Width	Height	Basic Price	Upholstery
Tuxedo Classic • Connecting Corner Settee <i>corner left, arm right, quilted</i>	SZ2ZLQ <i>connects to adjacent seat on left</i>	28	58	30	\$5,040	<i>Basic/COM Price does not include fabric. Refer to the upholstery upcharge pages for fabric and COL pricing. 1 yard = 18 sq. ft.</i>
	COM/COL..... 11 3/4 yards, 211 1/2 sq. ft. Seat height 17 3/4" Arm height 23" Seat Height..... 17 3/4" Seat..... HR foam, Dacron, and polyfoam cushions Base solid ash or walnut					

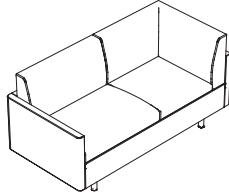
Tuxedo Classic • Connecting Corner Settee <i>corner left, arm right, non-quilted</i>	SZ2ZLN <i>connects to adjacent seat on left</i>	28	58	30	\$4,705	<i>Basic/COM Price does not include fabric. Refer to the upholstery upcharge pages for fabric and COL pricing. 1 yard = 18 sq. ft.</i>
	COM/COL..... 11 3/4 yards, 211 1/2 sq. ft. Seat height 17 3/4" Arm height 23" Seat Height..... 17 3/4" Seat..... HR foam, Dacron, and polyfoam cushions Base solid ash or walnut					

Specify

Upholstery
 Base
 Fire Retardancy (specify NOCAL)

See Geiger occasional tables pricebook for Tuxedo component occasional tables.

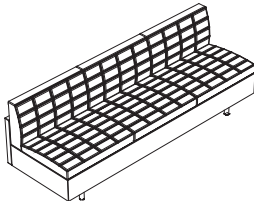
	Product Number	Depth	Width	Height	Basic Price	Upholstery
Tuxedo Classic • Connecting Sofa <i>armless, quilted</i> 	SZ3ANQ <i>connects to adjacent seat on left and right</i>	28	84	30	\$5,280	<i>Basic/COM Price does not include fabric. Refer to the upholstery upcharge pages for fabric and COL pricing. 1 yard = 18 sq. ft.</i>
	COM/COL..... 11 1/2 yards, 207 sq. ft. Seat height 17 3/4" Seat HR foam, Dacron, and polyfoam cushions Base solid ash or walnut					

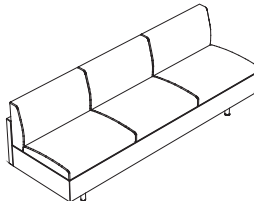
Tuxedo Classic • Connecting Sofa <i>armless, non-quilted</i> 	SZ3ANN <i>connects to adjacent seat on left and right</i>	28	84	30	\$4,745	<i>Basic/COM Price does not include fabric. Refer to the upholstery upcharge pages for fabric and COL pricing. 1 yard = 18 sq. ft.</i>
	COM/COL..... 11 1/2 yards, 207 sq. ft. Seat height 17 3/4" Seat HR foam, Dacron, and polyfoam cushions Base solid ash or walnut					

Specify

Upholstery
 Base
 Fire Retardancy (specify NOCAL)

See Geiger occasional tables pricebook for Tuxedo component occasional tables.

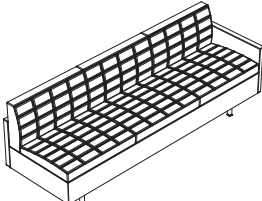
	Product Number	Depth	Width	Height	Basic Price	Upholstery
Tuxedo Classic • Connecting Sofa <i>arm left, quilted</i> 	SZ3ALQ <i>connects to adjacent seat on right</i>	28	86	30	\$5,660	<i>Basic/COM Price does not include fabric. Refer to the upholstery upcharge pages for fabric and COL pricing. 1 yard = 18 sq. ft.</i>
	COM/COL..... 12 3/4 yards, 229 1/2 sq. ft. Seat height 17 3/4" Arm height 23" Seat HR foam, Dacron, and polyfoam cushions Base solid ash or walnut					

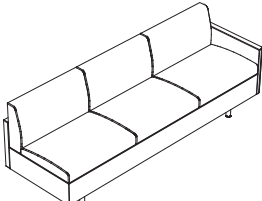
Tuxedo Classic • Connecting Sofa <i>arm left, non-quilted</i> 	SZ3ALN <i>connects to adjacent seat on right</i>	28	86	30	\$5,250	<i>Basic/COM Price does not include fabric. Refer to the upholstery upcharge pages for fabric and COL pricing. 1 yard = 18 sq. ft.</i>
	COM/COL..... 12 3/4 yards, 229 1/2 sq. ft. Seat height 17 3/4" Arm height 23" Seat HR foam, Dacron, and polyfoam cushions Base solid ash or walnut					

Specify

Upholstery
 Base
 Fire Retardancy (specify NOCAL)

See Geiger occasional tables pricebook for Tuxedo component occasional tables.

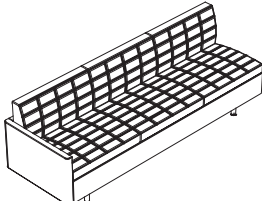
	Product Number	Depth	Width	Height	Basic Price	Upholstery
Tuxedo Classic • Connecting Sofa arm right, quilted 	SZ3ARQ connects to adjacent seat on left COM/COL..... 12 3/4 yards, 229 1/2 sq. ft. Seat height 17 3/4" Arm height 23" Seat HR foam, Dacron, and polyfoam cushions Base solid ash or walnut	28	86	30	\$5,660	<i>Basic/COM Price does not include fabric. Refer to the upholstery upcharge pages for fabric and COL pricing. 1 yard = 18 sq. ft.</i>

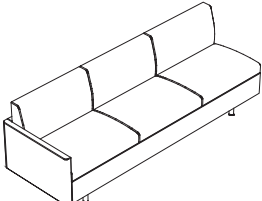
Tuxedo Classic • Connecting Sofa arm right, non-quilted 	SZ3ARN connects to adjacent seat on left COM/COL..... 12 3/4 yards, 229 1/2 sq. ft. Seat height 17 3/4" Arm height 23" Seat HR foam, Dacron, and polyfoam cushions Base solid ash or walnut	28	86	30	\$5,250	<i>Basic/COM Price does not include fabric. Refer to the upholstery upcharge pages for fabric and COL pricing. 1 yard = 18 sq. ft.</i>
---	--	----	----	----	---------	--

Specify

Upholstery
 Base
 Fire Retardancy (specify NOCAL)

See Geiger occasional tables pricebook for Tuxedo component occasional tables.

	Product Number	Depth	Width	Height	Basic Price	Upholstery
Tuxedo Classic • Connecting Corner Sofa corner right, armless left, quilted	SZ3CRQ connects to adjacent seat on left and right	28	84	30	\$6,175	<i>Basic/COM Price does not include fabric. Refer to the upholstery upcharge pages for fabric and COL pricing. 1 yard = 18 sq. ft.</i>

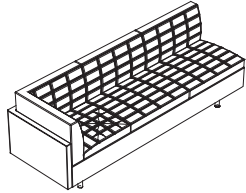

COM/COL..... 14 1/2 yards, 261 sq. ft.
 Seat height 17 3/4"
 Seat..... HR foam, Dacron, and polyfoam cushions
 Base solid ash or walnut

Tuxedo Classic • Connecting Corner Sofa corner right, armless left, non-quilted	SZ3CRN connects to adjacent seat on left and right	28	84	30	\$5,705	<i>Basic/COM Price does not include fabric. Refer to the upholstery upcharge pages for fabric and COL pricing. 1 yard = 18 sq. ft.</i>
---	--	----	----	----	---------	--

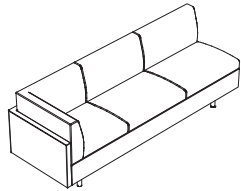

COM/COL..... 14 1/2 yards, 261 sq. ft.
 Seat height 17 3/4"
 Seat..... HR foam, Dacron, and polyfoam cushions
 Base solid ash or walnut

Specify

Upholstery
 Base
 Fire Retardancy (specify NOCAL)

See Geiger occasional tables pricebook for Tuxedo component occasional tables.

	Product Number	Depth	Width	Height	Basic Price	Upholstery
Tuxedo Classic • Connecting Corner Sofa corner left, armless right, quilted	SZ3CLQ connects to adjacent seat on left and right	28	84	30	\$6,175	<i>Basic/COM Price does not include fabric. Refer to the upholstery upcharge pages for fabric and COL pricing. 1 yard = 18 sq. ft.</i>

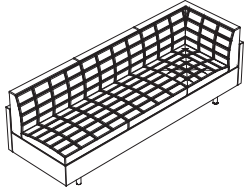

COM/COL..... 14 1/2 yards, 261 sq. ft.
 Seat height 17 3/4"
 Seat HR foam, Dacron, and polyfoam cushions
 Base solid ash or walnut

Tuxedo Classic • Connecting Corner Sofa corner left, armless right, non-quilted	SZ3CLN connects to adjacent seat on left and right	28	84	30	\$5,705	<i>Basic/COM Price does not include fabric. Refer to the upholstery upcharge pages for fabric and COL pricing. 1 yard = 18 sq. ft.</i>
---	--	----	----	----	---------	--

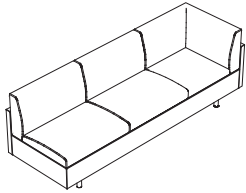

COM/COL..... 14 1/2 yards, 261 sq. ft.
 Seat height 17 3/4"
 Seat HR foam, Dacron, and polyfoam cushions
 Base solid ash or walnut

Specify

Upholstery
 Base
 Fire Retardancy (specify NOCAL)

See Geiger occasional tables pricebook for Tuxedo component occasional tables.

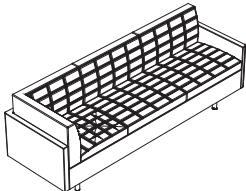
	Product Number	Depth	Width	Height	Basic Price	Upholstery
Tuxedo Classic • Connecting Corner Sofa <i>corner right, arm left, quilted</i> 	SZ3ZRQ <i>connects to adjacent seat on right</i>	28	86	30	\$6,565	<i>Basic/COM Price does not include fabric. Refer to the upholstery upcharge pages for fabric and COL pricing. 1 yard = 18 sq. ft.</i>
	COM/COL..... 15 3/4 yards, 283 1/2 sq. ft. Seat height 17 3/4" Arm height 23" Seat HR foam, Dacron, and polyfoam cushions Base solid ash or walnut					

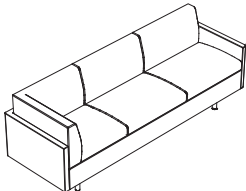
Tuxedo Classic • Connecting Corner Sofa <i>corner right, arm left, non-quilted</i> 	SZ3ZRN <i>connects to adjacent seat on right</i>	28	86	30	\$6,090	<i>Basic/COM Price does not include fabric. Refer to the upholstery upcharge pages for fabric and COL pricing. 1 yard = 18 sq. ft.</i>
	COM/COL..... 15 3/4 yards, 283 1/2 sq. ft. Seat height 17 3/4" Arm height 23" Seat HR foam, Dacron, and polyfoam cushions Base solid ash or walnut					

Specify

Upholstery See Geiger occasional tables pricebook for Tuxedo component occasional tables.
 Base
 Fire Retardancy (specify NOCAL)

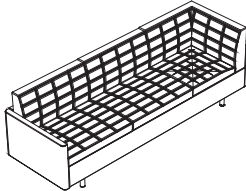
	Product Number	Depth	Width	Height	Basic Price	Upholstery
Tuxedo Classic • Connecting Corner Sofa corner left, arm right, quilted 	SZ3ZLQ connects to adjacent seat on left COM/COL..... 15 3/4 yards, 283 1/2 sq. ft. Seat height 17 3/4" Arm height 23" Seat HR foam, Dacron, and polyfoam cushions Base solid ash or walnut	28	86	30	\$6,565	<i>Basic/COM Price does not include fabric. Refer to the upholstery upcharge pages for fabric and COL pricing. 1 yard = 18 sq. ft.</i>

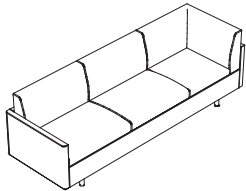
Tuxedo Classic • Connecting Corner Sofa corner left, arm right, non-quilted 	SZ3ZLN connects to adjacent seat on left COM/COL..... 15 3/4 yards, 283 1/2 sq. ft. Seat height 17 3/4" Arm height 23" Seat HR foam, Dacron, and polyfoam cushions Base solid ash or walnut	28	86	30	\$6,090	<i>Basic/COM Price does not include fabric. Refer to the upholstery upcharge pages for fabric and COL pricing. 1 yard = 18 sq. ft.</i>
---	--	----	----	----	---------	--

Specify

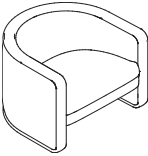
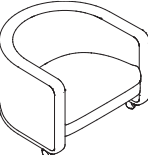
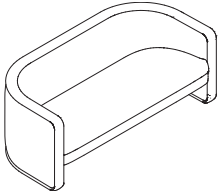
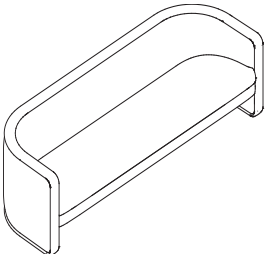

Upholstery
 Base
 Fire Retardancy (specify NOCAL)

See Geiger occasional tables pricebook for Tuxedo component occasional tables.

	Product Number	Depth	Width	Height	Basic Price	Upholstery
	U-Series • Lounge Chair					
	2003	29 1/2	31	23 1/4	\$2,050	<i>Basic/COM Price does not include fabric. Refer to the upholstery upcharge pages for fabric and COL pricing. 1 yard = 18 sq. ft.</i>
<i>with casters</i>					\$2,150	
 <i>with casters</i>	2004	29 1/2	31	23 1/4		
	COM/COL (Shell back)..... 3 yards, 54 sq. ft. COM/COL (Seat cushion, arm) 3. 1/2 yards, 63 sq. ft. Seat height 16 1/4" Arm height 23 1/4"					
	U-Series • Settee					
	2006	29 1/2	60 1/4	23 1/4	\$3,100	<i>Basic/COM Price does not include fabric. Refer to the upholstery upcharge pages for fabric and COL pricing. 1 yard = 18 sq. ft.</i>
COM/COL (Shell back)..... 4 3/4 yards, 85 1/2 sq. ft. COM/COL (Seat cushion, arm) 4 1/4 yards, 76 1/2 sq. ft. Seat height 16 1/4" Arm height 23 1/4"						
	U-Series • Sofa					
	2007	29 1/2	84 1/4	23 1/4	\$4,000	<i>Basic/COM Price does not include fabric. Refer to the upholstery upcharge pages for fabric and COL pricing. 1 yard = 18 sq. ft.</i>
COM/COL (Shell back)..... 5 1/4 yards, 94 1/2 sq. ft. COM/COL (Seat cushion, arm) 4 3/4 yards, 85 1/2 sq. ft. Seat height 16 1/4" Arm height 23 1/4"						

Specify

- Upholstery 1 (Shell back)
- Upholstery 2 (Seat cushion, arm)
- Fire Retardancy (specify NOCAL)

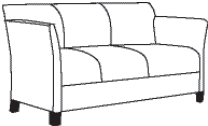
	Product Number	Depth	Width	Height	Basic Price	Upholstery
Washington Avenue • Lounge Chair 	SBWN-13125	27	29	29	\$2,100	<i>Basic/COM Price does not include fabric. Refer to the upholstery upcharge pages for fabric and COL pricing. 1 yard = 18 sq. ft.</i>
	<p>COM/COL..... 7 yards, 126 sq. ft. Seat height 17" Arm height 25" Arms hardwood with HR foam, Dacron and polyfoam Legs..... 3 1/4" black wood with 1/4" metal glide Cushion webbed deck HR foam and Dacron</p>					
Washington Avenue • Settee 	SBWN-13128	27	60	29	\$3,140	<i>Basic/COM Price does not include fabric. Refer to the upholstery upcharge pages for fabric and COL pricing. 1 yard = 18 sq. ft.</i>
	<p>COM/COL..... 9 1/2 yards, 171 sq. ft. Seat height 17" Arm height 25" Arms hardwood with HR foam, Dacron and polyfoam Legs..... 3 1/4" black wood with 1/4" metal glide Cushion webbed deck HR foam and Dacron</p>					
Washington Avenue • Sofa 	SBWN-13130	27	70	29	\$3,515	<i>Basic/COM Price does not include fabric. Refer to the upholstery upcharge pages for fabric and COL pricing. 1 yard = 18 sq. ft.</i>
	<p>COM/COL..... 10 yards, 180 sq. ft. Seat height 17" Arm height 25" Arms hardwood with HR foam, Dacron and polyfoam Legs..... 3 1/4" black wood with 1/4" metal glide Cushion webbed deck HR foam and Dacron</p>					

Specify

Upholstery
 Fire Retardancy (specify NOCAL)

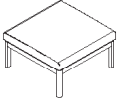
	Product Number	Depth	Width	Height	Basic Price	Upholstery
Wood Base • Ottoman 	<i>ash frame</i> TT1BA	26	26	14 1/4	\$1,380	<i>Basic/COM Price does not include fabric. Refer to the upholstery upcharge pages for fabric and COL pricing. 1 yard = 18 sq. ft.</i>
	<i>walnut frame</i> TT1BW	26	26	14 1/4	\$1,485	
<p>COM/COL..... 1 1/2 yards, 27 sq. ft. Base ash or walnut Cushion foam and Dacron</p>						

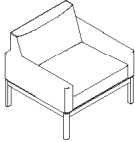
Wood Base • Club Chair 	<i>ash frame</i> TT1AA	29 1/2	32	28 1/2	\$2,655	<i>Basic/COM Price does not include fabric. Refer to the upholstery upcharge pages for fabric and COL pricing. 1 yard = 18 sq. ft.</i>
	<i>walnut frame</i> TT1AW	29 1/2	32	28 1/2	\$2,765	
<p>COM/COL..... 3 1/4 yards, 58 1/2 sq. ft. Seat height 17 1/2" Seat depth 21 1/4" Arm height 21 3/4" Base ash or walnut Cushion foam and Dacron</p>						

Specify

Upholstery
 Base
 Fire Retardancy (specify NOCAL)

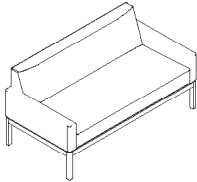
	Product Number	Depth	Width	Height	Basic Price	Upholstery
Wood Base • Settee 	ash frame TT2AA	29 1/2	58	28 1/2	\$3,830	<i>Basic/COM Price does not include fabric. Refer to the upholstery upcharge pages for fabric and COL pricing. 1 yard = 18 sq. ft.</i>
	walnut frame TT2AW	29 1/2	58	28 1/2	\$4,040	
<p>COM/COL..... 5 1/4 yards, 94 1/2 sq. ft. Seat height 17 1/2" Seat depth 21 1/4" Arm height 21 3/4" Base ash or walnut Cushion foam and Dacron</p>						

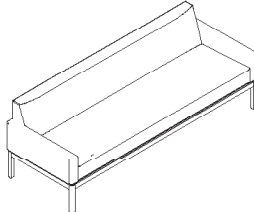
Wood Base • Sofa 	ash frame TT3AA	29 1/2	84	28 1/2	\$4,680	<i>Basic/COM Price does not include fabric. Refer to the upholstery upcharge pages for fabric and COL pricing. 1 yard = 18 sq. ft.</i>
	walnut frame TT3AW	29 1/2	84	28 1/2	\$5,005	
<p>COM/COL..... 7 1/4 yards, 130 1/2 sq. ft. Seat height 17 1/2" Seat depth 21 1/4" Arm height 21 3/4" Base ash or walnut Cushion foam and Dacron</p>						

Specify

Upholstery

Base

Fire Retardancy (specify NOCAL)

Product Number	Page	Product Number	Page	Product Number	Page	Product Number	Page
2003.....	82	SK4B.....	39	ST3ARN.....	58	SZ1ABN.....	65
2004.....	82	SK5.....	41	ST3ARQ.....	58	SZ1ABQ.....	65
2006.....	82	SK6.....	40	ST3BN.....	49	SZ2ABN.....	66
2007.....	82	SSJFA.....	32	ST3BQ.....	49	SZ2ABQ.....	66
PTA.....	35	SSJFF.....	32	ST3CLAN.....	56	SZ2ALN.....	70
PTB.....	35	SSJFW.....	32	ST3CLAQ.....	56	SZ2ALQ.....	70
PTC.....	35	SSJGA.....	32	ST3CLNN.....	57	SZ2ANN.....	68
PTD.....	35	SSJGF.....	32	ST3CLNQ.....	57	SZ2ANQ.....	68
SBN5H.....	44	SSJGW.....	32	ST3CRAN.....	56	SZ2ARN.....	69
SBN6.....	45	SSJJA.....	33	ST3CRAQ.....	56	SZ2ARQ.....	69
SBR4N.....	31	SSJFF.....	33	ST3CRNN.....	57	SZ2CLN.....	72
SBRA-43.....	43	SSJJW.....	33	ST3CRNQ.....	57	SZ2CLQ.....	72
SBRA-72.....	43	SSJKA.....	33	ST3DN.....	49	SZ2CRN.....	71
SBRA-84.....	43	SSJKF.....	33	ST3DQ.....	49	SZ2CRQ.....	71
SBRA-96.....	43	SSJKW.....	33	ST3NN.....	55	SZ2ZLN.....	74
SBSC-1098.....	46	ST1AN.....	50	ST3NQ.....	55	SZ2ZLQ.....	74
SBSD-1099.....	46	ST1AQ.....	50	STGP.....	64	SZ2ZRN.....	73
SBSU-1060.....	47	ST1BN.....	48	SVV4A.....	28	SZ2ZRQ.....	73
SBWN-13125.....	82	ST1BQ.....	48	SVV4W.....	28	SZ3ABN.....	67
SBWN-13128.....	82	ST1NN.....	50	SVV5A.....	29	SZ3ABQ.....	67
SBWN-13130.....	82	ST1NQ.....	50	SVV5W.....	29	SZ3ALN.....	76
SES1A.....	34	ST2ALN.....	54	SVV6A.....	30	SZ3ALQ.....	76
SES1W.....	34	ST2ALQ.....	54	SVV6W.....	30	SZ3ANN.....	75
SES3A.....	34	ST2AN.....	51	SX1ALN.....	60	SZ3ANQ.....	75
SES3W.....	34	ST2AQ.....	51	SX1ALQ.....	60	SZ3ARN.....	77
SES4A.....	34	ST2ARN.....	54	SX1ARN.....	60	SZ3ARQ.....	77
SES4W.....	34	ST2ARQ.....	54	SX1ARQ.....	60	SZ3CLN.....	79
SJAA.....	42	ST2BN.....	48	SX1NLN.....	59	SZ3CLQ.....	79
SJAW.....	42	ST2BQ.....	48	SX1NLQ.....	59	SZ3CRN.....	78
SJBA.....	42	ST2CLAN.....	52	SX1NRN.....	59	SZ3CRQ.....	78
SJBW.....	42	ST2CLAQ.....	52	SX1NRQ.....	59	SZ3ZLN.....	81
SJCA.....	42	ST2CLNN.....	53	SX2ALN.....	62	SZ3ZLQ.....	81
SJCW.....	42	ST2CLNQ.....	53	SX2ALQ.....	62	SZ3ZRN.....	80
SK1.....	36	ST2CRAN.....	52	SX2ARN.....	62	SZ3ZRQ.....	80
SK2A.....	37	ST2CRAQ.....	52	SX2ARQ.....	62	TT1AA.....	83
SK2CL.....	37	ST2CRNN.....	53	SX2CLN.....	63	TT1AW.....	83
SK2CR.....	37	ST2CRNQ.....	53	SX2CLQ.....	63	TT1BA.....	83
SK2N.....	37	ST2NN.....	51	SX2CRN.....	63	TT1BW.....	83
SK3A.....	38	ST2NQ.....	51	SX2CRQ.....	63	TT2AA.....	84
SK3CL.....	38	ST3ALN.....	58	SX2NLN.....	61	TT2AW.....	84
SK3CR.....	38	ST3ALQ.....	58	SX2NLQ.....	61	TT3AA.....	84
SK3N.....	38	ST3AN.....	55	SX2NRN.....	61	TT3AW.....	84
SK4A.....	39	ST3AQ.....	55	SX2NRQ.....	61		

- © 2018 Geiger International, Inc. All rights reserved.
 - ® Geiger International is a registered trademark of Geiger International, Inc.
 - ® Herman Miller is a registered trademark of Herman Miller, Inc.
 - ® Edelman Leather is a registered trademark of Edelman Leather, LLC.
 - ® DACRON is a registered trademark of INVISTA S.a r.l.
 - ™ Brabo, Bumper, Clamshell, Crosshatch, Museum Bench, Nessel, Rapport, Rolled Arm, Saiba, Scissor, Sled, Tuxedo Classic Lounge, Tuxedo Component Lounge, Washington Avenue and Wood Base are trademarks of Geiger International, Inc., and/or of its independent designers.
 - ™ The Geiger logo and Bristol are trademarks of Geiger International, Inc., and/or of its independent designers.
 - ™ Bento, Chain, Cord, Crossing, Glaze, Glisten, Gloss, Grasscloth, Grosgrain, Herman Miller Leather, Hopsak, Horizon, Lanalux, Linomix, Loft, MCL Leather, Noble, Railroad, Savannah, Sironetta, Slant, Strata, Superweave, and Twist are trademarks of Herman Miller, Inc., and/or of its independent designers.
 - ™ A Band Apart, Abacus, Abacus Standard, Across, Agency, Akimbo, Alloy, Allusion, Alpaca Epingle, Alpaca Herringbone, Alpaca Velvet, Alter, Anagram, Apt, Aria, Article, Bavaria, Bavaria Stripe, Beam, Bespoke Stripe, Big Stripe, Blip, Blumen, Borders, Brindle, Brushed Camel, Brushed Merino, Canvas, Centric, Checker, Checker Split, Chenille Cord, Circuit, Coach Cloth, Cobblestone, Coincide, Coincide High Performance, Colline, Colorwheel, Compartment, Cotton Velvet, Couple, Crew, Crush, Dandy, Dart, Deconstructed Rose, Design 9297, Dingbats, Disperse, Ditto, Divina MD, Double Triangles, Dwell, Epingle , Epingle Stripe, Exaggerated Plaid, Exchange, Facets, Floret, Fluent, Fluent Crypton, Focus, Garden, Geometri, Gradient, Hallingdal, Harlow, Herringbone Stripe, Hours, Ingenua, Instill, Jacobs Coat, Kindred, Layers Garden, Layers Garden Double, Layers Park, Layers Park Double, Layers Vineyard, Layers Vineyard Small, Ledger, Letters, Manner, Massive Paisley, Mechanism, Melange Tweed, Meld, Metric, Milestone, Millerstripe, Minimal, Mister, Mode, Mohair Supreme, Monk's Wool, Murmur, Octave, Offset, Omen, Optik, Orakelblume, Ottoman Stripe, Overture, Painted Stripe, Parched Silk, Pare, Paver, Pitch, Plait, Point, Regatta, Repeat Classic Stripe, Repeat Dot Ring, Rove, Rule, Runner, Runner Standard, Salon, Scuba, Sequence, Shuttle Standard, Silk Canvas, Skein, Soft Tweed, Steady, Steady Crypton, Steelcut, Steelcut Trio, Strand, Stripes, Sudden, Tack, Tangram, Telary, The Firm, The Story of My Life, Tonica, Tonus, Toostripe, Topas, Trait, Transport, Trees, Trio, Unisol, Urban, Vases, Vineyard, Vionette, Voyage, Waterborn, Wool Rib, and Wool Velvet are trademarks of Maharam, Inc. and/or of its independent designers. Edelman and VisionKnit are property of their respective companies. All rights reserved.
- Edelman, Guilford of Maine, and Maharam are property of their respective companies. All rights reserved.