



GSA prices effective January 30, 2023
(based on October 3, 2022, commercial price list)
Published June 2024

NaughtOne

General Services Administration Federal Supply Service Authorized Federal Supply Schedule Price List

Online access to contract ordering information, terms and conditions, up-to-date pricing, and the option to create an electronic delivery order is available through GSA Advantage!®, a menu-driven database system.

The Internet address for GSA Advantage! is www.gsaadvantage.gov.

Office Furniture
FSC/PSC 7110/7125
Contract Number: GS-03F-036DA
UEI: Q2K3MSZ843D8
Contract Period: December 21, 2015—December 20, 2025

MillerKnoll, Inc.
855 East Main Avenue
Zeeland, Michigan 49464
(616) 654 3000 Phone
(616) 654 8278 Fax
www.HermanMiller.com/government

Business Size: Large

Contract Information

1a. Special Item Numbers (SIN)

SIN 33721

Furniture Systems, Computer Furniture, Filing and Storage, Tables and Accessories, Upholstered Seating and Multi-Purpose Seating, Project Management, Reconfiguration and Relocation Services, Design/Layout and Installation Services

SIN 33721P

Packaged Offices

SIN 337127

Modular Laboratory Furniture Systems

SIN 339113H

Healthcare Furniture

SIN OLM

Order-Level Materials (OLMs)

This SIN is only for products and/or services used in direct support of the purchase of new furniture. It requires approval from the ordering Contract Officer. Please contact your local MillerKnoll Inc. representative to discuss the appropriate use of this SIN.

SIN 532289

Leasing

Contact MillerKnoll Inc participating government dealer for current leasing information.

1b. Lowest Priced Model

SIN 33721:	BVP3.S	\$7.27
SIN 33127:	TW113	\$5.81
SIN 339113H:	CR900NR	\$483.80

1c. Service Rates

Project Management

Furniture Project Manager: \$64.75 per hour
 Furniture Project Coordinator: \$49.00 per hour
 Build-Out Project Manager: \$80.00 per hour

Reconfiguration and Relocation Services

Not to exceed \$55 per hour.

See * Additional Notes for Installation & Reconfiguration and Relocation Services.

Design/Layout

Not to exceed \$65 per hour.

Installation Services

Not to exceed \$55 per hour (\$82.50 per hour for after-hours Installation).

See * Additional Notes for Installation & Reconfiguration and Relocation Services.

2. Maximum Order

SIN 33721, 337127, NEW, OLM

\$250,000 net product value

SIN 33721P

\$250,000 net value

SIN 339113H

\$500,000 net product value

3. Minimum Order

\$100 net

4. Geographic Coverage

Continental U.S.

Orders for Alaska, Hawaii, and Puerto Rico will be shipped F.O.B. inland carrier point of exportation.

5. Point of Production

Zeeland, Ottawa County, Michigan

Spring Lake, Ottawa County, Michigan

Elland, Yorkshire, United Kingdom

Hildebran, Burke County, North Carolina, USA

6. Pricing

Prices shown are list. Discounts include Industrial Funding Fee.

SIN 33721

Standard Lead Time, Single Order Net Purchase \$100 - 250,000, includes approved Herman Miller Options Products.

Product Line	Discount From List
Action Office 1	73.8%
Action Office 2	73.8%
Aeron	64.5%
Ambit Workspace Solutions	74.3%
Aside	64.2%
C-Style Overhead Storage	73.8%
Canvas Office Landscape Channel	74.8%
Canvas Office Landscape Dock	74.8%
Canvas Metal Desk	74.8%
Canvas Office Landscape Metal Storage	74.8%
Canvas Office Landscape Private Office	74.8%
Canvas Office Landscape Wood Storage	74.8%
Canvas Office Landscape Vista	74.8%
Canvas Office Landscape Wall	74.8%
Caper	61.5%
Commend Nurses Station	73.3%
Cosm	61.7%
Eames® Aluminum Group	58.7%
Eames Conference & Dining Tables	73.6%
Easton Family	54.91%
Embody	59.7%
Energy Distribution Systems	73.8%
Ethospace System	73.8%
Everywhere™ Tables	73.8%
Exclave	61.7%
Fuld	59.7%

Contract Information

continued

Headway™ Tables	73.8%
Intent Solution	58.7%
Layout Studio®	60.7%
Lighting	73.8%
Lino	63.7%
Meridian Laterals	67.3%
Meridian Pedestals	64.2%
Meridian Towers	62.7%
Meridian Storage	62.7%
Mirra 2	61.7%
Motia Tables	73.8%
NaughtOne	50.0%
Nemschoff	54.91%
Nevi™ Tables	73.8%
Nevi Link	73.8%
OE1 Boundary	72.8%
OE1 Community Elements	61.7%
OE1 Micro Packs	73.8%
OE1 Storage	72.8%
OE1 Tables and Benching	73.8%
Overlay™	62.7%
Plex® Lounge Furniture	59.5%
Public Office Landscape	61.7%
Renew™ Tables	73.8%
Renew Link	73.8%
Sayl	62.2%
Setu	59.7%
Swoop Lounge Furniture	60.7%
Thrive Portfolio	62.0%
Thrive Portfolio-CBS Products Extension	62.0%
Tu Lateral Files	74.3%
Tu Pedestals	73.8%
Tu Storage	74.3%
Tu Towers	74.3%
Tu Wood Cases	74.3%
Tu Wood Cubbies	74.3%
Tu Wood Credenzas	74.3%
Tu Wood Pedestals	74.3%
Tu Wood Towers	74.3%
Valor™ Family	54.91%
Verus	63.7%
Zeph	60.2%

Services

Please refer to section 19 for Terms and Conditions of Installation/ Reconfiguration and Relocation Services.

Project Management

Services under this SIN may be used only in conjunction with the purchase of new furniture. Please contact your local MillerKnoll Inc. representative to discuss the available labor categories (listed below). The hourly rates listed are “Not To Exceed” or “NTE” values.

Furniture Project Manager: \$64.75 per hour
 Furniture Project Coordinator: \$49.00 per hour
 Build-Out Project Manager: \$80.00 per hour

Reconfiguration and Relocation Services

Reconfiguration and Relocation Services will be provided by MillerKnoll Inc. or its participating dealer based on a fee not to exceed \$55 per hour.

See * Additional Notes for Installation & Reconfiguration and Relocation Services.

Design/Layout

Design service will be provided by MillerKnoll Inc. or its participating dealer based on a fee not to exceed \$65 per hour.

Installation Services

Installation Services will be provided by MillerKnoll Inc. or its participating dealer based on a fee not to exceed \$55 per hour (\$82.50 per hour for after-hours Installation).

See * Additional Notes for Installation & Reconfiguration and Relocation Services.

SIN 337127

Standard Lead Time, Single Order Net Purchase \$100 - 250,000, includes approved Herman Miller Options Products.

Product Line	Discount From List
Action Lab	58.5%
Compass System	58.5%
Co/Struc System	58.5%
Healthcare Carts	18.0%
Mora System	58.5%
Bedside Cabinets	58.5%

SIN 33721P

Packaged Office Furniture - Maximum Order \$250,000 (net).

Includes packaged furniture solutions for customers needing to furnish an office.

SIN 339113H

Standard Lead Time, Single Order Net Purchase \$100 - 500,000, includes approved Herman Miller Options Products.

Product Line	Discount From List
Nemschoff Healthcare Furniture	54.91%

7. Quantity Discounts

Reference item #6.

8. Payment Terms

Net 30 days

9. Foreign Items

None

10. Time of Delivery

- a. 90 day ARO
- b. Expedited delivery: Items listed in the 10-Day section of the catalogs are available for expedited delivery.
- c. Overnight/2-day delivery: Select items may be available for overnight or 2-day delivery. Contact MillerKnoll Inc. or a participating dealer for availability and rates.
- d. Urgent requirements: Agencies may contact contractor or participating dealer to request faster delivery.

Contract Information

continued

11. F.O.B.

F.O.B. destination except Alaska, Hawaii, and Puerto Rico, which will be shipped F.O.B. inland carrier point of exportation.

12. Ordering Address

- a. MillerKnoll Inc.
Government Customer Care 0161
855 East Main Avenue
Zeeland MI 49464.
- b. For supplies and services, the ordering procedures information on Blanket Purchase Agreements (BPA's) are found in Federal Acquisition Regulation (FAR) 8.405-3.

13. Payment Address.

MillerKnoll Inc.
22764 Network Place
Chicago, IL 60673-1227

14. Warranty

MillerKnoll Inc. commercial warranty applies.

15. Export Packing Charge

Prices supplied on request.

16. Rental Maintenance and Repair Terms

Not applicable

17. Terms and Conditions of Installation/Reconfiguration and Relocation Services

* Additional Notes for Installation & Reconfiguration and Relocation Services:

FOB Destination (Drop Ship): Price includes product delivery to the site, brought to the tailgate of the truck. The purchaser is responsible for unloading.

Prices effective up to the maximum order by SIN only. Above the MO, pricing shall be negotiated on a case-by-case basis between the client and local dealer.

Standard Services are Subject to the Following Conditions:

Installation will be performed during normal weekday working hours.

Adequate facilities for delivery, unloading, moving and staging/storing the product during the installation process shall be provided.

Service work will not be hindered by other trades.

Electric, heat, and adequate elevator service will be furnished without charge.

The immediate installation area shall be complete and free of debris including the carpet/flooring before installation commences.

Any work requiring a licensed electrician is the responsibility of the buyer.

Additional Charges May Apply For:

Major Metro Markets and any non-ground floor installation.

Major Metro Markets include large population centers and urban environments.

Installation in a clinical/medical environment.

Special restrictions or limits established by local laws, ordinances or the directions of the buyer, including but not limited to restrictions on transportations of materials, street access to the job site and/or dock facilities.

Installations outside of a 50 mile radius of the servicing dealer.

Local Prevailing Wage and/or Union Labor Rates.

Any additional charges shall be quoted by the dealer and approved by the buyer prior to performance of the work.

18. Terms and Conditions of Repair Parts

Not applicable

19. Service and Distribution Points

For service and distribution points nearest you, call (800) 851 1196.

20. Participating Dealers

Access Herman Miller web site for current list of participating dealers: www.HermanMiller.com/where-to-buy/contact-a-dealer/. Select your market by using the filter.

21. Preventive Maintenance

Not applicable

22a. Special Attributes.

2022

MillerKnoll earns its 15th consecutive perfect score in Human Rights Campaign Foundation's 2022 Corporate Equality Index.

2021

The OE1 Trolley and Micro Packs are both winners of the 2021 Archiproductions international design competition in the Office Category.

MillerKnoll is named to Michigan's Best and Brightest in Wellness List for 2021.

MillerKnoll is awarded Platinum Rating in CSR by EcoVadis.

OE1 is named winner of Wallpaper's "Most Futuristic Furniture" Category as part of their first-ever Smart Space Awards.

OE1 receives the Workplace category award from Fast Company's 2021 Innovation by Design Awards.

MillerKnoll is named to Fast Company's Annual List of the World's Most Innovative Companies for 2021.

MillerKnoll is recognized as a "Disclosure Leader" by the Chemical Footprint Project (CFP).

Contract Information

continued

MillerKnoll earns its 14th consecutive perfect score in Human Rights Campaign Foundation's 2021 Corporate Equality Index.

MillerKnoll is named to Newsweek's List of America's Most Responsible Companies 2021.

Great Lakes Women's Business Council awards MillerKnoll for "Excellence in Supplier Diversity" in the Best In Class category.

2020

Herman Miller is recognized with a 2020 FSC® Leadership Award for our commitment to responsible forestry management.

Herman Miller is named one of Investor's Business Daily Top 50 Best ESG (Environmental, Social, and Corporate Governance) Companies.

Working Mother names Herman Miller as one of the Best Companies for Dads.

Herman Miller is awarded Platinum Rating in CSR by EcoVadis.

Herman Miller is named Diversity Inc 2020 Noteworthy Company for recruitment efforts, employee development opportunities, leadership accountability, and supplier diversity.

Cosm, by Studio 7.5, receives an iF Gold Award in the Office and Industry category at the iF World Design Awards 2020.

Herman Miller earns its 13th consecutive perfect score in Human Rights Campaign Foundation's 2020 Corporate Equality Index.

2019

Mora System casework, designed by Collective Ten for Herman Miller, receives silver in the Industrial and Life Science Design/Medical Furniture category at the European Product Design Awards.

Mora System casework is awarded GOOD DESIGN Award 2019, selected for design excellence and innovation.

National Minority Supplier Diversity Council (NMSDC) names Herman Miller as the 2019 Class 1 Corporation of the Year for leadership in supplier diversity.

TIME Magazine names Cosm to its list of 100 Best Inventions of 2019.

Herman Miller is named #12 Overall and #2 in Manufacturing on Investor's Business Daily Best ESG (Environmental, Social, Governance) Companies.

Herman Miller is recognized as a silver level Certified Veteran-Friendly Employer by the Michigan Veterans Affairs Agency for a commitment to veteran hiring, retention, and development.

For the second year in a row, Herman Miller receives a Gold Medal from EcoVadis in recognition of Corporate Social Responsibility achievement measured in categories of environment, labor and human rights, ethics, and sustainable procurement.

Herman Miller is named "Frontrunner" in Chemical Footprint Project by Clean Production Action for our chemical management policies and practices.

Herman Miller receives International Interior Design Association and Contract's best showroom design award in the "Large Showroom" category at NeoCon.

Herman Miller earns its 12th consecutive perfect score in Human Rights Campaign Foundation's 2019 Corporate Equality Index.

Cosm, designed by Studio 7.5 for Herman Miller, receives a Red Dot Best of the Best Product Design Award in the "Office Chairs" category.

Lino, designed by Sam Hecht and Kim Colin for Herman Miller, receives an iF Design Award in the Product Design category.

2018

Overlay, designed by Birsell+Seck, receives Interior Design Best of Year Award in the Partitions and Wall Systems category.

Herman Miller receives the "Corporation of the Year" in consumer products award from the Michigan Minority Supplier Development Council.

Herman Miller achieves the Advanced Excellence in Supplier Diversity Award from the Great Lakes Women's Business Council for doing business with women-owned suppliers.

Great Lakes Women's Business Council awards Herman Miller for "Excellence in Supplier Diversity" in the Advanced category.

WEConnect awards Herman Miller an Honorable Mention for global supplier diversity initiatives.

As one of the top-scoring companies in the industry for the 14th consecutive year, Herman Miller has qualified for inclusion in RobecoSAM's 2018 Sustainability Yearbook and receives the Silver Class distinction for excellent sustainability performance—economic, environmental, and social.

For the 11th consecutive year, Herman Miller receives a perfect score on the Human Rights Campaign Foundation's Corporate Equality Index and is designated as Best Place to Work for LGBT equality. This report evaluates U.S. companies in terms of diversity, particularly LGBT-related policies and practices.

Contract Information

continued

Herman Miller receives Gold Medal from EcoVadis in recognition of Corporate Social Sustainability achievement measured in categories of environment, labor and human rights, ethics, and sustainable procurement. EcoVadis operates the first web-based collaborative platform that allows companies to assess the environmental and social performance of their global suppliers.

Aeron receives Good Design Award from The Chicago Athenaeum Museum of Architecture and Design.

The Cosm Chair wins Mix Interiors “Product of the Year—Task” award.

2017

Herman Miller receives “Rising Star Award” from the Michigan Veterans Affairs Agency (MVAA) for exhibiting new and novel approaches to veteran recruitment and hiring.

Herman Miller is named the 2017 “Corporation of the Year” in the consumer products sector by the Michigan Minority Supplier Development Council (MMSDC).

Herman Miller receives a 2017 SEAL (Sustainability, Environmental Achievement and Leadership) Business Sustainability Award. SEAL Award winners are determined by a holistic methodology measuring applicants against established benchmarks that demonstrate impact and progress toward creating a healthy planet and a sustainable future.

Herman Miller earns the 4 Star Diversity Visionary Award. This award celebrates the diversity, equality, and inclusion work of Herman Miller. The award is presented at the annual Diversity Equity Inclusion Summit, held by the Grand Rapids Area Chamber of Commerce.

Herman Miller is named one of the Best and Brightest in Wellness for the 5th year in a row.

Herman Miller earns its 10th consecutive perfect score in Human Rights Campaign Foundation’s 2017 Corporate Equality Index.

As one of the top-scoring companies in the industry for the 13th consecutive year, Herman Miller has qualified for inclusion in RobecoSAM’s 2017 Sustainability Yearbook and receives the Bronze Class distinction for excellent economic, environmental, and social sustainability performance. The selection criteria for inclusion in the Yearbook becomes more rigorous each year, and only the top 15 percent of companies within each industry are selected.

Herman Miller once again earns the WorldatWork Seal of Distinction, a unique standard of excellence in work-life effectiveness that shows we provide a distinct, mutually beneficial workplace experience. Herman Miller is the only furniture manufacturer among the 160 companies across the U.S. and Canada honored with the award.

Herman Miller’s Mora wins Nightingale Silver Award in the “Furniture Collections” category at the 2017 Healthcare Design Conference.

2016

Herman Miller earns 9th consecutive perfect score in Human Rights Campaign Foundation’s Corporate Equality Index and is designated as Best Place to Work for LGBT equality.

Herman Miller is recognized as the Business of the Year at the Annual Meeting of the West Michigan Environmental Action Council (WMEAC) for being an outstanding partner in support of the growth of WMEAC’s programs. WMEAC’s award goes to the business with the greatest depth and breadth of support, unwavering dedication to environmental action in West Michigan, and a strong corporate commitment to environmental advocacy.

The 101 Best and Brightest Sustainable Companies once again (5th consecutive year) recognizes Herman Miller as an organization in Michigan (and for the first time, in the nation) that exhibits leadership and innovation in its approach to sustainability. This award celebrates those companies that are making their businesses more sustainable, the lives of their employees better, and the community, both locally and globally, more responsible as a whole.

Herman Miller is recognized by the Michigan Minority Supplier Development Council (MMSDC) as a “Corporation of the Year”. Additionally, we are the only West Michigan company this year to receive an “Ambassadors Championing Excellence” Award from the MMSDC.

Herman Miller is recognized with “2016 Excellence in Supplier Diversity Award” from the Great Lakes Women’s Business Council.

Herman Miller is recognized as a 2016 Healthiest 100 Workplace in America, ranking 49th in the country for our commitment to health and exceptional corporate wellness programming.

Herman Miller receives the Best and Brightest in Wellness Award for the 4th year in a row. This program is an innovative initiative that recognizes and celebrates quality and excellence in health awareness.

The Michigan Occupational Safety and Health Administration renews Herman Miller’s “Star” status, the highest workplace safety and health designation, for the Hickory facility in Spring Lake.

Plex Lounge Furniture from Herman Miller receives #MetropolisLikes award at NeoCon 2016.

Plex Lounge Furniture from Herman Miller receives Interior Design HIP Award for Workplace Seating/Lounge at NeoCon 2016.

Herman Miller is named a 2016 Women on Boards Winning Company. Companies selected for this recognition are considered champions of board diversity as 20 percent or more of their board seats are occupied by women.

Herman Miller is selected for inclusion in the 2016 RobecoSAM Sustainability Yearbook for the 12th consecutive year.

Herman Miller again earns the WorldatWork Work-Life 2016 Seal of Distinction. This award identifies organizations that focus on programs that promote work-life balance and overall well-being.

Contract Information

continued

22b. Section 508 Compliance

Not applicable

23. Unique Entity ID: Q2K3MSZ843D8

24. Registered in System for Award Management (www.SAM.gov) Database

25. Cancellation

Prior to production, no cancellation charge will apply. After production, only actual cost incurred that the contractor can demonstrate if items are sold after 3 months.

26. Restocking Charges

Agencies must notify the contractor for authorization prior to returning any items. The customer agency will be required to pay all packaging and return freight charges. A restocking fee of 50% for Systems Furniture and 35% for all other product lines will be charged for any returned items.

Returns and restocking policy is not applicable to Options products, products under SIN 337127, 339113H, NaughtOne and Nemschoff products.

MillerKnoll Inc. Miscellaneous Information:

Federal ID Number: 38-0837640

Commercial and Government Entity Code (CAGE): 40636

Data Universal Numbering System (DUNS) 00-601-2801

Commercial Entity Code (CEC): 00702290

Introduction	page 2
NaughtOne Seating	3
Lounge Chairs	5
Sofa	20
Stools	29
Booths	30
NaughtOne Tables	35
Coffee Tables	37
Meeting Tables	40
Desks	42
NaughtOne Accessories	45
Indices	49
By Name	49
By Number	51
Appendix-Textiles	

Introduction

A Note on the Organization of This Book

There are a few signals that will help you understand the organization of this book. Once you know them, you should be able to find your way around easily.

Like a newspaper, this book is formatted with columns of text and illustrations that run vertically.

Information wraps from one column to the next and continues for as many pages as it needs to.

Black bars are clues.

A black bar at the top of a page signals the start of information about a product.

This information is divided into two sections, each signaled by a black bar. Product Information includes a description, additional notes, and dimensional drawings. Specification Information, which always begins at the top of a column, includes a series of steps. Each step represents a decision you need to make in order to complete your product number. Steps must be followed sequentially. The number of pages needed to complete information on a product varies; some will be complete in one page; others may fill three or four pages. Just continue going through the steps until you run into the next product, signaled by the black bar at the top of the page.

Black tabs running along the outside edge of the page help you locate what section you are in or what section you want to go to. You can thumb forwards or backwards to find a section; tabs and text appear on both sides of the page.

The additional pages in the back of the book include the appendices and indices. They are signaled by a long black bar running along the outside edge of the page.

The index is presented two ways.

The first index is in alphabetical order by product name. It can be helpful if you are new to the products and numbering scheme or if you are looking for a type of product, such as work chair or round table.

The second index is by product number. It lists, in alphanumeric order, the base product number, typically a five-digit number.

General Information

This book is effective June 3, 2024, subject to change without notice. Products may be purchased from authorized Herman Miller dealers who will quote prices upon request. For more information about our products and services or to see a list of dealers, visit www.HermanMiller.com.

All prices are list prices. Additional services, such as planning services, design, storage, and installation, are not included and must be added to these prices when the additional services are requested.

Illustrations, specifications, and prices are based on the latest information at the time of publication. The right is reserved to make changes at any time without notice in prices, fabrics, finishes, materials, specifications, and models, and also to discontinue models and finishes.

Dimensions shown in the drawings are engineering drawing dimensions rounded up to the nearest $\frac{1}{8}$ ". Product is shipped set up or knocked down. Products that include "Shipped knocked down" in the description require some assembly. If this statement does not appear in the description, the product is shipped assembled.

Service problems are normally handled by a Herman Miller authorized dealer. Where this cannot be accomplished on a local level, service problems should be referred to the Customer Care Representative for your region, Herman Miller, Inc., Zeeland, Michigan 49464.

20-Day or Less/Assigned Lead-Time Shipments

All products and options in this price book not designated by an Assigned Program icon  will ship in **20 business days or less** after being acknowledged by Herman Miller.

Products and options designated by an  are on the assigned lead-time program and may ship in 20 days, less than 20 days, or more than 20 days from order acknowledgement.

Lounge Chairs

Sofa

Stools

Booths



Ever Lounge Chair

NOEVE

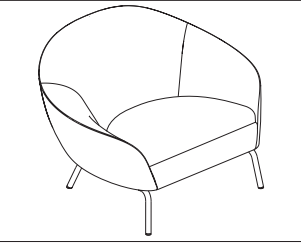

Product Information

Description

This lounge chair is upholstered over an engineered foam core. The foam is slotted over a plywood and steel bracket frame. Legs are available in steel with polyester powder coat or bright chrome finishes, or machined solid wood.

Notes

Nominal dimensions rounded to the nearest 1/2 inch.

Type	Width	Depth	Height	Seat Ht.
10	43 1/2	31 1/2	30	16

Customer's Own Material (COM) requires the following yardage:

Type	Total	Outer	Seat
10xx1	4 1/4	—	—
10xx2	—	3 1/2	1 1/2

Customer's Own Leather (COL) requires the following square feet:

Type	Total	Outer	Seat
10xx1	76 1/2	—	—
10xx2	—	63	27

Dimensions

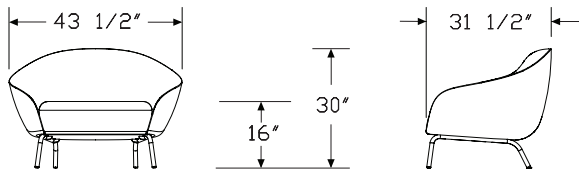

Specification Information

Step 1.

NOEVE

Step 2. Type

10 armchair

Step 3. Base Type

ST steel legs

WD wooden legs

Step 4. Upholstery

1 single fabric

2 multiple fabric

Prices for Steps 1-4.

		1	2
NOEVE 10 ST		\$3591	3591
WD		\$3591	3591

Step 5. Base Finish

For armchair (10) with steel legs (ST)

CHR	chrome <input type="checkbox"/>	+\$86
R00	black RAL 9005 <input type="checkbox"/>	+\$0
R02	stone grey RAL 7030 <input type="checkbox"/>	+\$140
R03	silver - RAL 9006 <input type="checkbox"/>	+\$140
R08	traffic orange RAL 2009 <input type="checkbox"/>	+\$140
R13	pastel blue RAL 5024 <input type="checkbox"/>	+\$140
R14	signal white RAL9003 <input type="checkbox"/>	+\$0
R23	black grey RAL 7021 <input type="checkbox"/>	+\$140
R24	leaf green RAL 6002 <input type="checkbox"/>	+\$140
R25	pale green RAL 6021 <input type="checkbox"/>	+\$140
R28	light pink RAL 3015 <input type="checkbox"/>	+\$140
R29	dark blue RAL 5001 <input type="checkbox"/>	+\$140
R30	oyster RAL 1013 <input type="checkbox"/>	+\$140
R26	RAL 3020 red <input type="checkbox"/>	+\$140
R38	broom yellow RAL 1032 <input type="checkbox"/>	+\$140
R39	moss green RAL 6005 <input type="checkbox"/>	+\$140
R40	steel blue RAL 5011 <input type="checkbox"/>	+\$140

For armchair (10) with wooden legs (WD)

OAK	oak <input type="checkbox"/>	+\$945
WLN	walnut <input type="checkbox"/>	+\$1304

Ever Lounge Chair *continued*

NaughtOne Lounge Chairs

Step 6. Fabric

For armchair (10) with single fabric (1)

Price Category (NaughtOne) 0 <input type="checkbox"/>	+\$0
Price Category (naughtone) 0 <input type="checkbox"/>	+\$0
Price Category (NaughtOne) 1 <input type="checkbox"/>	+\$0
Price Category (naughtone) 1 <input type="checkbox"/>	+\$0
Price Category (NaughtOne) 2 <input type="checkbox"/>	+\$154
Price Category (naughtone) 2 <input type="checkbox"/>	+\$154
Price Category (NaughtOne) 3 <input type="checkbox"/>	+\$308
Price Category (naughtone) 3 <input type="checkbox"/>	+\$308
Price Category (NaughtOne) 4 <input type="checkbox"/>	+\$463
Price Category (naughtone) 4 <input type="checkbox"/>	+\$463
Price Category (NaughtOne) 5 <input type="checkbox"/>	+\$769
Price Category (naughtone) 5 <input type="checkbox"/>	+\$769
Price Category (NaughtOne) 6 <input type="checkbox"/>	+\$1076
Price Category (naughtone) 6 <input type="checkbox"/>	+\$1076
Price Category (NaughtOne) 7 <input type="checkbox"/>	+\$1384
Price Category (naughtone) 7 <input type="checkbox"/>	+\$1384
Price Category (NaughtOne) 9 <input type="checkbox"/>	+\$2000
Price Category (naughtone) 9 <input type="checkbox"/>	+\$2000

Step 7. Outer Fabric

For armchair (10) with multiple fabric (2)

Price Category (NaughtOne) 0 <input type="checkbox"/>	+\$0
Price Category (naughtone) 0 <input type="checkbox"/>	+\$0
Price Category (NaughtOne) 1 <input type="checkbox"/>	+\$0
Price Category (naughtone) 1 <input type="checkbox"/>	+\$0
Price Category (NaughtOne) 2 <input type="checkbox"/>	+\$103
Price Category (naughtone) 2 <input type="checkbox"/>	+\$103
Price Category (NaughtOne) 3 <input type="checkbox"/>	+\$205
Price Category (naughtone) 3 <input type="checkbox"/>	+\$205
Price Category (NaughtOne) 4 <input type="checkbox"/>	+\$309
Price Category (naughtone) 4 <input type="checkbox"/>	+\$309
Price Category (NaughtOne) 5 <input type="checkbox"/>	+\$513
Price Category (naughtone) 5 <input type="checkbox"/>	+\$513
Price Category (NaughtOne) 6 <input type="checkbox"/>	+\$718
Price Category (naughtone) 6 <input type="checkbox"/>	+\$718
Price Category (NaughtOne) 7 <input type="checkbox"/>	+\$922
Price Category (naughtone) 7 <input type="checkbox"/>	+\$922
Price Category (NaughtOne) 9 <input type="checkbox"/>	+\$1333
Price Category (naughtone) 9 <input type="checkbox"/>	+\$1333

Step 8. Seat Fabric

For armchair (10) with multiple fabric (2)

Price Category (NaughtOne) 0 <input type="checkbox"/>	+\$0
Price Category (naughtone) 0 <input type="checkbox"/>	+\$0
Price Category (NaughtOne) 1 <input type="checkbox"/>	+\$0
Price Category (naughtone) 1 <input type="checkbox"/>	+\$0
Price Category (NaughtOne) 2 <input type="checkbox"/>	+\$51
Price Category (naughtone) 2 <input type="checkbox"/>	+\$51
Price Category (NaughtOne) 3 <input type="checkbox"/>	+\$103
Price Category (naughtone) 3 <input type="checkbox"/>	+\$103
Price Category (NaughtOne) 4 <input type="checkbox"/>	+\$154
Price Category (naughtone) 4 <input type="checkbox"/>	+\$154
Price Category (NaughtOne) 5 <input type="checkbox"/>	+\$256
Price Category (naughtone) 5 <input type="checkbox"/>	+\$256
Price Category (NaughtOne) 6 <input type="checkbox"/>	+\$359
Price Category (naughtone) 6 <input type="checkbox"/>	+\$359
Price Category (NaughtOne) 7 <input type="checkbox"/>	+\$462
Price Category (naughtone) 7 <input type="checkbox"/>	+\$462
Price Category (NaughtOne) 9 <input type="checkbox"/>	+\$667
Price Category (naughtone) 9 <input type="checkbox"/>	+\$667

Percy Lounge Chair

NOPRC

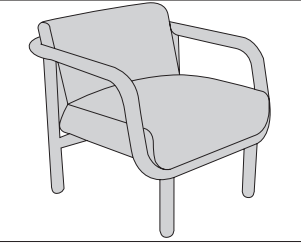

Product Information

Description

This lounge chair is upholstered over a plywood inner structure and high-quality foam. The frame is constructed from laser-cut, machine-bent and welded steel tube finished in a hard-wearing polyester powder coat.

Notes

Nominal dimensions rounded to the nearest 1/2 inch.

Type	Width	Depth	Height	Seat Ht.
10	27 1/2	30	28 1/2	17 1/2

Customer's Own Material (COM) requires the following yardage:

Type	Total
10	2 1/2

Customer's Own Leather (COL) requires the following square feet:

Type	Total
10	40

Dimensions

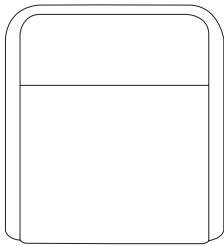

27 1/2"

30"

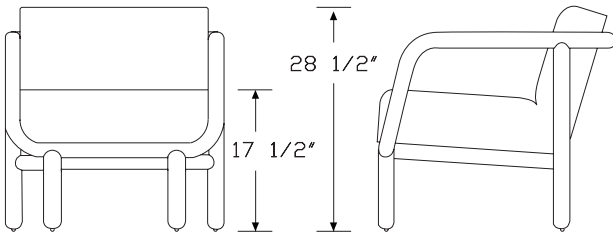

28 1/2"

17 1/2"

Specification Information

Step 1.

NOPRC

Step 2. Type

10 lounge chair

Prices for Steps 1-2.

NOPRC 10 \$3469

Step 3. Frame Finish

R00	black RAL 9005 <input type="checkbox"/>	+\$0
R14	signal white RAL9003 <input type="checkbox"/>	+\$0
R02	stone grey RAL 7030 <input type="checkbox"/>	+\$200
R03	silver - RAL 9006 <input type="checkbox"/>	+\$200
R08	traffic orange RAL 2009 <input type="checkbox"/>	+\$200
R13	pastel blue RAL 5024 <input type="checkbox"/>	+\$200
R23	black grey RAL 7021 <input type="checkbox"/>	+\$200
R24	leaf green RAL 6002 <input type="checkbox"/>	+\$200
R25	pale green RAL 6021 <input type="checkbox"/>	+\$200
R26	traffic red RAL 3020 <input type="checkbox"/>	+\$200
R28	light pink RAL 3015 <input type="checkbox"/>	+\$200
R29	dark blue RAL 5001 <input type="checkbox"/>	+\$200
R30	oyster RAL 1013 <input type="checkbox"/>	+\$200
R38	broom yellow RAL 1032 <input type="checkbox"/>	+\$200
R39	moss green RAL 6005 <input type="checkbox"/>	+\$200
R40	steel blue RAL 5011 <input type="checkbox"/>	+\$200

Percy Lounge Chair *continued*

NaughtOne Lounge Chairs

Step 4. Fabric	
A	+\$0
Price Category (NaughtOne) 1 A	+\$0
Price Category (naughtone) 1 A	+\$0
Price Category (NaughtOne) 2 A	+\$143
Price Category (naughtone) 2 A	+\$143
Price Category (NaughtOne) 3 A	+\$286
Price Category (naughtone) 3 A	+\$286
Price Category (NaughtOne) 4 A	+\$429
Price Category (naughtone) 4 A	+\$429
Price Category (NaughtOne) 5 A	+\$715
Price Category (naughtone) 5 A	+\$715
Price Category (NaughtOne) 6 A	+\$1001
Price Category (naughtone) 6 A	+\$1001
Price Category (NaughtOne) 7 A	+\$1287
Price Category (naughtone) 7 A	+\$1287
Price Category (NaughtOne) 8 A	+\$1573
Price Category (naughtone) 8 A	+\$1573
Price Category (NaughtOne) 9 A	+\$1859
Price Category (naughtone) 9 A	+\$1859

Pippin Lounge Chair

NOPIP

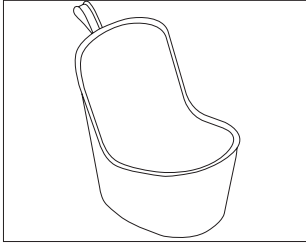

Product Information

Description

This lounge chair is upholstered over an engineered foam core. The textile cover is removable, and the foam is slotted over a plywood frame. Product is available with glides and with or without a TPU strap handle.

Notes

Nominal dimensions rounded to the nearest 1/2 inch.

Type	Width	Depth	Height	Seat Ht.
10	21	30	30	15 1/2

Customer's Own Material (COM) requires the following yardage:

Type	Total
10	2 1/2

Customer's Own Leather (COL) requires the following square feet:

Type	Total
10	40

Dimensions

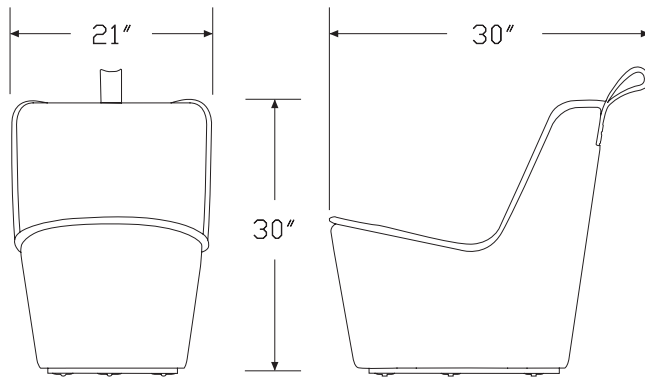

Specification Information

Step 1.

NOPIP

Step 2. Type

10 lounge chair

Step 3. Base Type

GL glides

Step 4. Strap Handle

N no strap handle

H strap handle

Prices for Steps 1-4.

	N	H
NOPIP 10 GL	\$2400	2450

Step 5. Handle Finish

For no strap handle (N)

N no selection +\$0

For strap handle (H)

R08 traffic orange RAL 2009 +\$0

R13 pastel blue RAL 5024 +\$0

R23 black grey RAL 7021 +\$0

R25 pale green RAL 6021 +\$0

R28 light pink RAL 3015 +\$0

R30 oyster RAL 1013 +\$0

Pippin Lounge Chair *continued*

NaughtOne Lounge Chairs

Step 6. Fabric	
Price Category (NaughtOne) 0	<input type="checkbox"/> A +\$0
Price Category (naughtone) 0	<input type="checkbox"/> A +\$0
Price Category (NaughtOne) 1	<input type="checkbox"/> A +\$0
Price Category (naughtone) 1	<input type="checkbox"/> A +\$0
Price Category (NaughtOne) 2	<input type="checkbox"/> A +\$130
Price Category (naughtone) 2	<input type="checkbox"/> A +\$130
Price Category (NaughtOne) 3	<input type="checkbox"/> A +\$260
Price Category (naughtone) 3	<input type="checkbox"/> A +\$260
Price Category (NaughtOne) 4	<input type="checkbox"/> A +\$390
Price Category (naughtone) 4	<input type="checkbox"/> A +\$390
Price Category (NaughtOne) 5	<input type="checkbox"/> A +\$650
Price Category (naughtone) 5	<input type="checkbox"/> A +\$650
Price Category (NaughtOne) 6	<input type="checkbox"/> A +\$910
Price Category (naughtone) 6	<input type="checkbox"/> A +\$910
Price Category (NaughtOne) 7	<input type="checkbox"/> A +\$1170
Price Category (naughtone) 7	<input type="checkbox"/> A +\$1170

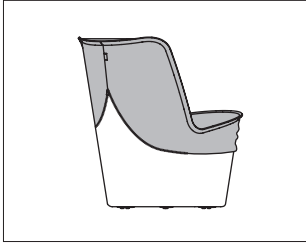

Product Information

Description

This replacement textile cover for the Pippin Lounge Chair can be used with or without a Pippin strap handle, ordered separately. Replacement instructions included.

Notes

Replacement textile cover for Pippin Lounge Chair (NOPIP10).

For guidance on how to correctly recover the product, see Pippin

Replacement Instructions provided with cover.

Customer's Own Material (COM) requires 2½ yards.

Customer's Own Leather (COL) requires 40 square feet:

Specification Information

Step 1.

NOPIP

Step 2. Type

CV Replacement cover

Prices for Steps 1-2.

NOPIP CV \$900

Step 3. Fabric

Price Category (NaughtOne) 0	<input type="checkbox"/>	+\$0
Price Category (naughtone) 0	<input type="checkbox"/>	+\$0
Price Category (NaughtOne) 1	<input type="checkbox"/>	+\$0
Price Category (naughtone) 1	<input type="checkbox"/>	+\$0
Price Category (NaughtOne) 2	<input type="checkbox"/>	+\$130
Price Category (naughtone) 2	<input type="checkbox"/>	+\$130
Price Category (NaughtOne) 3	<input type="checkbox"/>	+\$260
Price Category (naughtone) 3	<input type="checkbox"/>	+\$260
Price Category (NaughtOne) 4	<input type="checkbox"/>	+\$390
Price Category (naughtone) 4	<input type="checkbox"/>	+\$390
Price Category (NaughtOne) 5	<input type="checkbox"/>	+\$650
Price Category (naughtone) 5	<input type="checkbox"/>	+\$650
Price Category (NaughtOne) 6	<input type="checkbox"/>	+\$910
Price Category (naughtone) 6	<input type="checkbox"/>	+\$910
Price Category (NaughtOne) 7	<input type="checkbox"/>	+\$1170
Price Category (naughtone) 7	<input type="checkbox"/>	+\$1170

Pippin Replacement Strap Handle

NOPIP

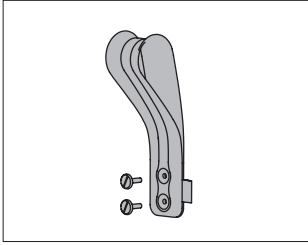

NaughtOne Lounge Chairs

Product Information

Description

This molded TPU replacement strap handle for the Pippin Lounge Chair can replace an existing strap handle or be added to an existing Pippin lounge chair. Required fasteners and replacement instructions included.

Notes

Replacement strap handle for Pippin Lounge Chair (NOPIP10).

Replacement strap handle can be added to a Pippin lounge chair that does not currently have a strap handle with no damage to the textile cover.

For guidance on how to correctly replace or add the strap handle, see Pippin Replacement Instructions provided with strap handle.

Dimensions

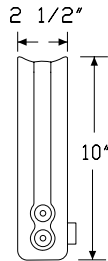

Specification Information

Step 1.

NOPIP

Step 2. Type

SH Replacement strap handle

Prices for Steps 1-2.

NOPIP SH \$80

Step 3. Handle Finish

R08	traffic orange RAL 2009 <input type="checkbox"/>	+\$0
R13	pastel blue RAL 5024 <input type="checkbox"/>	+\$0
R23	black grey RAL 7021 <input type="checkbox"/>	+\$0
R25	pale green RAL 6021 <input type="checkbox"/>	+\$0
R28	light pink RAL 3015 <input type="checkbox"/>	+\$0
R30	oyster RAL 1013 <input type="checkbox"/>	+\$0

Pullman Chair

NOPUL

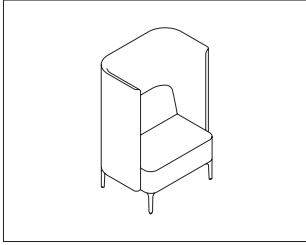

Product Information

Description

The Pullman chair is upholstered over a plywood inner frame topped with high quality foams. Pullman can be upholstered in a single fabric or multiple fabrics. Legs are laser cut folded mild steel and solid wood. Chair can be specified with swivel or non-swivel plinth base.

Notes

Customer's Own Material (COM) requires the following yardage:

Type	Total	Inner & Seat	Outer
4	9	3	6
5	11	5	6
6	11	5	6

Customer's Own Leather (COL) requires the following square feet:

Type	Total	Inner & Seat	Outer
4	144	48	96
5	176	80	96
6	176	80	96

Dimensions

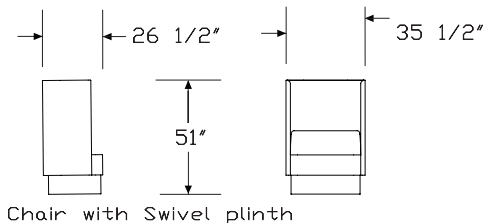
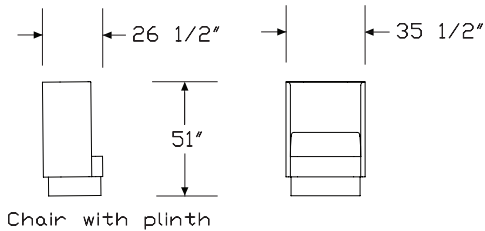
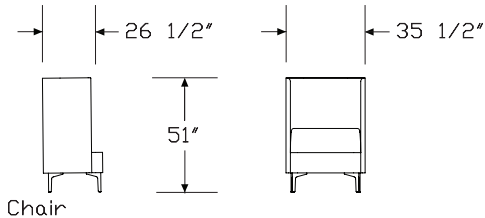

Specification Information

Step 1.

NOPUL

Step 2. Type

- 4 chair
- 5 chair with plinth
- 6 chair with swivel plinth

Step 3. Upholstery

- 1 single fabric
- 2 multiple fabric

Step 4. Power Access Cut-out

For chair (4) or chair with plinth (5)

- OCS** no cut-out system
- WNDR** with node cut-out system (right hand side)

For chair with swivel plinth (6)

- OCS** no cut-out system

Step 5. Tablet Arm Option

For chair (4), chair with plinth (5), or chair with swivel plinth (6)

- 00** no tablet arm

Prices for Steps 1-5.

		OCS00	WNDR00
NOPUL	4	1	\$6964 7426
		2	\$6964 7426
5	1	1	\$7829 8292
		2	\$7829 8292
	6	1	\$8364 —
		2	\$8364 —

Step 6. Base Finish

For chair (4)

R00	RAL 9005 black <input type="checkbox"/>	+\$0
R02	RAL 7030 stone grey <input type="checkbox"/>	+\$177
R03	RAL 9006 silver <input type="checkbox"/>	+\$177
R08	RAL 2009 orange <input type="checkbox"/>	+\$177
R13	RAL 5024 pastel blue <input type="checkbox"/>	+\$177
R14	RAL 9003 white <input type="checkbox"/>	+\$0
R23	RAL 7021 black grey <input type="checkbox"/>	+\$177
R24	leaf green RAL 6002 <input type="checkbox"/>	+\$177
R25	RAL 6021 green <input type="checkbox"/>	+\$177
R26	RAL 3020 red <input type="checkbox"/>	+\$177
R28	RAL 3015 light pink <input type="checkbox"/>	+\$177
R29	RAL 5001 blue <input type="checkbox"/>	+\$177
R30	RAL 1013 oyster <input type="checkbox"/>	+\$177
R38	broom yellow RAL 1032 <input type="checkbox"/>	+\$177
R39	moss green RAL 6005 <input type="checkbox"/>	+\$177
R40	steel blue RAL 5011 <input type="checkbox"/>	+\$177
OAK	oak <input type="checkbox"/>	+\$714
WLN	walnut <input type="checkbox"/>	+\$1243

Step 7. Fabric

For chair (4) with single fabric (1)

Price Category (NaughtOne) 1 <input type="checkbox"/>	+\$0
Price Category (naughtone) 1 <input type="checkbox"/>	+\$0
Price Category (NaughtOne) 2 <input type="checkbox"/>	+\$240
Price Category (naughtone) 2 <input type="checkbox"/>	+\$240
Price Category (NaughtOne) 3 <input type="checkbox"/>	+\$480
Price Category (naughtone) 3 <input type="checkbox"/>	+\$480
Price Category (NaughtOne) 4 <input type="checkbox"/>	+\$719
Price Category (naughtone) 4 <input type="checkbox"/>	+\$719
Price Category (NaughtOne) 5 <input type="checkbox"/>	+\$1199
Price Category (naughtone) 5 <input type="checkbox"/>	+\$1199
Price Category (NaughtOne) 6 <input type="checkbox"/>	+\$1678
Price Category (naughtone) 6 <input type="checkbox"/>	+\$1678
Price Category (NaughtOne) 7 <input type="checkbox"/>	+\$2158
Price Category (naughtone) 7 <input type="checkbox"/>	+\$2158

For chair with plinth (5) or chair with swivel plinth (6) with single fabric (1)

Price Category (NaughtOne) 1 <input type="checkbox"/>	+\$0
Price Category (naughtone) 1 <input type="checkbox"/>	+\$0
Price Category (NaughtOne) 2 <input type="checkbox"/>	+\$254
Price Category (naughtone) 2 <input type="checkbox"/>	+\$254
Price Category (NaughtOne) 3 <input type="checkbox"/>	+\$505
Price Category (naughtone) 3 <input type="checkbox"/>	+\$505
Price Category (NaughtOne) 4 <input type="checkbox"/>	+\$759
Price Category (naughtone) 4 <input type="checkbox"/>	+\$759
Price Category (NaughtOne) 5 <input type="checkbox"/>	+\$1265
Price Category (naughtone) 5 <input type="checkbox"/>	+\$1265
Price Category (NaughtOne) 6 <input type="checkbox"/>	+\$1771
Price Category (naughtone) 6 <input type="checkbox"/>	+\$1771
Price Category (NaughtOne) 7 <input type="checkbox"/>	+\$2277
Price Category (naughtone) 7 <input type="checkbox"/>	+\$2277

Step 8. Seat and Backrest Fabric

For chair (4) with multiple fabric (2)

Price Category (NaughtOne) 0 <input type="checkbox"/>	+\$0
Price Category (naughtone) 0 <input type="checkbox"/>	+\$0
Price Category (NaughtOne) 1 <input type="checkbox"/>	+\$0
Price Category (naughtone) 1 <input type="checkbox"/>	+\$0
Price Category (NaughtOne) 2 <input type="checkbox"/>	+\$66
Price Category (naughtone) 2 <input type="checkbox"/>	+\$66
Price Category (NaughtOne) 3 <input type="checkbox"/>	+\$131
Price Category (naughtone) 3 <input type="checkbox"/>	+\$131
Price Category (NaughtOne) 4 <input type="checkbox"/>	+\$198
Price Category (naughtone) 4 <input type="checkbox"/>	+\$198
Price Category (NaughtOne) 5 <input type="checkbox"/>	+\$331
Price Category (naughtone) 5 <input type="checkbox"/>	+\$331
Price Category (NaughtOne) 6 <input type="checkbox"/>	+\$463
Price Category (naughtone) 6 <input type="checkbox"/>	+\$463
Price Category (NaughtOne) 7 <input type="checkbox"/>	+\$594
Price Category (naughtone) 7 <input type="checkbox"/>	+\$594
Price Category (NaughtOne) 9 <input type="checkbox"/>	+\$857
Price Category (naughtone) 9 <input type="checkbox"/>	+\$857

For chair with plinth (5) or chair with swivel plinth (6) with multiple fabric (2)

Price Category (NaughtOne) 0	A	+\$0
Price Category (naughtone) 0	A	+\$0
Price Category (NaughtOne) 1	A	+\$0
Price Category (naughtone) 1	A	+\$0
Price Category (NaughtOne) 2	A	+\$71
Price Category (naughtone) 2	A	+\$71
Price Category (NaughtOne) 3	A	+\$138
Price Category (naughtone) 3	A	+\$138
Price Category (NaughtOne) 4	A	+\$209
Price Category (naughtone) 4	A	+\$209
Price Category (NaughtOne) 5	A	+\$349
Price Category (naughtone) 5	A	+\$349
Price Category (NaughtOne) 6	A	+\$488
Price Category (naughtone) 6	A	+\$488
Price Category (NaughtOne) 7	A	+\$626
Price Category (naughtone) 7	A	+\$626
Price Category (NaughtOne) 9	A	+\$905
Price Category (naughtone) 9	A	+\$905

Step 9. Outer Fabric

For chair (4) with multiple fabric (2)

Price Category (NaughtOne) 0	A	+\$0
Price Category (naughtone) 0	A	+\$0
Price Category (NaughtOne) 1	A	+\$0
Price Category (naughtone) 1	A	+\$0
Price Category (NaughtOne) 2	A	+\$175
Price Category (naughtone) 2	A	+\$175
Price Category (NaughtOne) 3	A	+\$349
Price Category (naughtone) 3	A	+\$349
Price Category (NaughtOne) 4	A	+\$521
Price Category (naughtone) 4	A	+\$521
Price Category (NaughtOne) 5	A	+\$868
Price Category (naughtone) 5	A	+\$868
Price Category (NaughtOne) 6	A	+\$1215
Price Category (naughtone) 6	A	+\$1215
Price Category (NaughtOne) 7	A	+\$1564
Price Category (naughtone) 7	A	+\$1564
Price Category (NaughtOne) 9	A	+\$2260
Price Category (naughtone) 9	A	+\$2260

For chair with plinth (5) or chair with swivel plinth (6) with multiple fabric (2)

Price Category (NaughtOne) 0	A	+\$0
Price Category (naughtone) 0	A	+\$0
Price Category (NaughtOne) 1	A	+\$0
Price Category (naughtone) 1	A	+\$0
Price Category (NaughtOne) 2	A	+\$184
Price Category (naughtone) 2	A	+\$184
Price Category (NaughtOne) 3	A	+\$367
Price Category (naughtone) 3	A	+\$367
Price Category (NaughtOne) 4	A	+\$551
Price Category (naughtone) 4	A	+\$551
Price Category (NaughtOne) 5	A	+\$916
Price Category (naughtone) 5	A	+\$916
Price Category (NaughtOne) 6	A	+\$1283
Price Category (naughtone) 6	A	+\$1283
Price Category (NaughtOne) 7	A	+\$1650
Price Category (naughtone) 7	A	+\$1650
Price Category (NaughtOne) 9	A	+\$2385
Price Category (naughtone) 9	A	+\$2385

Step 10. Power Option

For chair (4) or chair with plinth (5) with with node cut-out system (right hand side) (WNDR)

ND1W	node power unit with 1x power and 2x USB in white	A	+\$365
ND1B	node power unit with 1x power and 2x USB in black	A	+\$365
ND2W	node power unit with 2x power in white	A	+\$298
ND2B	node power unit with 2x power in black	A	+\$298

Pullman Chair Pod

NOPUL

NaughtOne Lounge Chairs

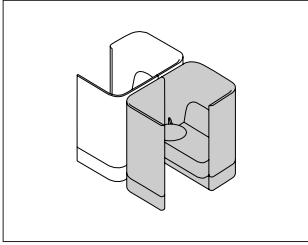

Product Information

Description
 The Pullman chair pod is upholstered over a plywood inner frame topped with high quality foams. Pullman can be upholstered in a single fabric or multiple fabrics. Legs are laser cut folded mild steel and solid wood. Chair pod can also be specified with an upholstered plinth base.

Notes

Nominal dimensions rounded to the nearest 1/2 inch.

Type	Width	Depth	Height	Seat Height
P4L	35 1/2	51	51	18
P4R	35 1/2	51	51	18
P5L	35 1/2	51	51	18
P5R	35 1/2	51	51	18

Customer's Own Material (COM) requires the following yardage:

Type	Total	Seat/Backrest	Outer (Upper)	Plinth
P4L	13.2	3	10.2	-
P4R	13.2	3	10.2	-
P5L	14.85	3	9.75	2.1
P5R	14.85	3	9.75	2.1

Specification Information

Step 1.

NOPUL

Step 2. Type

- P4L** chair pod on legs - screen left
- P4R** chair pod on legs - screen right
- P5L** chair pod on plinth - screen left
- P5R** chair pod on plinth - screen right

Step 3. Upholstery

For chair pod on legs - screen left (P4L) or chair pod on legs - screen right (P4R)

- 1** single fabric
- 2** multiple fabrics (seat and backrest / outer)

For chair pod on plinth - screen left (P5L) or chair pod on plinth - screen right (P5R)

- 1** single fabric
- 2** multiple fabrics (seat and backrest / outer)
- 3** multiple fabrics (seat, backrest and upper outer / plinth)

Step 4. Power Access Cut-out

- OCS** no cut-out system
- WND** with node cut-out system (same side of chair as screen)

Step 5. Tablet Arm Option

- 00** no tablet arm

Prices for Steps 1-5.

	OCS00	WND00
NOPUL P4L 1	\$7767	8208
2	\$7767	8208
P4R 1	\$7767	8208
2	\$7767	8208
P5L 1	\$8177	8618
2	\$8177	8618
3	\$8177	8618
P5R 1	\$8177	8618
2	\$8177	8618
3	\$8177	8618

Step 6. Base Finish

For chair pod on legs - screen left (P4L) or chair pod on legs - screen right (P4R)

R00	RAL 9005 black <input type="checkbox"/>	+\$0
R02	RAL 7030 stone grey <input type="checkbox"/>	+\$264
R03	RAL 9006 silver <input type="checkbox"/>	+\$264
R08	RAL 2009 orange <input type="checkbox"/>	+\$264
R13	RAL 5024 pastel blue <input type="checkbox"/>	+\$264
R14	RAL 9003 white <input type="checkbox"/>	+\$0
R23	RAL 7021 black grey <input type="checkbox"/>	+\$264
R24	RAL 6002 leaf green <input type="checkbox"/>	+\$264
R25	RAL 6021 green <input type="checkbox"/>	+\$264
R26	RAL 3020 red <input type="checkbox"/>	+\$264
R28	RAL 3015 light pink <input type="checkbox"/>	+\$264
R29	RAL 5001 blue <input type="checkbox"/>	+\$264
R30	RAL 1013 oyster <input type="checkbox"/>	+\$264
R38	broom yellow RAL 1032 <input type="checkbox"/>	+\$264
R39	moss green RAL 6005 <input type="checkbox"/>	+\$264
R40	steel blue RAL 5011 <input type="checkbox"/>	+\$264
OAK	oak <input type="checkbox"/>	+\$846
WLN	walnut <input type="checkbox"/>	+\$1642

Step 7. Fabric

For chair pod on legs - screen left (P4L) or chair pod on legs - screen right (P4R) with single fabric (1)

Price Category (NaughtOne) 0 <input type="checkbox"/>	+\$0
Price Category (naughtone) 0 <input type="checkbox"/>	+\$0
Price Category (NaughtOne) 1 <input type="checkbox"/>	+\$0
Price Category (naughtone) 1 <input type="checkbox"/>	+\$0
Price Category (NaughtOne) 2 <input type="checkbox"/>	+\$441
Price Category (naughtone) 2 <input type="checkbox"/>	+\$441
Price Category (NaughtOne) 3 <input type="checkbox"/>	+\$883
Price Category (naughtone) 3 <input type="checkbox"/>	+\$883
Price Category (NaughtOne) 4 <input type="checkbox"/>	+\$1326
Price Category (naughtone) 4 <input type="checkbox"/>	+\$1326
Price Category (NaughtOne) 5 <input type="checkbox"/>	+\$2209
Price Category (naughtone) 5 <input type="checkbox"/>	+\$2209
Price Category (NaughtOne) 6 <input type="checkbox"/>	+\$3093
Price Category (naughtone) 6 <input type="checkbox"/>	+\$3093
Price Category (NaughtOne) 7 <input type="checkbox"/>	+\$3977
Price Category (naughtone) 7 <input type="checkbox"/>	+\$3977
Price Category (NaughtOne) 9 <input type="checkbox"/>	+\$5745
Price Category (naughtone) 9 <input type="checkbox"/>	+\$5745

For chair pod on plinth - screen left (P5L) or chair pod on plinth - screen right (P5R) with single fabric (1)

Price Category (NaughtOne) 0 <input type="checkbox"/>	+\$0
Price Category (naughtone) 0 <input type="checkbox"/>	+\$0
Price Category (NaughtOne) 1 <input type="checkbox"/>	+\$0
Price Category (naughtone) 1 <input type="checkbox"/>	+\$0
Price Category (NaughtOne) 2 <input type="checkbox"/>	+\$515
Price Category (naughtone) 2 <input type="checkbox"/>	+\$515
Price Category (NaughtOne) 3 <input type="checkbox"/>	+\$1030
Price Category (naughtone) 3 <input type="checkbox"/>	+\$1030
Price Category (NaughtOne) 4 <input type="checkbox"/>	+\$1544
Price Category (naughtone) 4 <input type="checkbox"/>	+\$1544
Price Category (NaughtOne) 5 <input type="checkbox"/>	+\$2574
Price Category (naughtone) 5 <input type="checkbox"/>	+\$2574
Price Category (NaughtOne) 6 <input type="checkbox"/>	+\$3602
Price Category (naughtone) 6 <input type="checkbox"/>	+\$3602
Price Category (NaughtOne) 7 <input type="checkbox"/>	+\$4629
Price Category (naughtone) 7 <input type="checkbox"/>	+\$4629
Price Category (NaughtOne) 9 <input type="checkbox"/>	+\$6684
Price Category (naughtone) 9 <input type="checkbox"/>	+\$6684

Step 8. Seat and Backrest Fabric

For chair pod on legs - screen left (P4L) or chair pod on legs - screen right (P4R) with multiple fabrics (seat and backrest / outer) (2)

Price Category (NaughtOne) 0 <input type="checkbox"/>	+\$0
Price Category (naughtone) 0 <input type="checkbox"/>	+\$0
Price Category (NaughtOne) 1 <input type="checkbox"/>	+\$0
Price Category (naughtone) 1 <input type="checkbox"/>	+\$0
Price Category (NaughtOne) 2 <input type="checkbox"/>	+\$88
Price Category (naughtone) 2 <input type="checkbox"/>	+\$88
Price Category (NaughtOne) 3 <input type="checkbox"/>	+\$177
Price Category (naughtone) 3 <input type="checkbox"/>	+\$177
Price Category (NaughtOne) 4 <input type="checkbox"/>	+\$265
Price Category (naughtone) 4 <input type="checkbox"/>	+\$265
Price Category (NaughtOne) 5 <input type="checkbox"/>	+\$442
Price Category (naughtone) 5 <input type="checkbox"/>	+\$442
Price Category (NaughtOne) 6 <input type="checkbox"/>	+\$619
Price Category (naughtone) 6 <input type="checkbox"/>	+\$619
Price Category (NaughtOne) 7 <input type="checkbox"/>	+\$796
Price Category (naughtone) 7 <input type="checkbox"/>	+\$796
Price Category (NaughtOne) 9 <input type="checkbox"/>	+\$1149
Price Category (naughtone) 9 <input type="checkbox"/>	+\$1149

For chair pod on plinth - screen left (P5L) or chair pod on plinth - screen right (P5R) with multiple fabrics (seat and backrest / outer) (2)

Price Category (NaughtOne) 0	A	+\$0
Price Category (naughtone) 0	A	+\$0
Price Category (NaughtOne) 1	A	+\$0
Price Category (naughtone) 1	A	+\$0
Price Category (NaughtOne) 2	A	+\$88
Price Category (naughtone) 2	A	+\$88
Price Category (NaughtOne) 3	A	+\$179
Price Category (naughtone) 3	A	+\$179
Price Category (NaughtOne) 4	A	+\$268
Price Category (naughtone) 4	A	+\$268
Price Category (NaughtOne) 5	A	+\$446
Price Category (naughtone) 5	A	+\$446
Price Category (NaughtOne) 6	A	+\$625
Price Category (naughtone) 6	A	+\$625
Price Category (NaughtOne) 7	A	+\$803
Price Category (naughtone) 7	A	+\$803
Price Category (NaughtOne) 9	A	+\$1160
Price Category (naughtone) 9	A	+\$1160

Step 9. Outer Fabric

For chair pod on legs - screen left (P4L) or chair pod on legs - screen right (P4R) with multiple fabrics (seat and backrest / outer) (2)

Price Category (NaughtOne) 0	A	+\$0
Price Category (naughtone) 0	A	+\$0
Price Category (NaughtOne) 1	A	+\$0
Price Category (naughtone) 1	A	+\$0
Price Category (NaughtOne) 2	A	+\$353
Price Category (naughtone) 2	A	+\$353
Price Category (NaughtOne) 3	A	+\$706
Price Category (naughtone) 3	A	+\$706
Price Category (NaughtOne) 4	A	+\$1061
Price Category (naughtone) 4	A	+\$1061
Price Category (NaughtOne) 5	A	+\$1767
Price Category (naughtone) 5	A	+\$1767
Price Category (NaughtOne) 6	A	+\$2474
Price Category (naughtone) 6	A	+\$2474
Price Category (NaughtOne) 7	A	+\$3181
Price Category (naughtone) 7	A	+\$3181
Price Category (NaughtOne) 9	A	+\$4596
Price Category (naughtone) 9	A	+\$4596

For chair pod on plinth - screen left (P5L) or chair pod on plinth - screen right (P5R) with multiple fabrics (seat and backrest / outer) (2)

Price Category (NaughtOne) 0	A	+\$0
Price Category (naughtone) 0	A	+\$0
Price Category (NaughtOne) 1	A	+\$0
Price Category (naughtone) 1	A	+\$0
Price Category (NaughtOne) 2	A	+\$425
Price Category (naughtone) 2	A	+\$425
Price Category (NaughtOne) 3	A	+\$851
Price Category (naughtone) 3	A	+\$851
Price Category (NaughtOne) 4	A	+\$1276
Price Category (naughtone) 4	A	+\$1276
Price Category (NaughtOne) 5	A	+\$2128
Price Category (naughtone) 5	A	+\$2128
Price Category (NaughtOne) 6	A	+\$2976
Price Category (naughtone) 6	A	+\$2976
Price Category (NaughtOne) 7	A	+\$3826
Price Category (naughtone) 7	A	+\$3826
Price Category (NaughtOne) 9	A	+\$5524
Price Category (naughtone) 9	A	+\$5524

Step 10. Seat, Backrest and Upper Outer Fabric

For chair pod on plinth - screen left (P5L) or chair pod on plinth - screen right (P5R) with multiple fabrics (seat, backrest and upper outer / plinth) (3)

Price Category (NaughtOne) 0	A	+\$0
Price Category (naughtone) 0	A	+\$0
Price Category (NaughtOne) 1	A	+\$0
Price Category (naughtone) 1	A	+\$0
Price Category (NaughtOne) 2	A	+\$442
Price Category (naughtone) 2	A	+\$442
Price Category (NaughtOne) 3	A	+\$884
Price Category (naughtone) 3	A	+\$884
Price Category (NaughtOne) 4	A	+\$1326
Price Category (naughtone) 4	A	+\$1326
Price Category (NaughtOne) 5	A	+\$2210
Price Category (naughtone) 5	A	+\$2210
Price Category (NaughtOne) 6	A	+\$3092
Price Category (naughtone) 6	A	+\$3092
Price Category (NaughtOne) 7	A	+\$3975
Price Category (naughtone) 7	A	+\$3975
Price Category (NaughtOne) 9	A	+\$5739
Price Category (naughtone) 9	A	+\$5739

Step 11. Plinth Fabric

For chair pod on plinth - screen left (P5L) or chair pod on plinth - screen right (P5R) with multiple fabrics (seat, backrest and upper outer / plinth) (3)

Price Category (NaughtOne) 0	<input type="checkbox"/> A	+\$0
Price Category (naughtone) 0	<input type="checkbox"/> A	+\$0
Price Category (NaughtOne) 1	<input type="checkbox"/> A	+\$0
Price Category (naughtone) 1	<input type="checkbox"/> A	+\$0
Price Category (NaughtOne) 2	<input type="checkbox"/> A	+\$73
Price Category (naughtone) 2	<input type="checkbox"/> A	+\$73
Price Category (NaughtOne) 3	<input type="checkbox"/> A	+\$146
Price Category (naughtone) 3	<input type="checkbox"/> A	+\$146
Price Category (NaughtOne) 4	<input type="checkbox"/> A	+\$218
Price Category (naughtone) 4	<input type="checkbox"/> A	+\$218
Price Category (NaughtOne) 5	<input type="checkbox"/> A	+\$364
Price Category (naughtone) 5	<input type="checkbox"/> A	+\$364
Price Category (NaughtOne) 6	<input type="checkbox"/> A	+\$510
Price Category (naughtone) 6	<input type="checkbox"/> A	+\$510
Price Category (NaughtOne) 7	<input type="checkbox"/> A	+\$654
Price Category (naughtone) 7	<input type="checkbox"/> A	+\$654
Price Category (NaughtOne) 9	<input type="checkbox"/> A	+\$945
Price Category (naughtone) 9	<input type="checkbox"/> A	+\$945

Step 12. Power Option

For chair pod on legs - screen left (P4L), chair pod on legs - screen right (P4R), chair pod on plinth - screen left (P5L), or chair pod on plinth - screen right (P5R) with with node cut-out system (same side of chair as screen) (WND)

ND1B	node power unit with 1x power and 2x USB in black	<input type="checkbox"/> A	+\$365
ND1W	node power unit with 1x power and 2x USB in white	<input type="checkbox"/> A	+\$365
ND2B	node power unit with 2x power in black	<input type="checkbox"/> A	+\$298
ND2W	node power unit with 2x power in white	<input type="checkbox"/> A	+\$298

Ever Sofa

NOEVE

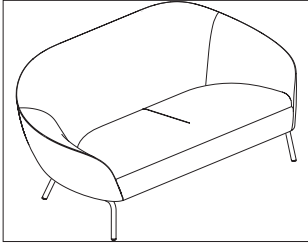

NaughtOne Sofa

Product Information

Description

This sofa is upholstered over an engineered foam core. The foam is slotted over a plywood and steel bracket frame. Legs are available in steel with polyester powder coat or bright chrome finishes, or machined solid wood.

Notes

Nominal dimensions rounded to the nearest 1/2 inch.

Type	Width	Depth	Height	Seat Ht.
20	66 1/2	31 1/2	30	16
30	91 1/2	31 1/2	30	16

Customer's Own Material (COM) requires the following yardage:

Type	Total	Outer	Seat
20xx1	5 1/2	—	—
20xx2	—	4 1/4	2 1/4
30xx1	7	—	—
30xx2	—	5 1/4	3

Customer's Own Leather (COL) requires the following square feet:

Type	Total	Outer	Seat
20xx1	99	—	—
20xx2	—	76 1/2	40 1/2
30xx1	126	—	—
30xx2	—	94 1/2	54

Dimensions

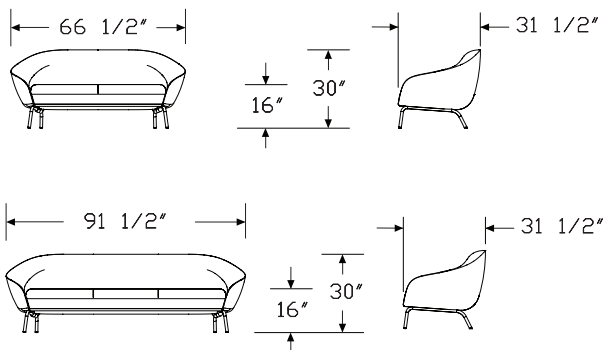

Specification Information

Step 1.

NOEVE

Step 2. Type

- 20** 2 seat sofa
- 30** 3 seat sofa

Step 3. Base Type

- ST** steel legs
- WD** wooden legs

Step 4. Upholstery

- 1** single fabric
- 2** multiple fabric

Prices for Steps 1-4.

		1	2
NOEVE	20 ST	\$5010	5010
	WD	\$5010	5010
	30 ST	\$6031	6031
	WD	\$6031	6031

Step 5. Base Finish

For 2 seat sofa (20) or 3 seat sofa (30) with steel legs (ST)

CHR	chrome <input type="checkbox"/>	+\$86
R00	black RAL 9005 <input type="checkbox"/>	+\$0
R02	stone grey RAL 7030 <input type="checkbox"/>	+\$140
R03	silver - RAL 9006 <input type="checkbox"/>	+\$140
R08	traffic orange RAL 2009 <input type="checkbox"/>	+\$140
R13	pastel blue RAL 5024 <input type="checkbox"/>	+\$140
R14	signal white RAL9003 <input type="checkbox"/>	+\$0
R23	black grey RAL 7021 <input type="checkbox"/>	+\$140
R24	leaf green RAL 6002 <input type="checkbox"/>	+\$140
R25	pale green RAL 6021 <input type="checkbox"/>	+\$140
R28	light pink RAL 3015 <input type="checkbox"/>	+\$140
R29	dark blue RAL 5001 <input type="checkbox"/>	+\$140
R30	oyster RAL 1013 <input type="checkbox"/>	+\$140
R26	RAL 3020 red <input type="checkbox"/>	+\$140
R38	broom yellow RAL 1032 <input type="checkbox"/>	+\$140
R39	moss green RAL 6005 <input type="checkbox"/>	+\$140
R40	steel blue RAL 5011 <input type="checkbox"/>	+\$140

For 2 seat sofa (20) or 3 seat sofa (30) with wooden legs (WD)

OAK	oak <input type="checkbox"/>	+\$945
WLN	walnut <input type="checkbox"/>	+\$1304

Step 6. Fabric

<i>For 2 seat sofa (20) with single fabric (1)</i>		
Price Category (NaughtOne) 0	A	+\$0
Price Category (naughtone) 0	A	+\$0
Price Category (NaughtOne) 1	A	+\$0
Price Category (naughtone) 1	A	+\$0
Price Category (NaughtOne) 2	A	+\$209
Price Category (naughtone) 2	A	+\$209
Price Category (NaughtOne) 3	A	+\$416
Price Category (naughtone) 3	A	+\$416
Price Category (NaughtOne) 4	A	+\$625
Price Category (naughtone) 4	A	+\$625
Price Category (NaughtOne) 5	A	+\$1038
Price Category (naughtone) 5	A	+\$1038
Price Category (NaughtOne) 6	A	+\$1454
Price Category (naughtone) 6	A	+\$1454
Price Category (NaughtOne) 7	A	+\$1870
Price Category (naughtone) 7	A	+\$1870
Price Category (NaughtOne) 9	A	+\$2702
Price Category (naughtone) 9	A	+\$2702

<i>For 3 seat sofa (30) with single fabric (1)</i>		
Price Category (NaughtOne) 0	A	+\$0
Price Category (naughtone) 0	A	+\$0
Price Category (NaughtOne) 1	A	+\$0
Price Category (naughtone) 1	A	+\$0
Price Category (NaughtOne) 2	A	+\$262
Price Category (naughtone) 2	A	+\$262
Price Category (NaughtOne) 3	A	+\$523
Price Category (naughtone) 3	A	+\$523
Price Category (NaughtOne) 4	A	+\$783
Price Category (naughtone) 4	A	+\$783
Price Category (NaughtOne) 5	A	+\$1306
Price Category (naughtone) 5	A	+\$1306
Price Category (NaughtOne) 6	A	+\$1827
Price Category (naughtone) 6	A	+\$1827
Price Category (NaughtOne) 7	A	+\$2348
Price Category (naughtone) 7	A	+\$2348
Price Category (NaughtOne) 9	A	+\$3390
Price Category (naughtone) 9	A	+\$3390

Step 7. Outer Fabric

<i>For 2 seat sofa (20) with multiple fabric (2)</i>		
Price Category (NaughtOne) 0	A	+\$0
Price Category (naughtone) 0	A	+\$0
Price Category (NaughtOne) 1	A	+\$0
Price Category (naughtone) 1	A	+\$0
Price Category (NaughtOne) 2	A	+\$0
Price Category (naughtone) 2	A	+\$0
Price Category (NaughtOne) 3	A	+\$0
Price Category (naughtone) 3	A	+\$0
Price Category (NaughtOne) 4	A	+\$0
Price Category (naughtone) 4	A	+\$0
Price Category (NaughtOne) 5	A	+\$0
Price Category (naughtone) 5	A	+\$0
Price Category (NaughtOne) 6	A	+\$0
Price Category (naughtone) 6	A	+\$0
Price Category (NaughtOne) 7	A	+\$0
Price Category (naughtone) 7	A	+\$0
Price Category (NaughtOne) 9	A	+\$0
Price Category (naughtone) 9	A	+\$0

<i>For 3 seat sofa (30) with multiple fabric (2)</i>		
Price Category (NaughtOne) 0	A	+\$0
Price Category (naughtone) 0	A	+\$0
Price Category (NaughtOne) 1	A	+\$0
Price Category (naughtone) 1	A	+\$0
Price Category (NaughtOne) 2	A	+\$0
Price Category (naughtone) 2	A	+\$0
Price Category (NaughtOne) 3	A	+\$0
Price Category (naughtone) 3	A	+\$0
Price Category (NaughtOne) 4	A	+\$0
Price Category (naughtone) 4	A	+\$0
Price Category (NaughtOne) 5	A	+\$0
Price Category (naughtone) 5	A	+\$0
Price Category (NaughtOne) 6	A	+\$0
Price Category (naughtone) 6	A	+\$0
Price Category (NaughtOne) 7	A	+\$0
Price Category (naughtone) 7	A	+\$0
Price Category (NaughtOne) 9	A	+\$0
Price Category (naughtone) 9	A	+\$0

Step 8. Seat Fabric

For 2 seat sofa (20) with multiple fabric (2)

Price Category (NaughtOne) 0	<input type="checkbox"/>	+\$49
Price Category (naughtone) 0	<input type="checkbox"/>	+\$49
Price Category (NaughtOne) 1	<input type="checkbox"/>	+\$49
Price Category (naughtone) 1	<input type="checkbox"/>	+\$49
Price Category (NaughtOne) 2	<input type="checkbox"/>	+\$190
Price Category (naughtone) 2	<input type="checkbox"/>	+\$190
Price Category (NaughtOne) 3	<input type="checkbox"/>	+\$284
Price Category (naughtone) 3	<input type="checkbox"/>	+\$284
Price Category (NaughtOne) 4	<input type="checkbox"/>	+\$378
Price Category (naughtone) 4	<input type="checkbox"/>	+\$378
Price Category (NaughtOne) 5	<input type="checkbox"/>	+\$562
Price Category (naughtone) 5	<input type="checkbox"/>	+\$562
Price Category (NaughtOne) 6	<input type="checkbox"/>	+\$746
Price Category (naughtone) 6	<input type="checkbox"/>	+\$746
Price Category (NaughtOne) 7	<input type="checkbox"/>	+\$930
Price Category (naughtone) 7	<input type="checkbox"/>	+\$930
Price Category (NaughtOne) 9	<input type="checkbox"/>	+\$1297
Price Category (naughtone) 9	<input type="checkbox"/>	+\$1297

For 3 seat sofa (30) with multiple fabric (2)

Price Category (NaughtOne) 0	<input type="checkbox"/>	+\$89
Price Category (naughtone) 0	<input type="checkbox"/>	+\$89
Price Category (NaughtOne) 1	<input type="checkbox"/>	+\$89
Price Category (naughtone) 1	<input type="checkbox"/>	+\$89
Price Category (NaughtOne) 2	<input type="checkbox"/>	+\$310
Price Category (naughtone) 2	<input type="checkbox"/>	+\$310
Price Category (NaughtOne) 3	<input type="checkbox"/>	+\$443
Price Category (naughtone) 3	<input type="checkbox"/>	+\$443
Price Category (NaughtOne) 4	<input type="checkbox"/>	+\$575
Price Category (naughtone) 4	<input type="checkbox"/>	+\$575
Price Category (NaughtOne) 5	<input type="checkbox"/>	+\$839
Price Category (naughtone) 5	<input type="checkbox"/>	+\$839
Price Category (NaughtOne) 6	<input type="checkbox"/>	+\$1104
Price Category (naughtone) 6	<input type="checkbox"/>	+\$1104
Price Category (NaughtOne) 7	<input type="checkbox"/>	+\$1370
Price Category (naughtone) 7	<input type="checkbox"/>	+\$1370
Price Category (NaughtOne) 9	<input type="checkbox"/>	+\$1899
Price Category (naughtone) 9	<input type="checkbox"/>	+\$1899

Hue 2 Seat Sofa

NOHES

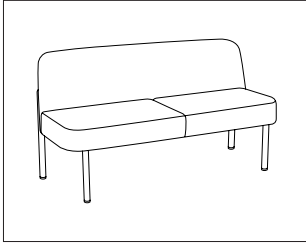

Product Information

Description

This sofa is upholstered over a machined plywood inner frame topped with high quality foams. It can be upholstered in a single fabric or multiple fabrics. The laser-cut, CNC-bent and welded steel frame is available in a choice of RAL colors.

Notes

Nominal dimensions rounded to the nearest 1/2 inch.

Type	Width	Depth	Height	Seat Ht.
20	55	25	29 1/2	17 1/2
25	55	25	41 1/2	29 1/2

Customer's Own Material (COM) requires the following yardage:

Type	Total	Back/Screen	Seat
20	5 1/4	3 1/4	2
25	5 1/4	3 1/4	2

Customer's Own Leather (COL) requires the following square feet:

Type	Total	Back/Screen	Seat
20	62	32	30
25	62	32	30

Specification Information

Step 1.

NOHES2

Step 2. Type

20 standard height no arms

25 bar height no arms

Step 3. Upholstery

1 single fabric

2 multiple fabric

Prices for Steps 1-3.

	1	2
NOHES2 20	\$5651	5651
25	\$5738	5738

Step 4. Base Finish

R00	RAL 9005 black <input type="checkbox"/>	+\$0
R02	RAL 7030 stone grey <input type="checkbox"/>	+\$280
R03	RAL 9006 silver <input type="checkbox"/>	+\$280
R08	RAL 2009 orange <input type="checkbox"/>	+\$280
R13	RAL 5024 pastel blue <input type="checkbox"/>	+\$280
R14	RAL 9003 white <input type="checkbox"/>	+\$0
R23	RAL 7021 black grey <input type="checkbox"/>	+\$280
R24	leaf green RAL 6002 <input type="checkbox"/>	+\$0
R25	RAL 6021 green <input type="checkbox"/>	+\$280
R26	RAL 3020 red <input type="checkbox"/>	+\$280
R28	RAL 3015 light pink <input type="checkbox"/>	+\$280
R29	RAL 5001 blue <input type="checkbox"/>	+\$280
R30	RAL 1013 oyster <input type="checkbox"/>	+\$280
R38	broom yellow RAL 1032 <input type="checkbox"/>	+\$280
R39	moss green RAL 6005 <input type="checkbox"/>	+\$280
R40	steel blue RAL 5011 <input type="checkbox"/>	+\$280

NaughtOne Sofa

Step 5. Fabric

For standard height no arms (20) with single fabric (1)

Price Category (NaughtOne) 0	A	+\$0
Price Category (naughtone) 0	A	+\$0
Price Category (NaughtOne) 1	A	+\$0
Price Category (naughtone) 1	A	+\$0
Price Category (NaughtOne) 2	A	+\$99
Price Category (naughtone) 2	A	+\$99
Price Category (NaughtOne) 3	A	+\$198
Price Category (naughtone) 3	A	+\$198
Price Category (NaughtOne) 4	A	+\$294
Price Category (naughtone) 4	A	+\$294
Price Category (NaughtOne) 5	A	+\$493
Price Category (naughtone) 5	A	+\$493
Price Category (NaughtOne) 6	A	+\$688
Price Category (naughtone) 6	A	+\$688
Price Category (NaughtOne) 7	A	+\$884
Price Category (naughtone) 7	A	+\$884
Price Category (NaughtOne) 9	A	+\$1275
Price Category (naughtone) 9	A	+\$1275

For bar height no arms (25) with single fabric (1)

Price Category (NaughtOne) 0	A	+\$0
Price Category (naughtone) 0	A	+\$0
Price Category (NaughtOne) 1	A	+\$0
Price Category (naughtone) 1	A	+\$0
Price Category (NaughtOne) 2	A	+\$99
Price Category (naughtone) 2	A	+\$99
Price Category (NaughtOne) 3	A	+\$196
Price Category (naughtone) 3	A	+\$196
Price Category (NaughtOne) 4	A	+\$294
Price Category (naughtone) 4	A	+\$294
Price Category (NaughtOne) 5	A	+\$491
Price Category (naughtone) 5	A	+\$491
Price Category (NaughtOne) 6	A	+\$686
Price Category (naughtone) 6	A	+\$686
Price Category (NaughtOne) 7	A	+\$882
Price Category (naughtone) 7	A	+\$882
Price Category (NaughtOne) 9	A	+\$1273
Price Category (naughtone) 9	A	+\$1273

Step 6. Back Fabric

For standard height no arms (20) with multiple fabric (2)

Price Category (NaughtOne) 0	A	+\$0
Price Category (naughtone) 0	A	+\$0
Price Category (NaughtOne) 1	A	+\$0
Price Category (naughtone) 1	A	+\$0
Price Category (NaughtOne) 2	A	+\$42
Price Category (naughtone) 2	A	+\$42
Price Category (NaughtOne) 3	A	+\$83
Price Category (naughtone) 3	A	+\$83
Price Category (NaughtOne) 4	A	+\$124
Price Category (naughtone) 4	A	+\$124
Price Category (NaughtOne) 5	A	+\$208
Price Category (naughtone) 5	A	+\$208
Price Category (NaughtOne) 6	A	+\$290
Price Category (naughtone) 6	A	+\$290
Price Category (NaughtOne) 7	A	+\$372
Price Category (naughtone) 7	A	+\$372
Price Category (NaughtOne) 9	A	+\$537
Price Category (naughtone) 9	A	+\$537

For bar height no arms (25) with multiple fabric (2)

Price Category (NaughtOne) 0	A	+\$0
Price Category (naughtone) 0	A	+\$0
Price Category (NaughtOne) 1	A	+\$0
Price Category (naughtone) 1	A	+\$0
Price Category (NaughtOne) 2	A	+\$42
Price Category (naughtone) 2	A	+\$42
Price Category (NaughtOne) 3	A	+\$82
Price Category (naughtone) 3	A	+\$82
Price Category (NaughtOne) 4	A	+\$124
Price Category (naughtone) 4	A	+\$124
Price Category (NaughtOne) 5	A	+\$207
Price Category (naughtone) 5	A	+\$207
Price Category (NaughtOne) 6	A	+\$289
Price Category (naughtone) 6	A	+\$289
Price Category (NaughtOne) 7	A	+\$371
Price Category (naughtone) 7	A	+\$371
Price Category (NaughtOne) 9	A	+\$536
Price Category (naughtone) 9	A	+\$536

Hue 2 Seat Sofa *continued*

Step 7. Seat Fabric

For standard height no arms (20) with multiple fabric (2)

Price Category (NaughtOne) 0	<input type="checkbox"/>	+\$0
Price Category (naughtone) 0	<input type="checkbox"/>	+\$0
Price Category (NaughtOne) 1	<input type="checkbox"/>	+\$88
Price Category (naughtone) 1	<input type="checkbox"/>	+\$88
Price Category (NaughtOne) 2	<input type="checkbox"/>	+\$176
Price Category (naughtone) 2	<input type="checkbox"/>	+\$176
Price Category (NaughtOne) 3	<input type="checkbox"/>	+\$260
Price Category (naughtone) 3	<input type="checkbox"/>	+\$260
Price Category (NaughtOne) 4	<input type="checkbox"/>	+\$344
Price Category (naughtone) 4	<input type="checkbox"/>	+\$344
Price Category (NaughtOne) 5	<input type="checkbox"/>	+\$518
Price Category (naughtone) 5	<input type="checkbox"/>	+\$518
Price Category (NaughtOne) 6	<input type="checkbox"/>	+\$688
Price Category (naughtone) 6	<input type="checkbox"/>	+\$688
Price Category (NaughtOne) 7	<input type="checkbox"/>	+\$862
Price Category (naughtone) 7	<input type="checkbox"/>	+\$862

For bar height no arms (25) with multiple fabric (2)

Price Category (NaughtOne) 0	<input type="checkbox"/>	+\$0
Price Category (naughtone) 0	<input type="checkbox"/>	+\$0
Price Category (NaughtOne) 1	<input type="checkbox"/>	+\$88
Price Category (naughtone) 1	<input type="checkbox"/>	+\$88
Price Category (NaughtOne) 2	<input type="checkbox"/>	+\$176
Price Category (naughtone) 2	<input type="checkbox"/>	+\$176
Price Category (NaughtOne) 3	<input type="checkbox"/>	+\$259
Price Category (naughtone) 3	<input type="checkbox"/>	+\$259
Price Category (NaughtOne) 4	<input type="checkbox"/>	+\$344
Price Category (naughtone) 4	<input type="checkbox"/>	+\$344
Price Category (NaughtOne) 5	<input type="checkbox"/>	+\$517
Price Category (naughtone) 5	<input type="checkbox"/>	+\$517
Price Category (NaughtOne) 6	<input type="checkbox"/>	+\$687
Price Category (naughtone) 6	<input type="checkbox"/>	+\$687
Price Category (NaughtOne) 7	<input type="checkbox"/>	+\$861
Price Category (naughtone) 7	<input type="checkbox"/>	+\$861

Pullman Sofa

NOPUL

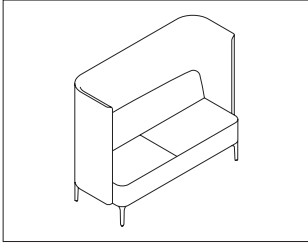

NaughtOne Sofa

Product Information

Description
 The Pullman sofa is upholstered over a plywood inner frame topped with high quality foams. Pullman can be upholstered in a single fabric or multiple fabrics. Legs are laser cut folded mild steel and solid wood.

Notes

Customer's Own Material (COM) requires the following yardage:

Type	Total	Inner & Seat	Outer
7	11	4	7
8	14	5	9

Customer's Own Leather (COL) requires the following square feet:

Type	Total	Inner & Seat	Outer
7	176	64	112
8	224	80	144

Dimensions

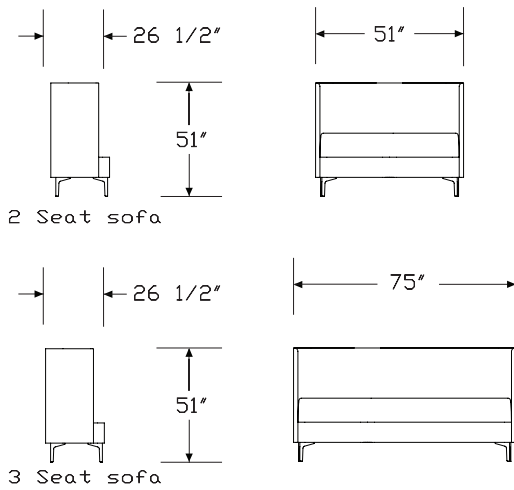

Specification Information

Step 1.

NOPUL A

Step 2. Type

- 7** 2 seat sofa A
- 8** 3 seat sofa A

Step 3. Upholstery

- 1** single fabric A
- 2** multiple fabric A

Step 4. Power Access Cut-out

For 2 seat sofa (7) or 3 seat sofa (8)

- OCS** no cut-out system A
- WNDB** with node cut-out system (both sides) A
- WNDL** with node cut-out system (left hand side) A
- WNRD** with node cut-out system (right hand side) A

Step 5. Tablet Arm Option

For 2 seat sofa (7) or 3 seat sofa (8)

- 00** no tablet arm A

Prices for Steps 1-5.

		OCS00	WNDB00	WNDL00	WNR00
NOPUL 7	1	\$8397	8859	8859	8859
	2	\$8397	8859	8859	8859
8	1	\$9585	10048	10048	10048
	2	\$9585	10048	10048	10048

Pullman Sofa *continued*

Step 6. Base Finish

R00	RAL 9005 black <input type="checkbox"/>	+\$0
R02	RAL 7030 stone grey <input type="checkbox"/>	+\$177
R03	RAL 9006 silver <input type="checkbox"/>	+\$177
R08	RAL 2009 orange <input type="checkbox"/>	+\$177
R13	RAL 5024 pastel blue <input type="checkbox"/>	+\$177
R14	RAL 9003 white <input type="checkbox"/>	+\$0
R23	RAL 7021 black grey <input type="checkbox"/>	+\$177
R24	leaf green RAL 6002 <input type="checkbox"/>	+\$177
R25	RAL 6021 green <input type="checkbox"/>	+\$177
R26	RAL 3020 red <input type="checkbox"/>	+\$177
R28	RAL 3015 light pink <input type="checkbox"/>	+\$177
R29	RAL 5001 blue <input type="checkbox"/>	+\$177
R30	RAL 1013 oyster <input type="checkbox"/>	+\$177
R38	broom yellow RAL 1032 <input type="checkbox"/>	+\$177
R39	moss green RAL 6005 <input type="checkbox"/>	+\$177
R40	steel blue RAL 5011 <input type="checkbox"/>	+\$177
OAK	oak <input type="checkbox"/>	+\$714
WLN	walnut <input type="checkbox"/>	+\$1243

Step 7. Fabric

For 2 seat sofa (7) with single fabric (1)

Price Category (NaughtOne) 0 <input type="checkbox"/>	+\$0
Price Category (naughtone) 0 <input type="checkbox"/>	+\$0
Price Category (NaughtOne) 1 <input type="checkbox"/>	+\$0
Price Category (naughtone) 1 <input type="checkbox"/>	+\$0
Price Category (NaughtOne) 2 <input type="checkbox"/>	+\$275
Price Category (naughtone) 2 <input type="checkbox"/>	+\$275
Price Category (NaughtOne) 3 <input type="checkbox"/>	+\$551
Price Category (naughtone) 3 <input type="checkbox"/>	+\$551
Price Category (NaughtOne) 4 <input type="checkbox"/>	+\$826
Price Category (naughtone) 4 <input type="checkbox"/>	+\$826
Price Category (NaughtOne) 5 <input type="checkbox"/>	+\$1374
Price Category (naughtone) 5 <input type="checkbox"/>	+\$1374
Price Category (NaughtOne) 6 <input type="checkbox"/>	+\$1925
Price Category (naughtone) 6 <input type="checkbox"/>	+\$1925
Price Category (NaughtOne) 7 <input type="checkbox"/>	+\$2476
Price Category (naughtone) 7 <input type="checkbox"/>	+\$2476

For 3 seat sofa (8) with single fabric (1)

Price Category (NaughtOne) 0 <input type="checkbox"/>	+\$0
Price Category (naughtone) 0 <input type="checkbox"/>	+\$0
Price Category (NaughtOne) 1 <input type="checkbox"/>	+\$0
Price Category (naughtone) 1 <input type="checkbox"/>	+\$0
Price Category (NaughtOne) 2 <input type="checkbox"/>	+\$356
Price Category (naughtone) 2 <input type="checkbox"/>	+\$356
Price Category (NaughtOne) 3 <input type="checkbox"/>	+\$712
Price Category (naughtone) 3 <input type="checkbox"/>	+\$712
Price Category (NaughtOne) 4 <input type="checkbox"/>	+\$1070
Price Category (naughtone) 4 <input type="checkbox"/>	+\$1070
Price Category (NaughtOne) 5 <input type="checkbox"/>	+\$1782
Price Category (naughtone) 5 <input type="checkbox"/>	+\$1782
Price Category (NaughtOne) 6 <input type="checkbox"/>	+\$2494
Price Category (naughtone) 6 <input type="checkbox"/>	+\$2494
Price Category (NaughtOne) 7 <input type="checkbox"/>	+\$3208
Price Category (naughtone) 7 <input type="checkbox"/>	+\$3208

Step 8. Seat and Backrest Fabric

For 2 seat sofa (7) with multiple fabric (2)

Price Category (NaughtOne) 0 <input type="checkbox"/>	+\$0
Price Category (naughtone) 0 <input type="checkbox"/>	+\$0
Price Category (NaughtOne) 1 <input type="checkbox"/>	+\$0
Price Category (naughtone) 1 <input type="checkbox"/>	+\$0
Price Category (NaughtOne) 2 <input type="checkbox"/>	+\$75
Price Category (naughtone) 2 <input type="checkbox"/>	+\$75
Price Category (NaughtOne) 3 <input type="checkbox"/>	+\$152
Price Category (naughtone) 3 <input type="checkbox"/>	+\$152
Price Category (NaughtOne) 4 <input type="checkbox"/>	+\$227
Price Category (naughtone) 4 <input type="checkbox"/>	+\$227
Price Category (NaughtOne) 5 <input type="checkbox"/>	+\$379
Price Category (naughtone) 5 <input type="checkbox"/>	+\$379
Price Category (NaughtOne) 6 <input type="checkbox"/>	+\$530
Price Category (naughtone) 6 <input type="checkbox"/>	+\$530
Price Category (NaughtOne) 7 <input type="checkbox"/>	+\$682
Price Category (naughtone) 7 <input type="checkbox"/>	+\$682
Price Category (NaughtOne) 9 <input type="checkbox"/>	+\$984
Price Category (naughtone) 9 <input type="checkbox"/>	+\$984

For 3 seat sofa (8) with multiple fabric (2)

Price Category (NaughtOne) 0 <input type="checkbox"/>	+\$0
Price Category (naughtone) 0 <input type="checkbox"/>	+\$0
Price Category (NaughtOne) 1 <input type="checkbox"/>	+\$0
Price Category (naughtone) 1 <input type="checkbox"/>	+\$0
Price Category (NaughtOne) 2 <input type="checkbox"/>	+\$98
Price Category (naughtone) 2 <input type="checkbox"/>	+\$98
Price Category (NaughtOne) 3 <input type="checkbox"/>	+\$194
Price Category (naughtone) 3 <input type="checkbox"/>	+\$194
Price Category (NaughtOne) 4 <input type="checkbox"/>	+\$294
Price Category (naughtone) 4 <input type="checkbox"/>	+\$294
Price Category (NaughtOne) 5 <input type="checkbox"/>	+\$490
Price Category (naughtone) 5 <input type="checkbox"/>	+\$490
Price Category (NaughtOne) 6 <input type="checkbox"/>	+\$687
Price Category (naughtone) 6 <input type="checkbox"/>	+\$687
Price Category (NaughtOne) 7 <input type="checkbox"/>	+\$882
Price Category (naughtone) 7 <input type="checkbox"/>	+\$882
Price Category (NaughtOne) 9 <input type="checkbox"/>	+\$1274
Price Category (naughtone) 9 <input type="checkbox"/>	+\$1274

Step 9. Outer Fabric

For 2 seat sofa (7) with multiple fabric (2)

Price Category (NaughtOne) 0 <input type="checkbox"/>	+\$0
Price Category (naughtone) 0 <input type="checkbox"/>	+\$0
Price Category (NaughtOne) 1 <input type="checkbox"/>	+\$0
Price Category (naughtone) 1 <input type="checkbox"/>	+\$0
Price Category (NaughtOne) 2 <input type="checkbox"/>	+\$200
Price Category (naughtone) 2 <input type="checkbox"/>	+\$200
Price Category (NaughtOne) 3 <input type="checkbox"/>	+\$399
Price Category (naughtone) 3 <input type="checkbox"/>	+\$399
Price Category (NaughtOne) 4 <input type="checkbox"/>	+\$599
Price Category (naughtone) 4 <input type="checkbox"/>	+\$599
Price Category (NaughtOne) 5 <input type="checkbox"/>	+\$995
Price Category (naughtone) 5 <input type="checkbox"/>	+\$995
Price Category (NaughtOne) 6 <input type="checkbox"/>	+\$1395
Price Category (naughtone) 6 <input type="checkbox"/>	+\$1395
Price Category (NaughtOne) 7 <input type="checkbox"/>	+\$1793
Price Category (naughtone) 7 <input type="checkbox"/>	+\$1793
Price Category (NaughtOne) 9 <input type="checkbox"/>	+\$2592
Price Category (naughtone) 9 <input type="checkbox"/>	+\$2592

For 3 seat sofa (8) with multiple fabric (2)

Price Category (NaughtOne) 0 <input type="checkbox"/>	+\$0
Price Category (naughtone) 0 <input type="checkbox"/>	+\$0
Price Category (NaughtOne) 1 <input type="checkbox"/>	+\$0
Price Category (naughtone) 1 <input type="checkbox"/>	+\$0
Price Category (NaughtOne) 2 <input type="checkbox"/>	+\$259
Price Category (naughtone) 2 <input type="checkbox"/>	+\$259
Price Category (NaughtOne) 3 <input type="checkbox"/>	+\$517
Price Category (naughtone) 3 <input type="checkbox"/>	+\$517
Price Category (NaughtOne) 4 <input type="checkbox"/>	+\$776
Price Category (naughtone) 4 <input type="checkbox"/>	+\$776
Price Category (NaughtOne) 5 <input type="checkbox"/>	+\$1293
Price Category (naughtone) 5 <input type="checkbox"/>	+\$1293
Price Category (NaughtOne) 6 <input type="checkbox"/>	+\$1806
Price Category (naughtone) 6 <input type="checkbox"/>	+\$1806
Price Category (NaughtOne) 7 <input type="checkbox"/>	+\$2326
Price Category (naughtone) 7 <input type="checkbox"/>	+\$2326
Price Category (NaughtOne) 9 <input type="checkbox"/>	+\$3358
Price Category (naughtone) 9 <input type="checkbox"/>	+\$3358

Step 10. Power Option

For 2 seat sofa (7) or 3 seat sofa (8) with with node cut-out system (left hand side) (WNDL), or with node cut-out system (right hand side) (WNR)

ND1W node power unit with 1x power and 2x USB in white <input type="checkbox"/>	+\$365
ND1B node power unit with 1x power and 2x USB in black <input type="checkbox"/>	+\$365
ND2W node power unit with 2x power in white <input type="checkbox"/>	+\$298
ND2B node power unit with 2x power in black <input type="checkbox"/>	+\$298

For 2 seat sofa (7) or 3 seat sofa (8) with with node cut-out system (both sides) (WNRB)

ND1W node power unit with 1x power and 2x USB in white <input type="checkbox"/>	+\$730
ND1B node power unit with 1x power and 2x USB in black <input type="checkbox"/>	+\$730
ND2W node power unit with 2x power in white <input type="checkbox"/>	+\$597
ND2B node power unit with 2x power in black <input type="checkbox"/>	+\$597



Product Information

Description

This stool has a base of laser cut, bent and welded steel tube, finished with polyester powder coat. Seat top is solid hardwood finished with a clear lacquer.

Notes

Nominal dimensions rounded to the nearest 1/2 inch.

Type	Width	Depth	Height
LO	14	14	17½
CH	17	17	25½
BS	17	17	29½

Specification Information

Step 1.

NOPEN

Step 2. Type

LO low stool

CH counter height stool

BS barstool

Prices for Steps 1-2.

NOPEN LO	\$700
CH	\$870
BS	\$870

Step 3. Leg Finish

R00 black RAL 9005 <input type="checkbox"/>	+\$0
R02 stone grey RAL 7030 <input type="checkbox"/>	+\$141
R03 silver - RAL 9006 <input type="checkbox"/>	+\$141
R08 traffic orange RAL 2009 <input type="checkbox"/>	+\$141
R13 pastel blue RAL 5024 <input type="checkbox"/>	+\$141
R14 signal white RAL9003 <input type="checkbox"/>	+\$0
R23 black grey RAL 7021 <input type="checkbox"/>	+\$141
R24 leaf green RAL 6002 <input type="checkbox"/>	+\$141
R25 pale green RAL 6021 <input type="checkbox"/>	+\$141
R26 RAL 3020 red <input type="checkbox"/>	+\$141
R28 light pink RAL 3015 <input type="checkbox"/>	+\$141
R29 dark blue RAL 5001 <input type="checkbox"/>	+\$141
R30 oyster RAL 1013 <input type="checkbox"/>	+\$141
R38 broom yellow RAL 1032 <input type="checkbox"/>	+\$141
R39 moss green RAL 6005 <input type="checkbox"/>	+\$141
R40 steel blue RAL 5011 <input type="checkbox"/>	+\$141

Step 4. Seat Finish

OAK oak <input type="checkbox"/>	+\$0
WLN walnut <input type="checkbox"/>	+\$125

Pullman Booth

NOPUL

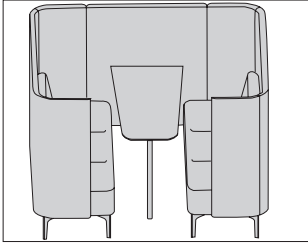

Product Information

Description
 The Pullman booth is available in two-tone fabric. Inner fabric covers the seat and back on the inside of the booth and outer fabric covers the inner and outer walls of the booth.

Notes

- Order accessory products separately:
- White board (NOPULAWB)
 - TV bracket (NOPULATVB)

Customer's Own Material (COM) requires the following yardage:

Type	Total	Inner & Seat	Outer
2	23	8	15
3	28	10	18
2W	25	8	17
3W	30	10	20

Customer's Own Leather (COL) requires the following square feet:

Type	Total	Inner & Seat	Outer
2	368	128	240
3	448	160	288
2W	400	128	272
3W	480	160	320

Specification Information

Step 1.

NOPUL

Step 2. Type

- 2** 2-seat booth
- 2W** 2-seat booth wide
- 3** 3-seat booth
- 3W** 3-seat booth wide

Prices for Steps 1-2.

NOPUL 2	\$20418
2W	\$21264
3	\$23589
3W	\$24435

Step 3. Base Finish

- R00** black RAL 9005 +\$0
- R02** stone grey RAL 7030 +\$370
- R03** silver - RAL 9006 +\$370
- R08** traffic orange RAL 2009 +\$370
- R13** pastel blue RAL 5024 +\$370
- R14** white RAL 9003 +\$0
- R23** black grey RAL 7021 +\$370
- R24** leaf green RAL 6002 +\$370
- R25** pale green RAL 6021 +\$370
- R26** RAL 3020 red +\$370
- R28** light pink RAL 3015 +\$370
- R29** dark blue RAL 5001 +\$370
- R30** oyster RAL 1013 +\$370
- OAK** oak +\$1263
- WLN** walnut +\$2150
- R38** broom yellow RAL 1032 +\$370
- R39** moss green RAL 6005 +\$370
- R40** steel blue RAL 5011 +\$370

NaughtOne Booths

Pullman Booth *continued*

Step 4. Surface Finish

For 2-seat booth (2) or 2-seat booth wide (2W)

BRC	black MFMDf top with reverse chamfer edge <input type="checkbox"/>	+\$0
BSE	black MFMDf top with edge band <input type="checkbox"/>	+\$0
WRC	white MFMDf top with reverse chamfer edge <input type="checkbox"/>	+\$0
WSE	white MFMDf top with edge band <input type="checkbox"/>	+\$0
OAK	oak veneer top with reverse chamfer edge <input type="checkbox"/>	+\$120
WLN	walnut veneer top with reverse chamfer edge <input type="checkbox"/>	+\$120
Q23	4123 nero forbo lino top with reverse chamfer edge <input type="checkbox"/>	+\$358
Q32	4132 ash forbo lino top with reverse chamfer edge <input type="checkbox"/>	+\$358
Q55	4155 pewter forbo lino top with reverse chamfer edge <input type="checkbox"/>	+\$358
Q66	4166 charcoal forbo lino top with reverse chamfer edge <input type="checkbox"/>	+\$358
Q72	4172 mauve forbo lino top with reverse chamfer edge <input type="checkbox"/>	+\$358
Q75	4175 pebble forbo lino top with reverse chamfer edge <input type="checkbox"/>	+\$358
Q76	4176 mushroom forbo lino top with reverse chamfer edge <input type="checkbox"/>	+\$358
Q79	4179 smokey blue forbo lino top with reverse chamfer edge <input type="checkbox"/>	+\$358

For 3-seat booth (3) or 3-seat booth wide (3W)

BRC	black MFMDf top with reverse chamfer edge <input type="checkbox"/>	+\$0
BSE	black MFMDf top with edge band <input type="checkbox"/>	+\$0
WRC	white MFMDf top with reverse chamfer edge <input type="checkbox"/>	+\$0
WSE	white MFMDf top with edge band <input type="checkbox"/>	+\$0
OAK	oak veneer top with reverse chamfer edge <input type="checkbox"/>	+\$135
WLN	walnut veneer top with reverse chamfer edge <input type="checkbox"/>	+\$135
Q23	4123 nero forbo lino top with reverse chamfer edge <input type="checkbox"/>	+\$348
Q32	4132 ash forbo lino top with reverse chamfer edge <input type="checkbox"/>	+\$348
Q55	4155 pewter forbo lino top with reverse chamfer edge <input type="checkbox"/>	+\$348
Q66	4166 charcoal forbo lino top with reverse chamfer edge <input type="checkbox"/>	+\$348
Q72	4172 mauve forbo lino top with reverse chamfer edge <input type="checkbox"/>	+\$348
Q75	4175 pebble forbo lino top with reverse chamfer edge <input type="checkbox"/>	+\$348
Q76	4176 mushroom forbo lino top with reverse chamfer edge <input type="checkbox"/>	+\$348
Q79	4179 smokey blue forbo lino top with reverse chamfer edge <input type="checkbox"/>	+\$348

Step 5. Inner Fabric (Seat and Midback)

For 2-seat booth (2)

Price Category (NaughtOne) 0 <input type="checkbox"/>	+\$0
Price Category (naughtone) 0 <input type="checkbox"/>	+\$0
Price Category (NaughtOne) 1 <input type="checkbox"/>	+\$0
Price Category (naughtone) 1 <input type="checkbox"/>	+\$0
Price Category (NaughtOne) 2 <input type="checkbox"/>	+\$285
Price Category (naughtone) 2 <input type="checkbox"/>	+\$285
Price Category (NaughtOne) 3 <input type="checkbox"/>	+\$570
Price Category (naughtone) 3 <input type="checkbox"/>	+\$570
Price Category (NaughtOne) 4 <input type="checkbox"/>	+\$856
Price Category (naughtone) 4 <input type="checkbox"/>	+\$856
Price Category (NaughtOne) 5 <input type="checkbox"/>	+\$1426
Price Category (naughtone) 5 <input type="checkbox"/>	+\$1426
Price Category (NaughtOne) 6 <input type="checkbox"/>	+\$1996
Price Category (naughtone) 6 <input type="checkbox"/>	+\$1996
Price Category (NaughtOne) 7 <input type="checkbox"/>	+\$2567
Price Category (naughtone) 7 <input type="checkbox"/>	+\$2567
Price Category (NaughtOne) 9 <input type="checkbox"/>	+\$3707
Price Category (naughtone) 9 <input type="checkbox"/>	+\$3707

For 2-seat booth wide (2W)

Price Category (NaughtOne) 0 <input type="checkbox"/>	+\$0
Price Category (naughtone) 0 <input type="checkbox"/>	+\$0
Price Category (NaughtOne) 1 <input type="checkbox"/>	+\$0
Price Category (naughtone) 1 <input type="checkbox"/>	+\$0
Price Category (NaughtOne) 2 <input type="checkbox"/>	+\$301
Price Category (naughtone) 2 <input type="checkbox"/>	+\$301
Price Category (NaughtOne) 3 <input type="checkbox"/>	+\$602
Price Category (naughtone) 3 <input type="checkbox"/>	+\$602
Price Category (NaughtOne) 4 <input type="checkbox"/>	+\$903
Price Category (naughtone) 4 <input type="checkbox"/>	+\$903
Price Category (NaughtOne) 5 <input type="checkbox"/>	+\$1505
Price Category (naughtone) 5 <input type="checkbox"/>	+\$1505
Price Category (NaughtOne) 6 <input type="checkbox"/>	+\$2107
Price Category (naughtone) 6 <input type="checkbox"/>	+\$2107
Price Category (NaughtOne) 7 <input type="checkbox"/>	+\$2709
Price Category (naughtone) 7 <input type="checkbox"/>	+\$2709
Price Category (NaughtOne) 9 <input type="checkbox"/>	+\$3914
Price Category (naughtone) 9 <input type="checkbox"/>	+\$3914

For 3-seat booth (3)

Price Category (NaughtOne) 0 <input type="checkbox"/>	+\$0
Price Category (naughtone) 0 <input type="checkbox"/>	+\$0
Price Category (NaughtOne) 1 <input type="checkbox"/>	+\$0
Price Category (naughtone) 1 <input type="checkbox"/>	+\$0
Price Category (NaughtOne) 2 <input type="checkbox"/>	+\$349
Price Category (naughtone) 2 <input type="checkbox"/>	+\$349
Price Category (NaughtOne) 3 <input type="checkbox"/>	+\$699
Price Category (naughtone) 3 <input type="checkbox"/>	+\$699
Price Category (NaughtOne) 4 <input type="checkbox"/>	+\$1048
Price Category (naughtone) 4 <input type="checkbox"/>	+\$1048
Price Category (NaughtOne) 5 <input type="checkbox"/>	+\$1747
Price Category (naughtone) 5 <input type="checkbox"/>	+\$1747
Price Category (NaughtOne) 6 <input type="checkbox"/>	+\$2447
Price Category (naughtone) 6 <input type="checkbox"/>	+\$2447
Price Category (NaughtOne) 7 <input type="checkbox"/>	+\$3146
Price Category (naughtone) 7 <input type="checkbox"/>	+\$3146
Price Category (NaughtOne) 9 <input type="checkbox"/>	+\$4544
Price Category (naughtone) 9 <input type="checkbox"/>	+\$4544

For 3-seat booth wide (3W)

Price Category (NaughtOne) 0 <input type="checkbox"/>	+\$0
Price Category (naughtone) 0 <input type="checkbox"/>	+\$0
Price Category (NaughtOne) 1 <input type="checkbox"/>	+\$0
Price Category (naughtone) 1 <input type="checkbox"/>	+\$0
Price Category (NaughtOne) 2 <input type="checkbox"/>	+\$365
Price Category (naughtone) 2 <input type="checkbox"/>	+\$365
Price Category (NaughtOne) 3 <input type="checkbox"/>	+\$731
Price Category (naughtone) 3 <input type="checkbox"/>	+\$731
Price Category (NaughtOne) 4 <input type="checkbox"/>	+\$1096
Price Category (naughtone) 4 <input type="checkbox"/>	+\$1096
Price Category (NaughtOne) 5 <input type="checkbox"/>	+\$1827
Price Category (naughtone) 5 <input type="checkbox"/>	+\$1827
Price Category (NaughtOne) 6 <input type="checkbox"/>	+\$2558
Price Category (naughtone) 6 <input type="checkbox"/>	+\$2558
Price Category (NaughtOne) 7 <input type="checkbox"/>	+\$3165
Price Category (naughtone) 7 <input type="checkbox"/>	+\$3165
Price Category (NaughtOne) 9 <input type="checkbox"/>	+\$4377
Price Category (naughtone) 9 <input type="checkbox"/>	+\$4377

Step 6. Outer Fabric

For 2-seat booth (2)

Price Category (NaughtOne) 0 <input type="checkbox"/>	+\$0
Price Category (naughtone) 0 <input type="checkbox"/>	+\$0
Price Category (NaughtOne) 1 <input type="checkbox"/>	+\$0
Price Category (naughtone) 1 <input type="checkbox"/>	+\$0
Price Category (NaughtOne) 2 <input type="checkbox"/>	+\$504
Price Category (naughtone) 2 <input type="checkbox"/>	+\$504
Price Category (NaughtOne) 3 <input type="checkbox"/>	+\$1009
Price Category (naughtone) 3 <input type="checkbox"/>	+\$1009
Price Category (NaughtOne) 4 <input type="checkbox"/>	+\$1513
Price Category (naughtone) 4 <input type="checkbox"/>	+\$1513
Price Category (NaughtOne) 5 <input type="checkbox"/>	+\$2523
Price Category (naughtone) 5 <input type="checkbox"/>	+\$2523
Price Category (NaughtOne) 6 <input type="checkbox"/>	+\$3532
Price Category (naughtone) 6 <input type="checkbox"/>	+\$3532
Price Category (NaughtOne) 7 <input type="checkbox"/>	+\$4540
Price Category (naughtone) 7 <input type="checkbox"/>	+\$4540
Price Category (NaughtOne) 9 <input type="checkbox"/>	+\$6558
Price Category (naughtone) 9 <input type="checkbox"/>	+\$6558

For 2-seat booth wide (2W)

Price Category (NaughtOne) 0 <input type="checkbox"/>	+\$0
Price Category (naughtone) 0 <input type="checkbox"/>	+\$0
Price Category (NaughtOne) 1 <input type="checkbox"/>	+\$0
Price Category (naughtone) 1 <input type="checkbox"/>	+\$0
Price Category (NaughtOne) 2 <input type="checkbox"/>	+\$531
Price Category (naughtone) 2 <input type="checkbox"/>	+\$531
Price Category (NaughtOne) 3 <input type="checkbox"/>	+\$1065
Price Category (naughtone) 3 <input type="checkbox"/>	+\$1065
Price Category (NaughtOne) 4 <input type="checkbox"/>	+\$1597
Price Category (naughtone) 4 <input type="checkbox"/>	+\$1597
Price Category (NaughtOne) 5 <input type="checkbox"/>	+\$2663
Price Category (naughtone) 5 <input type="checkbox"/>	+\$2663
Price Category (NaughtOne) 6 <input type="checkbox"/>	+\$3728
Price Category (naughtone) 6 <input type="checkbox"/>	+\$3728
Price Category (NaughtOne) 7 <input type="checkbox"/>	+\$4793
Price Category (naughtone) 7 <input type="checkbox"/>	+\$4793
Price Category (NaughtOne) 9 <input type="checkbox"/>	+\$6923
Price Category (naughtone) 9 <input type="checkbox"/>	+\$6923

Pullman Booth *continued*

For 3-seat booth (3)

Price Category (NaughtOne) 0	A	+\$0
Price Category (naughtone) 0	A	+\$0
Price Category (NaughtOne) 1	A	+\$0
Price Category (naughtone) 1	A	+\$0
Price Category (NaughtOne) 2	A	+\$612
Price Category (naughtone) 2	A	+\$612
Price Category (NaughtOne) 3	A	+\$1223
Price Category (naughtone) 3	A	+\$1223
Price Category (NaughtOne) 4	A	+\$1835
Price Category (naughtone) 4	A	+\$1835
Price Category (NaughtOne) 5	A	+\$3059
Price Category (naughtone) 5	A	+\$3059
Price Category (NaughtOne) 6	A	+\$4282
Price Category (naughtone) 6	A	+\$4282
Price Category (NaughtOne) 7	A	+\$5505
Price Category (naughtone) 7	A	+\$5505
Price Category (NaughtOne) 9	A	+\$7953
Price Category (naughtone) 9	A	+\$7953

For 3-seat booth wide (3W)

Price Category (NaughtOne) 0	A	+\$0
Price Category (naughtone) 0	A	+\$0
Price Category (NaughtOne) 1	A	+\$0
Price Category (naughtone) 1	A	+\$0
Price Category (NaughtOne) 2	A	+\$639
Price Category (naughtone) 2	A	+\$639
Price Category (NaughtOne) 3	A	+\$1279
Price Category (naughtone) 3	A	+\$1279
Price Category (NaughtOne) 4	A	+\$1918
Price Category (naughtone) 4	A	+\$1918
Price Category (NaughtOne) 5	A	+\$3198
Price Category (naughtone) 5	A	+\$3198
Price Category (NaughtOne) 6	A	+\$4478
Price Category (naughtone) 6	A	+\$4478
Price Category (NaughtOne) 7	A	+\$5539
Price Category (naughtone) 7	A	+\$5539
Price Category (NaughtOne) 9	A	+\$7661
Price Category (naughtone) 9	A	+\$7661

Coffee Tables

Meeting Tables

Desks



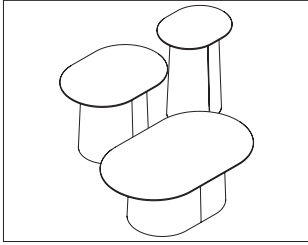

Product Information

Description

These coffee and side tables have a steel or upholstered base. The steel base is laser cut, machine bent and powdercoated. The upholstered base is foam over a CNC-machined plywood frame. Tops are available in a variety of materials and finishes.

Notes

Nominal dimensions rounded to the nearest 1/2 inch.

Type	Width	Depth	Height
420	16 1/2	13 1/2	21 1/2
620	24 1/2	17 1/2	17 1/2
920	36	22	14

Customer's Own Material (COM) requires the following yardage:

Type	Total
420UP	1
620UP	1
920UP	1 1/2

Customer's Own Leather (COL) requires the following square feet:

Type	Total
420UP	16 1/2
620UP	21 1/2
920UP	27

Dimensions

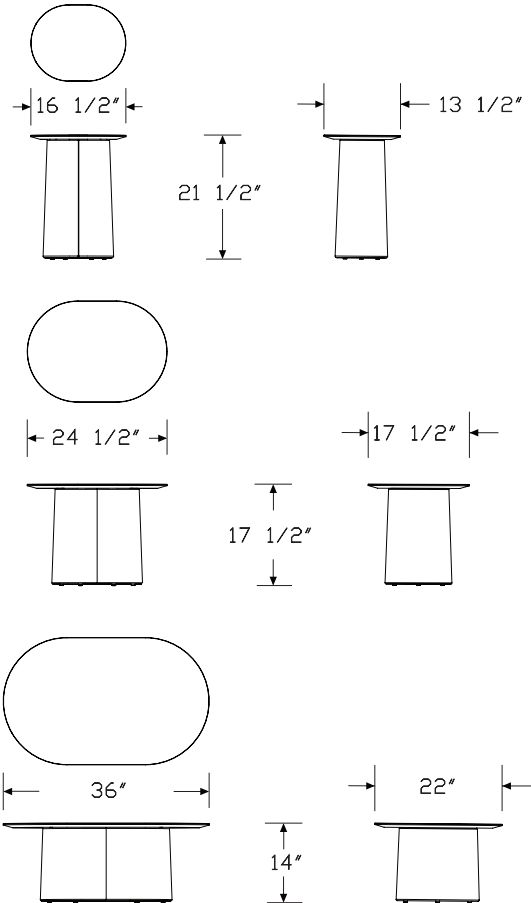

Tun Coffee and Side Tables

continued

NaughtOne Coffee Tables

Specification Information

Step 1.

NOTUN

Step 2. Type

420 side table

620 coffee table

920 low coffee table

Step 3. Base Material

ST steel base

UP upholstered base

Prices for Steps 1-3.

		ST	UP
NOTUN	420	\$1646	1160
	620	\$1724	1376
	920	\$1946	1667

Step 4.

Steel Base Finish

For side table (420), coffee table (620), or low coffee table (920) with steel base (ST)

R00	black RAL 9005 <input type="checkbox"/>	+\$0
R14	signal white RAL9003 <input type="checkbox"/>	+\$0
R02	stone grey RAL 7030 <input type="checkbox"/>	+\$266
R03	silver - RAL 9006 <input type="checkbox"/>	+\$266
R08	traffic orange RAL 2009 <input type="checkbox"/>	+\$266
R13	pastel blue RAL 5024 <input type="checkbox"/>	+\$266
R23	black grey RAL 7021 <input type="checkbox"/>	+\$266
R24	leaf green RAL 6002 <input type="checkbox"/>	+\$266
R25	pale green RAL 6021 <input type="checkbox"/>	+\$266
R26	RAL 3020 red <input type="checkbox"/>	+\$266
R28	light pink RAL 3015 <input type="checkbox"/>	+\$266
R29	dark blue RAL 5001 <input type="checkbox"/>	+\$266
R30	oyster RAL 1013 <input type="checkbox"/>	+\$266
R38	broom yellow RAL 1032 <input type="checkbox"/>	+\$266
R39	moss green RAL 6005 <input type="checkbox"/>	+\$266
R40	steel blue RAL 5011 <input type="checkbox"/>	+\$266

Upholstered Base Fabric

For side table (420) with upholstered base (UP)

Price Category (NaughtOne) 0 <input type="checkbox"/>	+\$0
Price Category (naughtone) 0 <input type="checkbox"/>	+\$0
Price Category (NaughtOne) 1 <input type="checkbox"/>	+\$0
Price Category (naughtone) 1 <input type="checkbox"/>	+\$0
Price Category (NaughtOne) 2 <input type="checkbox"/>	+\$33
Price Category (naughtone) 2 <input type="checkbox"/>	+\$33
Price Category (NaughtOne) 3 <input type="checkbox"/>	+\$64
Price Category (naughtone) 3 <input type="checkbox"/>	+\$64
Price Category (NaughtOne) 4 <input type="checkbox"/>	+\$99
Price Category (naughtone) 4 <input type="checkbox"/>	+\$99
Price Category (NaughtOne) 5 <input type="checkbox"/>	+\$164
Price Category (naughtone) 5 <input type="checkbox"/>	+\$164
Price Category (NaughtOne) 6 <input type="checkbox"/>	+\$230
Price Category (naughtone) 6 <input type="checkbox"/>	+\$230
Price Category (NaughtOne) 7 <input type="checkbox"/>	+\$295
Price Category (naughtone) 7 <input type="checkbox"/>	+\$295
Price Category (NaughtOne) 9 <input type="checkbox"/>	+\$426
Price Category (naughtone) 9 <input type="checkbox"/>	+\$426

Step 5. Upholstered Base Fabric

For coffee table (620) with upholstered base (UP)

Price Category (NaughtOne) 0 <input type="checkbox"/>	+\$0
Price Category (naughtone) 0 <input type="checkbox"/>	+\$0
Price Category (NaughtOne) 1 <input type="checkbox"/>	+\$0
Price Category (naughtone) 1 <input type="checkbox"/>	+\$0
Price Category (NaughtOne) 2 <input type="checkbox"/>	+\$41
Price Category (naughtone) 2 <input type="checkbox"/>	+\$41
Price Category (NaughtOne) 3 <input type="checkbox"/>	+\$81
Price Category (naughtone) 3 <input type="checkbox"/>	+\$81
Price Category (NaughtOne) 4 <input type="checkbox"/>	+\$123
Price Category (naughtone) 4 <input type="checkbox"/>	+\$123
Price Category (NaughtOne) 5 <input type="checkbox"/>	+\$203
Price Category (naughtone) 5 <input type="checkbox"/>	+\$203
Price Category (NaughtOne) 6 <input type="checkbox"/>	+\$283
Price Category (naughtone) 6 <input type="checkbox"/>	+\$283
Price Category (NaughtOne) 7 <input type="checkbox"/>	+\$363
Price Category (naughtone) 7 <input type="checkbox"/>	+\$363
Price Category (NaughtOne) 9 <input type="checkbox"/>	+\$523
Price Category (naughtone) 9 <input type="checkbox"/>	+\$523

Tun Coffee and Side Tables

continued

Step 6. Upholstered Base Fabric		
<i>For low coffee table (920) with upholstered base (UP)</i>		
Price Category (NaughtOne) 0	A	+\$0
Price Category (naughtone) 0	A	+\$0
Price Category (NaughtOne) 1	A	+\$0
Price Category (naughtone) 1	A	+\$0
Price Category (NaughtOne) 2	A	+\$49
Price Category (naughtone) 2	A	+\$49
Price Category (NaughtOne) 3	A	+\$98
Price Category (naughtone) 3	A	+\$98
Price Category (NaughtOne) 4	A	+\$146
Price Category (naughtone) 4	A	+\$146
Price Category (NaughtOne) 5	A	+\$241
Price Category (naughtone) 5	A	+\$241
Price Category (NaughtOne) 6	A	+\$338
Price Category (naughtone) 6	A	+\$338
Price Category (NaughtOne) 7	A	+\$435
Price Category (naughtone) 7	A	+\$435
Price Category (NaughtOne) 9	A	+\$628
Price Category (naughtone) 9	A	+\$628

Step 7. Surface Finish		
<i>For side table (420)</i>		
WRC white MFMDf with reverse chamfer edge	A	+\$0
BRC black MFMDf with reverse chamfer edge	A	+\$0
OAK oak with reverse chamfer edge	A	+\$74
WLN walnut with reverse chamfer edge	A	+\$74
Q23 lino nero 4023 with reverse chamfer edge	A	+\$528
Q32 lino ash 4132 with reverse chamfer edge	A	+\$528
Q55 lino pewter 4155 with reverse chamfer edge	A	+\$528
Q66 lino charcoal 4166 with reverse chamfer edge	A	+\$528
Q72 lino mauve 4172 with reverse chamfer edge	A	+\$528
Q75 lino pebble 4175 with reverse chamfer edge	A	+\$528
Q76 lino mushroom 4176 with reverse chamfer edge	A	+\$528
Q79 lino smokey blue 4179 with reverse chamfer edge	A	+\$528

<i>For coffee table (620)</i>		
WRC white MFMDf with reverse chamfer edge	A	+\$0
BRC black MFMDf with reverse chamfer edge	A	+\$0
OAK oak with reverse chamfer edge	A	+\$275
WLN walnut with reverse chamfer edge	A	+\$275
Q23 lino nero 4023 with reverse chamfer edge	A	+\$672
Q32 lino ash 4132 with reverse chamfer edge	A	+\$672
Q55 lino pewter 4155 with reverse chamfer edge	A	+\$672
Q66 lino charcoal 4166 with reverse chamfer edge	A	+\$672
Q72 lino mauve 4172 with reverse chamfer edge	A	+\$672
Q75 lino pebble 4175 with reverse chamfer edge	A	+\$672
Q76 lino mushroom 4176 with reverse chamfer edge	A	+\$672
Q79 lino smokey blue 4179 with reverse chamfer edge	A	+\$672

<i>For low coffee table (920)</i>		
WRC white MFMDf with reverse chamfer edge	A	+\$0
BRC black MFMDf with reverse chamfer edge	A	+\$0
OAK oak with reverse chamfer edge	A	+\$275
WLN walnut with reverse chamfer edge	A	+\$275
Q23 lino nero 4023 with reverse chamfer edge	A	+\$672
Q32 lino ash 4132 with reverse chamfer edge	A	+\$672
Q55 lino pewter 4155 with reverse chamfer edge	A	+\$672
Q66 lino charcoal 4166 with reverse chamfer edge	A	+\$672
Q72 lino mauve 4172 with reverse chamfer edge	A	+\$672
Q75 lino pebble 4175 with reverse chamfer edge	A	+\$672
Q76 lino mushroom 4176 with reverse chamfer edge	A	+\$672
Q79 lino smokey blue 4179 with reverse chamfer edge	A	+\$672

Step 8. Power Cutout		
<i>For side table (420)</i>		
OCS no cutout	A	+\$0

<i>For coffee table (620)</i>		
OCS no cutout	A	+\$0

<i>For low coffee table (920)</i>		
OCS no cutout	A	+\$0

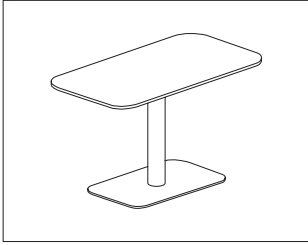

Product Information

Description
 This table has a mild steel tube stem and flat plate steel base finished with polyester powder coat. Tops are available in a variety of materials and finishes. Stem, base and top are delivered unassembled.

Notes

Nominal dimensions rounded to the nearest 1/2 inch.

Type	Width	Depth	Height
10	51	27 1/2	29 1/2

Specification Information

Step 1.

NOHEST1

Step 2. Type

10 standard height rectangular table 1300 x 700

Prices for Steps 1-2.

NOHEST1 10 \$3909

Step 3. Base Finish

R00	RAL 9005 black <input type="checkbox"/>	+\$0
R02	RAL 7030 stone grey <input type="checkbox"/>	+\$402
R03	RAL 9006 silver <input type="checkbox"/>	+\$402
R08	RAL 2009 orange <input type="checkbox"/>	+\$402
R13	RAL 5024 pastel blue <input type="checkbox"/>	+\$402
R14	RAL 9003 white <input type="checkbox"/>	+\$0
R23	RAL 7021 black grey <input type="checkbox"/>	+\$402
R24	leaf green RAL 6002 <input type="checkbox"/>	+\$402
R25	RAL 6021 green <input type="checkbox"/>	+\$402
R26	RAL 3020 red <input type="checkbox"/>	+\$402
R28	RAL 3015 light pink <input type="checkbox"/>	+\$402
R29	RAL 5001 blue <input type="checkbox"/>	+\$402
R30	RAL 1013 oyster <input type="checkbox"/>	+\$402
R38	broom yellow RAL 1032 <input type="checkbox"/>	+\$402
R39	moss green RAL 6005 <input type="checkbox"/>	+\$402
R40	steel blue RAL 5011 <input type="checkbox"/>	+\$402

Step 4. Surface Finish

BRC	black MFMDf top with reverse chamfer edge <input type="checkbox"/>	+\$0
WRC	white MFMDf top with reverse chamfer edge <input type="checkbox"/>	+\$0
OAK	oak veneer top with reverse chamfer edge <input type="checkbox"/>	+\$398
WLN	walnut veneer top with reverse chamfer edge <input type="checkbox"/>	+\$398

Step 5. Cutout

NC no cutout +\$0

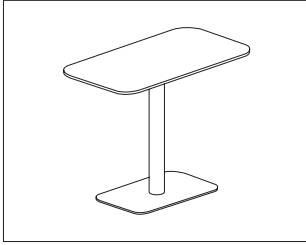

Product Information

Description

This table has a mild steel tube stem and flat plate steel base finished with polyester powder coat. Tops are available in a variety of materials and finishes. Stem, base and top are delivered unassembled.

Notes

Nominal dimensions rounded to the nearest 1/2 inch.

Type	Width	Depth	Height
10	51	27 1/2	39 1/2

Specification Information

Step 1.

NOHEST2

Step 2. Type

10 bar height rectangular table 1300 x 700

Prices for Steps 1-2.

NOHEST2 10 \$4167

Step 3. Base Finish

R00	RAL 9005 black <input type="checkbox"/>	+\$0
R02	RAL 7030 stone grey <input type="checkbox"/>	+\$402
R03	RAL 9006 silver <input type="checkbox"/>	+\$402
R08	RAL 2009 orange <input type="checkbox"/>	+\$402
R13	RAL 5024 pastel blue <input type="checkbox"/>	+\$402
R14	RAL 9003 white <input type="checkbox"/>	+\$0
R23	RAL 7021 black grey <input type="checkbox"/>	+\$402
R24	leaf green RAL 6002 <input type="checkbox"/>	+\$402
R25	RAL 6021 green <input type="checkbox"/>	+\$402
R26	RAL 3020 red <input type="checkbox"/>	+\$402
R28	RAL 3015 light pink <input type="checkbox"/>	+\$402
R29	RAL 5001 blue <input type="checkbox"/>	+\$402
R30	RAL 1013 oyster <input type="checkbox"/>	+\$402
R38	broom yellow RAL 1032 <input type="checkbox"/>	+\$402
R39	moss green RAL 6005 <input type="checkbox"/>	+\$402
R40	steel blue RAL 5011 <input type="checkbox"/>	+\$402

Step 4. Surface Finish

BRC	black MFMDf top with reverse chamfer edge <input type="checkbox"/>	+\$0
WRC	white MFMDf top with reverse chamfer edge <input type="checkbox"/>	+\$0
OAK	oak veneer top with reverse chamfer edge <input type="checkbox"/>	+\$398
WLN	walnut veneer top with reverse chamfer edge <input type="checkbox"/>	+\$398

Step 5. Cutout

NC no cutout +\$0

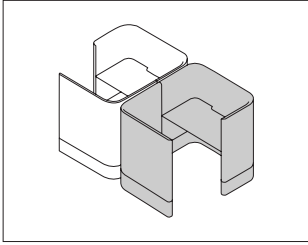

NaughtOne Desks

Product Information

Description
 The Pullman desk and desk pod are upholstered over a plywood inner frame topped with high quality foams. Pullman can be upholstered in a single fabric or multiple fabrics. Desk is specified with an upholstered plinth base. Desktop is CNC cut from white or black melamine-faced medium-density fiberboard, oak or walnut veneer, or forbo lino.

Notes

Desktop comes with scoop cutout at center rear of unit for mounting monitor arms and power options (ordered separately).
 Scoop cutout is 19.7" wide by 2" deep.
 MFMDf and veneer desktops are 1" thick.
 Forbo lino desktops are 1.08" thick.
 Nominal dimensions rounded to the nearest 1/2 inch.

Type	Width	Depth	Height
D00	51	28	51
DPL	51	63	51
DPR	51	63	51

Customer's Own Material (COM) requires the following yardage:

Type	Total	Upper Outer	Plinth
D00	11	8 1/2	2 1/2
DPL	18	15	3
DPR	18	15	3

Specification Information

Step 1.

NOPUL

Step 2. Type

- D00** desk 1200
- DPL** desk pod 1200 - access left
- DPR** desk pod 1200 - access right

Step 3. Upholstery

- 1** single fabric
- 2** multiple fabrics

Prices for Steps 1-3.

		1	2
NOPUL	D00	\$6088	6329
	DPL	\$9547	9867
	DPR	\$9547	9867

Step 4. Surface Finish

- BRC** black MFMDf top with reverse chamfer edge +\$0
- BSE** black MFMDf with edge band +\$0
- WRC** white MFMDf top with reverse chamfer edge +\$0
- WSE** white MFMDf with edge band +\$0
- OKR** oak veneer top with reverse chamfer edge +\$150
- OKE** oak veneer top with edge band +\$150
- WLR** walnut veneer top with reverse chamfer edge +\$150
- WLE** walnut veneer top with edge band +\$150
- Q23** 4023 nero forbo lino top with reverse chamfer edge +\$0
- Q32** 4132 ash forbo lino top with reverse chamfer edge +\$1115
- Q55** 4155 pewter forbo lino top with reverse chamfer edge +\$1115
- Q66** 4166 charcoal forbo lino top with reverse chamfer edge +\$1115
- Q72** 4172 mauve forbo lino top with reverse chamfer edge +\$1115
- Q75** 4175 pebble forbo lino top with reverse chamfer edge +\$1115
- Q76** 4176 mushroom forbo lino top with reverse chamfer edge +\$1115
- Q79** 4179 smokey blue forbo lino top with reverse chamfer edge +\$1115

Step 5. Fabric

For desk 1200 (D00) with single fabric (1)

Price Category (NaughtOne) 0	A	+\$0
Price Category (naughtone) 0	A	+\$0
Price Category (NaughtOne) 1	A	+\$0
Price Category (naughtone) 1	A	+\$0
Price Category (NaughtOne) 2	A	+\$279
Price Category (naughtone) 2	A	+\$279
Price Category (NaughtOne) 3	A	+\$560
Price Category (naughtone) 3	A	+\$560
Price Category (NaughtOne) 4	A	+\$838
Price Category (naughtone) 4	A	+\$838
Price Category (NaughtOne) 5	A	+\$1400
Price Category (naughtone) 5	A	+\$1400
Price Category (NaughtOne) 6	A	+\$1959
Price Category (naughtone) 6	A	+\$1959
Price Category (NaughtOne) 7	A	+\$2519
Price Category (naughtone) 7	A	+\$2519
Price Category (NaughtOne) 9	A	+\$3638
Price Category (naughtone) 9	A	+\$3638

For desk pod 1200 - access left (DPL) or desk pod 1200 - access right (DPR) with single fabric (1)

Price Category (NaughtOne) 0	A	+\$0
Price Category (naughtone) 0	A	+\$0
Price Category (NaughtOne) 1	A	+\$0
Price Category (naughtone) 1	A	+\$0
Price Category (NaughtOne) 2	A	+\$499
Price Category (naughtone) 2	A	+\$499
Price Category (NaughtOne) 3	A	+\$998
Price Category (naughtone) 3	A	+\$998
Price Category (NaughtOne) 4	A	+\$1498
Price Category (naughtone) 4	A	+\$1498
Price Category (NaughtOne) 5	A	+\$2498
Price Category (naughtone) 5	A	+\$2498
Price Category (NaughtOne) 6	A	+\$3499
Price Category (naughtone) 6	A	+\$3499
Price Category (NaughtOne) 7	A	+\$4499
Price Category (naughtone) 7	A	+\$4499
Price Category (NaughtOne) 9	A	+\$6500
Price Category (naughtone) 9	A	+\$6500

Step 6. Upper Outer Fabric

For desk 1200 (D00) with multiple fabrics (2)

Price Category (NaughtOne) 0	A	+\$0
Price Category (naughtone) 0	A	+\$0
Price Category (NaughtOne) 1	A	+\$0
Price Category (naughtone) 1	A	+\$0
Price Category (NaughtOne) 2	A	+\$219
Price Category (naughtone) 2	A	+\$219
Price Category (NaughtOne) 3	A	+\$441
Price Category (naughtone) 3	A	+\$441
Price Category (NaughtOne) 4	A	+\$661
Price Category (naughtone) 4	A	+\$661
Price Category (NaughtOne) 5	A	+\$1104
Price Category (naughtone) 5	A	+\$1104
Price Category (NaughtOne) 6	A	+\$1545
Price Category (naughtone) 6	A	+\$1545
Price Category (NaughtOne) 7	A	+\$1986
Price Category (naughtone) 7	A	+\$1986
Price Category (NaughtOne) 9	A	+\$2869
Price Category (naughtone) 9	A	+\$2869

For desk pod 1200 - access left (DPL) or desk pod 1200 - access right (DPR) with multiple fabrics (2)

Price Category (NaughtOne) 0	A	+\$0
Price Category (naughtone) 0	A	+\$0
Price Category (NaughtOne) 1	A	+\$0
Price Category (naughtone) 1	A	+\$0
Price Category (NaughtOne) 2	A	+\$416
Price Category (naughtone) 2	A	+\$416
Price Category (NaughtOne) 3	A	+\$832
Price Category (naughtone) 3	A	+\$832
Price Category (NaughtOne) 4	A	+\$1248
Price Category (naughtone) 4	A	+\$1248
Price Category (NaughtOne) 5	A	+\$2082
Price Category (naughtone) 5	A	+\$2082
Price Category (NaughtOne) 6	A	+\$2915
Price Category (naughtone) 6	A	+\$2915
Price Category (NaughtOne) 7	A	+\$3749
Price Category (naughtone) 7	A	+\$3749
Price Category (NaughtOne) 9	A	+\$5416
Price Category (naughtone) 9	A	+\$5416

Pullman Desk *continued*

NaughtOne Desks

Step 7. Plinth Fabric

For desk 1200 (D00) with multiple fabrics (2)

Price Category (NaughtOne) 0	A	+\$0
Price Category (naughtone) 0	A	+\$0
Price Category (NaughtOne) 1	A	+\$227
Price Category (naughtone) 1	A	+\$227
Price Category (NaughtOne) 2	A	+\$361
Price Category (naughtone) 2	A	+\$361
Price Category (NaughtOne) 3	A	+\$495
Price Category (naughtone) 3	A	+\$495
Price Category (NaughtOne) 4	A	+\$628
Price Category (naughtone) 4	A	+\$628
Price Category (NaughtOne) 5	A	+\$896
Price Category (naughtone) 5	A	+\$896
Price Category (NaughtOne) 6	A	+\$1165
Price Category (naughtone) 6	A	+\$1165
Price Category (NaughtOne) 7	A	+\$1433
Price Category (naughtone) 7	A	+\$1433
Price Category (NaughtOne) 9	A	+\$1969
Price Category (naughtone) 9	A	+\$1969

For desk pod 1200 - access left (DPL) or desk pod 1200 - access right (DPR) with multiple fabrics (2)

Price Category (NaughtOne) 0	A	+\$0
Price Category (naughtone) 0	A	+\$0
Price Category (NaughtOne) 1	A	+\$302
Price Category (naughtone) 1	A	+\$302
Price Category (NaughtOne) 2	A	+\$315
Price Category (naughtone) 2	A	+\$315
Price Category (NaughtOne) 3	A	+\$434
Price Category (naughtone) 3	A	+\$434
Price Category (NaughtOne) 4	A	+\$553
Price Category (naughtone) 4	A	+\$553
Price Category (NaughtOne) 5	A	+\$791
Price Category (naughtone) 5	A	+\$791
Price Category (NaughtOne) 6	A	+\$1030
Price Category (naughtone) 6	A	+\$1030
Price Category (NaughtOne) 7	A	+\$1267
Price Category (naughtone) 7	A	+\$1267
Price Category (NaughtOne) 9	A	+\$1742
Price Category (naughtone) 9	A	+\$1742



Pullman Whiteboard

NOPUL

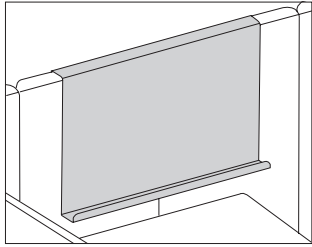

Product Information

Description

The Pullman whiteboard is designed specifically for use with the Pullman booth. It can be moved around the top edge of the entire Pullman booth.

Specification Information

Step 1.

NOPULAWB A

\$500

Index by Product Name

NaughtOne Accessories	
Pullman Whiteboard	page(s) 47
NaughtOne Seating	
Ever Lounge Chair	page(s) 5
Ever Sofa	20
Hue 2 Seat Sofa	23
Penny Stools	29
Percy Lounge Chair	7
Pippin Lounge Chair	9
Pippin Replacement Cover	11
Pippin Replacement Strap Handle	12
Pullman Booth	30
Pullman Chair	13
Pullman Chair Pod	16
Pullman Sofa	26
NaughtOne Tables	
Hue Bar Height Table	page(s) 41
Hue Standard Height Table	40
Pullman Desk	42
Tun Coffee and Side Tables	37



Index by Product Number

NOEVE	Ever Lounge Chair	page(s) 5
NOEVE	Ever Sofa	20
NOHES	Hue 2 Seat Sofa	23
NOHES	Hue Bar Height Table	41
NOHES	Hue Standard Height Table	40
NOPEN	Penny Stools	29
NOPIP	Pippin Lounge Chair	9
NOPIP	Pippin Replacement Cover	11
NOPIP	Pippin Replacement Strap Handle	12
NOPRC	Percy Lounge Chair	7
NOPUL	Pullman Booth	30
NOPUL	Pullman Chair	13
NOPUL	Pullman Chair Pod	16
NOPUL	Pullman Desk	42
NOPUL	Pullman Sofa	26
NOPUL	Pullman Whiteboard	47
NOTUN	Tun Coffee and Side Tables	37



GSA

Price Category 1

Camira Mainline Flax
Maharam Article
Maharam Lariat
Maharam Meld
Maharam Metaphor
Maharam Mode
Maharam Muse

Price Category 2

Camira Blazer
Herman Miller Terra
Maharam Manner
Maharam Merit
Maharam Messenger
Maharam Murmur
Maharam Nico
Herman Miller Crossing

Price Category 3

Camira Hemp
Camira Silk
Camira Synergy
Herman Miller Cozy
Maharam Metric
Herman Miller Crepe
Momentum Canter

Price Category 4

Maharam Beck
Maharam Compound
Maharam Instill
Ultrafabrics Brisa Original
Ultrafabrics Ultraleather

Price Category 5

Kvadrat Canvas
Kvadrat Remix
Maharam Gemma
Maharam Luce
Maharam Plait
Herman Miller Hopsak

Price Category 6

Maharam Campana
Kvadrat Steelcut
Kvadrat Steelcut Trio
Maharam Brim
Maharam Gemma Multi
Maharam Sudden

Price Category 7

Maharam Pace Leather

Price Category 8

Price Category 9

For more information about our products and services or to see a list of dealers, please visit us at HermanMiller.com or call (800) 851 1196.

© 2024 Herman Miller, Inc., Zeeland, Michigan

Distribution Rights

Working together since 1956, Herman Miller and Vitra are the authentic sources of designs by Charles and Ray Eames, Alexander Girard, and George Nelson. All the designs shown in this book are protected by law. Herman Miller has obtained all rights to make and sell these designs. Also, Herman Miller holds exclusive worldwide manufacturing and distribution rights for these products with the following exceptions:

Charles and Ray Eames, George Nelson, and Alexander Girard—Worldwide distribution rights for furniture in all areas except Europe and the Middle East. For those areas, please contact Vitra.

Isamu Noguchi—Worldwide distribution rights for the Noguchi Rudder Table. Distribution rights for the Noguchi Table in North America and Central America only. For all other areas, please contact Vitra.

Magis—Exclusive distribution rights in the US and Canada. For all other areas, please contact Magis.

© **HermanMiller**, , Action Office, Aeron, Aside, Canvas Office Landscape, Caper, Cosm, Co/Struc, Eames, Embody, Ethospace, Exclave, Fine-Tune, FlexFront, Formcoat, Ground Cloth, Intent, Layout Studio, Lino, Maharam, Meridian, Mirra, Motia, Nelson, Pellicle, Perspectives, Plex, PostureFit, PostureFit SL, Sayl, Setu, Tu, Verus, Y-Tower and Zeph are among the registered trademarks of Herman Miller, Inc., and its owned subsidiaries.

™ AireWeave, Bubbletack, Canvas Vista, Cellular Suspension, Commend, Compass, Connect, DOT, Durawrap, Everywhere, Flex-Edge, Headway, Hopsak 2, Iota, Keyless Entry, Latitude, Lyris 2, Mora, Multiscrim, Nevi, OE1, OE1 Workspace Collection, Overlay, Renew, Stackable, Swoop, Thrive, TriFlex, Twist and Valor are among the trademarks of Herman Miller, Inc., and its owned subsidiaries.

Chemsurf® is a registered trademark of Wilsonart International.

Corian® is a registered trademark of E.I. du Pont de Nemours and Company Corporation.

FLEXNET™ is a trademark of Milliken & Company.

Floor Saver Glide® is a registered trademark of Carpin Manufacturing, Inc.

Forest Stewardship Council® is a registered trademark of the Forest Stewardship Council A.C. (FSC). We are FSC® certified (FSC® C102895).

FSC® is a registered trademark of the Forest Stewardship Council A.C. (FSC).

MicrobeCare™ is a trademark of Parasol Medical LLC.

Microsoft® and Natural® Keyboard are registered trademarks of Microsoft Corporation.

Place Textiles® is a registered trademark of Place Textiles.