



GSA prices effective October 7, 2024  
(based on July 1, 2024, commercial price list)  
Published October 2024

## Multipurpose Seating

### Asari Chair by Herman Miller™

#### **General Services Administration Federal Supply Service Authorized Federal Supply Schedule Price List**

Online access to contract ordering information, terms and conditions, up-to-date pricing, and the option to create an electronic delivery order is available through GSA Advantage!®, a menu-driven database system.

The Internet address for GSA Advantage! is [www.gsaadvantage.gov](http://www.gsaadvantage.gov).

Office Furniture  
FSC/PSC 7110/7125  
Contract Number: GS-03F-036DA  
UEI: Q2K3MSZ843D8  
Contract Period: December 21, 2015—December 20, 2025

MillerKnoll, Inc.  
855 East Main Avenue  
Zeeland, Michigan 49464  
(616) 654 3000 Phone  
(616) 654 8278 Fax  
[www.HermanMiller.com/government](http://www.HermanMiller.com/government)

Business Size: Large



# Contract Information

## 1a. Special Item Numbers (SIN)

SIN 33721

Furniture Systems, Computer Furniture, Filing and Storage, Tables and Accessories, Upholstered Seating and Multi-Purpose Seating, Project Management, Reconfiguration and Relocation Services, Design/Layout and Installation Services

SIN 33721P

Packaged Offices

SIN 337127

Modular Laboratory Furniture Systems

SIN 339113H

Healthcare Furniture

SIN OLM

Order-Level Materials (OLMs)

This SIN is only for products and/or services used in direct support of the purchase of new furniture. It requires approval from the ordering Contract Officer. Please contact your local MillerKnoll Inc. representative to discuss the appropriate use of this SIN.

SIN 532289

Leasing

Contact MillerKnoll Inc participating government dealer for current leasing information.

## 1b. Lowest Priced Model

SIN 33721:	BVP3.S	\$7.27
SIN 33127:	TW113	\$5.81
SIN 339113H:	CR900NR	\$483.80

## 1c. Service Rates

Project Management

Furniture Project Manager: \$64.75 per hour  
 Furniture Project Coordinator: \$49.00 per hour  
 Build-Out Project Manager: \$80.00 per hour

Reconfiguration and Relocation Services

Not to exceed \$55 per hour.

See \* Additional Notes for Installation & Reconfiguration and Relocation Services.

Design/Layout

Not to exceed \$65 per hour.

Installation Services

Not to exceed \$55 per hour (\$82.50 per hour for after-hours Installation).

See \* Additional Notes for Installation & Reconfiguration and Relocation Services.

## 2. Maximum Order

SIN 33721, 337127, NEW, OLM

\$250,000 net product value

SIN 33721P

\$250,000 net value

SIN 339113H

\$500,000 net product value

## 3. Minimum Order

\$100 net

## 4. Geographic Coverage

Continental U.S.

Orders for Alaska, Hawaii, and Puerto Rico will be shipped F.O.B. inland carrier point of exportation.

## 5. Point of Production

Zeeland, Ottawa County, Michigan

Spring Lake, Ottawa County, Michigan

Elland, Yorkshire, United Kingdom

Hildebran, Burke County, North Carolina, USA

## 6. Pricing

Prices shown are list. Discounts include Industrial Funding Fee.

SIN 33721

Standard Lead Time, Single Order Net Purchase \$100 - 250,000, includes approved Herman Miller Options Products.

Product Line	Discount From List
Action Office 1	73.8%
Action Office 2	73.8%
Aeron	64.5%
Ambit Workspace Solutions	74.3%
Asari Chair	53.7%
Aside	64.2%
C-Style Overhead Storage	73.8%
Canvas Office Landscape Channel	74.8%
Canvas Office Landscape Dock	74.8%
Canvas Metal Desk	74.8%
Canvas Office Landscape Metal Storage	74.8%
Canvas Office Landscape Private Office	74.8%
Canvas Office Landscape Wood Storage	74.8%
Canvas Office Landscape Vista	74.8%
Canvas Office Landscape Wall	74.8%
Caper	61.5%
Commend Nurses Station	73.3%
Cosm	61.7%
Eames® Aluminum Group	58.7%
Eames Conference & Dining Tables	73.6%
Easton Family	54.91%
Embody	59.7%
Energy Distribution Systems	73.8%
Ethospace System	73.8%
Everywhere™ Tables	73.8%
Exclave	61.7%

# Contract Information

continued

Fuld	59.7%
Headway™ Tables	73.8%
Intent Solution	58.7%
Layout Studio®	60.7%
Lighting	73.8%
Lino	63.7%
Meridian Laterals	67.3%
Meridian Pedestals	64.2%
Meridian Towers	62.7%
Meridian Storage	62.7%
Mirra 2	61.7%
Motia Tables	73.8%
NaughtOne	50.0%
Nemschoff	54.91%
Nevi™ Tables	73.8%
Nevi Link	73.8%
OE1 Boundary	72.8%
OE1 Community Elements	61.7%
OE1 Micro Packs	73.8%
OE1 Storage	72.8%
OE1 Tables and Benching	73.8%
Overlay™	62.7%
Plex® Lounge Furniture	59.5%
Public Office Landscape	61.7%
Renew™ Tables	73.8%
Renew Link	73.8%
Sayl	62.2%
Setu	59.7%
Swoop Lounge Furniture	60.7%
Thrive Portfolio	62.0%
Thrive Portfolio-CBS Products Extension	62.0%
Tu Lateral Files	74.3%
Tu Pedestals	73.8%
Tu Storage	74.3%
Tu Towers	74.3%
Tu Wood Cases	74.3%
Tu Wood Cubbies	74.3%
Tu Wood Credenzas	74.3%
Tu Wood Pedestals	74.3%
Tu Wood Towers	74.3%
Valor™ Family	54.91%
Verus	63.7%
Zeph	60.2%

## Services

Please refer to section 19 for Terms and Conditions of Installation/ Reconfiguration and Relocation Services.

## Project Management

Services under this SIN may be used only in conjunction with the purchase of new furniture. Please contact your local MillerKnoll Inc. representative to discuss the available labor categories (listed below). The hourly rates listed are “Not To Exceed” or “NTE” values.

Furniture Project Manager: \$64.75 per hour  
 Furniture Project Coordinator: \$49.00 per hour  
 Build-Out Project Manager: \$80.00 per hour

## Reconfiguration and Relocation Services

Reconfiguration and Relocation Services will be provided by MillerKnoll Inc. or its participating dealer based on a fee not to exceed \$55 per hour.

See \* Additional Notes for Installation & Reconfiguration and Relocation Services.

## Design/Layout

Design service will be provided by MillerKnoll Inc. or its participating dealer based on a fee not to exceed \$65 per hour.

## Installation Services

Installation Services will be provided by MillerKnoll Inc. or its participating dealer based on a fee not to exceed \$55 per hour (\$82.50 per hour for after-hours Installation).

See \* Additional Notes for Installation & Reconfiguration and Relocation Services.

## SIN 337127

Standard Lead Time, Single Order Net Purchase \$100 - 250,000, includes approved Herman Miller Options Products.

Product Line	Discount From List
Action Lab	58.5%
Compass System	58.5%
Co/Struc System	58.5%
Healthcare Carts	18.0%
Mora System	58.5%
Bedside Cabinets	58.5%

## SIN 33721P

Packaged Office Furniture - Maximum Order \$250,000 (net).

Includes packaged furniture solutions for customers needing to furnish an office.

## SIN 339113H

Standard Lead Time, Single Order Net Purchase \$100 - 500,000, includes approved Herman Miller Options Products.

Product Line	Discount From List
Nemschoff Healthcare Furniture	54.91%

## 7. Quantity Discounts

Reference item #6.

## 8. Payment Terms

Net 30 days

## 9. Foreign Items

None

## 10. Time of Delivery

- 90 day ARO
- Expedited delivery: Items listed in the 10-Day section of the catalogs are available for expedited delivery.
- Overnight/2-day delivery: Select items may be available for overnight or 2-day delivery. Contact MillerKnoll Inc. or a participating dealer for availability and rates.
- Urgent requirements: Agencies may contact contractor or participating dealer to request faster delivery.

# Contract Information

continued

## 11. F.O.B.

F.O.B. destination except Alaska, Hawaii, and Puerto Rico, which will be shipped F.O.B. inland carrier point of exportation.

## 12. Ordering Address

a. MillerKnoll Inc.

Government Customer Care 0161

855 East Main Avenue

Zeeland MI 49464.

b. For supplies and services, the ordering procedures information on Blanket Purchase Agreements (BPA's) are found in Federal Acquisition Regulation (FAR) 8.405-3.

## 13. Payment Address.

MillerKnoll Inc.

22764 Network Place

Chicago, IL 60673-1227

## 14. Warranty

MillerKnoll Inc. commercial warranty applies.

## 15. Export Packing Charge

Prices supplied on request.

## 16. Rental Maintenance and Repair Terms

Not applicable

## 17. Terms and Conditions of Installation/Reconfiguration and Relocation Services

\* Additional Notes for Installation & Reconfiguration and Relocation Services:

FOB Destination (Drop Ship): Price includes product delivery to the site, brought to the tailgate of the truck. The purchaser is responsible for unloading.

Prices effective up to the maximum order by SIN only. Above the MO, pricing shall be negotiated on a case-by-case basis between the client and local dealer.

Standard Services are Subject to the Following Conditions:

Installation will be performed during normal weekday working hours.

Adequate facilities for delivery, unloading, moving and staging/storing the product during the installation process shall be provided.

Service work will not be hindered by other trades.

Electric, heat, and adequate elevator service will be furnished without charge.

The immediate installation area shall be complete and free of debris including the carpet/flooring before installation commences.

Any work requiring a licensed electrician is the responsibility of the buyer.

Additional Charges May Apply For:

Major Metro Markets and any non-ground floor installation.

Major Metro Markets include large population centers and urban environments.

Installation in a clinical/medical environment.

Special restrictions or limits established by local laws, ordinances or the directions of the buyer, including but not limited to restrictions on transportations of materials, street access to the job site and/or dock facilities.

Installations outside of a 50 mile radius of the servicing dealer.

Local Prevailing Wage and/or Union Labor Rates.

Any additional charges shall be quoted by the dealer and approved by the buyer prior to performance of the work.

## 18. Terms and Conditions of Repair Parts

Not applicable

## 19. Service and Distribution Points

For service and distribution points nearest you, call (800) 851 1196.

## 20. Participating Dealers

Access Herman Miller web site for current list of participating dealers: [www.HermanMiller.com/where-to-buy/contact-a-dealer/](http://www.HermanMiller.com/where-to-buy/contact-a-dealer/). Select your market by using the filter.

## 21. Preventive Maintenance

Not applicable

## 22a. Special Attributes.

2022

MillerKnoll earns its 15th consecutive perfect score in Human Rights Campaign Foundation's 2022 Corporate Equality Index.

2021

The OE1 Trolley and Micro Packs are both winners of the 2021 Archiproductions international design competition in the Office Category.

MillerKnoll is named to Michigan's Best and Brightest in Wellness List for 2021.

MillerKnoll is awarded Platinum Rating in CSR by EcoVadis.

OE1 is named winner of Wallpaper's "Most Futuristic Furniture" Category as part of their first-ever Smart Space Awards.

OE1 receives the Workplace category award from Fast Company's 2021 Innovation by Design Awards.

MillerKnoll is named to Fast Company's Annual List of the World's Most Innovative Companies for 2021.

MillerKnoll is recognized as a "Disclosure Leader" by the Chemical Footprint Project (CFP).

# Contract Information

*continued*

MillerKnoll earns its 14th consecutive perfect score in Human Rights Campaign Foundation's 2021 Corporate Equality Index.

MillerKnoll is named to Newsweek's List of America's Most Responsible Companies 2021.

Great Lakes Women's Business Council awards MillerKnoll for "Excellence in Supplier Diversity" in the Best In Class category.

2020

Herman Miller is recognized with a 2020 FSC® Leadership Award for our commitment to responsible forestry management.

Herman Miller is named one of Investor's Business Daily Top 50 Best ESG (Environmental, Social, and Corporate Governance) Companies.

Working Mother names Herman Miller as one of the Best Companies for Dads.

Herman Miller is awarded Platinum Rating in CSR by EcoVadis.

Herman Miller is named Diversity Inc 2020 Noteworthy Company for recruitment efforts, employee development opportunities, leadership accountability, and supplier diversity.

Cosm, by Studio 7.5, receives an iF Gold Award in the Office and Industry category at the iF World Design Awards 2020.

Herman Miller earns its 13th consecutive perfect score in Human Rights Campaign Foundation's 2020 Corporate Equality Index.

2019

Mora System casework, designed by Collective Ten for Herman Miller, receives silver in the Industrial and Life Science Design/Medical Furniture category at the European Product Design Awards.

Mora System casework is awarded GOOD DESIGN Award 2019, selected for design excellence and innovation.

National Minority Supplier Diversity Council (NMSDC) names Herman Miller as the 2019 Class 1 Corporation of the Year for leadership in supplier diversity.

TIME Magazine names Cosm to its list of 100 Best Inventions of 2019.

Herman Miller is named #12 Overall and #2 in Manufacturing on Investor's Business Daily Best ESG (Environmental, Social, Governance) Companies.

Herman Miller is recognized as a silver level Certified Veteran-Friendly Employer by the Michigan Veterans Affairs Agency for a commitment to veteran hiring, retention, and development.

For the second year in a row, Herman Miller receives a Gold Medal from EcoVadis in recognition of Corporate Social Responsibility achievement measured in categories of environment, labor and human rights, ethics, and sustainable procurement.

Herman Miller is named "Frontrunner" in Chemical Footprint Project by Clean Production Action for our chemical management policies and practices.

Herman Miller receives International Interior Design Association and Contract's best showroom design award in the "Large Showroom" category at NeoCon.

Herman Miller earns its 12th consecutive perfect score in Human Rights Campaign Foundation's 2019 Corporate Equality Index.

Cosm, designed by Studio 7.5 for Herman Miller, receives a Red Dot Best of the Best Product Design Award in the "Office Chairs" category.

Lino, designed by Sam Hecht and Kim Colin for Herman Miller, receives an iF Design Award in the Product Design category.

2018

Overlay, designed by Birsell+Seck, receives Interior Design Best of Year Award in the Partitions and Wall Systems category.

Herman Miller receives the "Corporation of the Year" in consumer products award from the Michigan Minority Supplier Development Council.

Herman Miller achieves the Advanced Excellence in Supplier Diversity Award from the Great Lakes Women's Business Council for doing business with women-owned suppliers.

Great Lakes Women's Business Council awards Herman Miller for "Excellence in Supplier Diversity" in the Advanced category.

WEConnect awards Herman Miller an Honorable Mention for global supplier diversity initiatives.

As one of the top-scoring companies in the industry for the 14th consecutive year, Herman Miller has qualified for inclusion in RobecoSAM's 2018 Sustainability Yearbook and receives the Silver Class distinction for excellent sustainability performance—economic, environmental, and social.

For the 11th consecutive year, Herman Miller receives a perfect score on the Human Rights Campaign Foundation's Corporate Equality Index and is designated as Best Place to Work for LGBT equality. This report evaluates U.S. companies in terms of diversity, particularly LGBT-related policies and practices.

# Contract Information

*continued*

Herman Miller receives Gold Medal from EcoVadis in recognition of Corporate Social Sustainability achievement measured in categories of environment, labor and human rights, ethics, and sustainable procurement. EcoVadis operates the first web-based collaborative platform that allows companies to assess the environmental and social performance of their global suppliers.

Aeron receives Good Design Award from The Chicago Athenaeum Museum of Architecture and Design.

The Cosm Chair wins Mix Interiors “Product of the Year—Task” award.

2017

Herman Miller receives “Rising Star Award” from the Michigan Veterans Affairs Agency (MVAA) for exhibiting new and novel approaches to veteran recruitment and hiring.

Herman Miller is named the 2017 “Corporation of the Year” in the consumer products sector by the Michigan Minority Supplier Development Council (MMSDC).

Herman Miller receives a 2017 SEAL (Sustainability, Environmental Achievement and Leadership) Business Sustainability Award. SEAL Award winners are determined by a holistic methodology measuring applicants against established benchmarks that demonstrate impact and progress toward creating a healthy planet and a sustainable future.

Herman Miller earns the 4 Star Diversity Visionary Award. This award celebrates the diversity, equality, and inclusion work of Herman Miller. The award is presented at the annual Diversity Equity Inclusion Summit, held by the Grand Rapids Area Chamber of Commerce.

Herman Miller is named one of the Best and Brightest in Wellness for the 5th year in a row.

Herman Miller earns its 10th consecutive perfect score in Human Rights Campaign Foundation’s 2017 Corporate Equality Index.

As one of the top-scoring companies in the industry for the 13th consecutive year, Herman Miller has qualified for inclusion in RobecoSAM’s 2017 Sustainability Yearbook and receives the Bronze Class distinction for excellent economic, environmental, and social sustainability performance. The selection criteria for inclusion in the Yearbook becomes more rigorous each year, and only the top 15 percent of companies within each industry are selected.

Herman Miller once again earns the WorldatWork Seal of Distinction, a unique standard of excellence in work-life effectiveness that shows we provide a distinct, mutually beneficial workplace experience. Herman Miller is the only furniture manufacturer among the 160 companies across the U.S. and Canada honored with the award.

Herman Miller’s Mora wins Nightingale Silver Award in the “Furniture Collections” category at the 2017 Healthcare Design Conference.

2016

Herman Miller earns 9th consecutive perfect score in Human Rights Campaign Foundation’s Corporate Equality Index and is designated as Best Place to Work for LGBT equality.

Herman Miller is recognized as the Business of the Year at the Annual Meeting of the West Michigan Environmental Action Council (WMEAC) for being an outstanding partner in support of the growth of WMEAC’s programs. WMEAC’s award goes to the business with the greatest depth and breadth of support, unwavering dedication to environmental action in West Michigan, and a strong corporate commitment to environmental advocacy.

The 101 Best and Brightest Sustainable Companies once again (5th consecutive year) recognizes Herman Miller as an organization in Michigan (and for the first time, in the nation) that exhibits leadership and innovation in its approach to sustainability. This award celebrates those companies that are making their businesses more sustainable, the lives of their employees better, and the community, both locally and globally, more responsible as a whole.

Herman Miller is recognized by the Michigan Minority Supplier Development Council (MMSDC) as a “Corporation of the Year”. Additionally, we are the only West Michigan company this year to receive an “Ambassadors Championing Excellence” Award from the MMSDC.

Herman Miller is recognized with “2016 Excellence in Supplier Diversity Award” from the Great Lakes Women’s Business Council.

Herman Miller is recognized as a 2016 Healthiest 100 Workplace in America, ranking 49th in the country for our commitment to health and exceptional corporate wellness programming.

Herman Miller receives the Best and Brightest in Wellness Award for the 4th year in a row. This program is an innovative initiative that recognizes and celebrates quality and excellence in health awareness.

The Michigan Occupational Safety and Health Administration renews Herman Miller’s “Star” status, the highest workplace safety and health designation, for the Hickory facility in Spring Lake.

Plex Lounge Furniture from Herman Miller receives #MetropolisLikes award at NeoCon 2016.

Plex Lounge Furniture from Herman Miller receives Interior Design HIP Award for Workplace Seating/Lounge at NeoCon 2016.

Herman Miller is named a 2016 Women on Boards Winning Company. Companies selected for this recognition are considered champions of board diversity as 20 percent or more of their board seats are occupied by women.

Herman Miller is selected for inclusion in the 2016 RobecoSAM Sustainability Yearbook for the 12th consecutive year.

Herman Miller again earns the WorldatWork Work-Life 2016 Seal of Distinction. This award identifies organizations that focus on programs that promote work-life balance and overall well-being.

# Contract Information

*continued*

## **22b. Section 508 Compliance**

Not applicable

## **23. Unique Entity ID:** Q2K3MSZ843D8

## **24. Registered in System for Award Management ([www.SAM.gov](http://www.SAM.gov)) Database**

## **25. Cancellation**

Prior to production, no cancellation charge will apply. After production, only actual cost incurred that the contractor can demonstrate if items are sold after 3 months.

## **26. Restocking Charges**

Agencies must notify the contractor for authorization prior to returning any items. The customer agency will be required to pay all packaging and return freight charges. A restocking fee of 50% for Systems Furniture and 35% for all other product lines will be charged for any returned items.

Returns and restocking policy is not applicable to Options products, products under SIN 337127, 339113H, NaughtOne and Nemschoff products.

## **MillerKnoll Inc. Miscellaneous Information:**

Federal ID Number: 38-0837640

Commercial and Government Entity Code (CAGE): 40636

Data Universal Numbering System (DUNS) 00-601-2801

Commercial Entity Code (CEC): 00702290



---

<b>Introduction</b>	<b>page 2</b>
<b>Asari Chair by Herman Miller™</b>	<b>3</b>
Work Chair, Fully Assembled	5
Work Chair, Color Flood, Fully Assembled	7
Arm Kit	9
<b>Appendices</b>	
20-Day or Less/Assigned Lead-Time Order Information	
Casters and Glides	
Textiles Application Chart-Seating	
Textile Colors	
<b>For the latest materials information, refer to the Materials pages on <a href="http://HermanMiller.com">HermanMiller.com</a>.</b>	

# Introduction

## A Note on the Organization of This Book

There are a few signals that will help you understand the organization of this book. Once you know them, you should be able to find your way around easily.

### Like a newspaper, this book is formatted with columns of text and illustrations that run vertically.

Information wraps from one column to the next and continues for as many pages as it needs to.

### Black bars are clues.

A black bar at the top of a page signals the start of information about a product.

This information is divided into two sections, each signaled by a black bar. Product Information includes a description, additional notes, and dimensional drawings. Specification Information, which always begins at the top of a column, includes a series of steps. Each step represents a decision you need to make in order to complete your product number. Steps must be followed sequentially. The number of pages needed to complete information on a product varies; some will be complete in one page; others may fill three or four pages. Just continue going through the steps until you run into the next product, signaled by the black bar at the top of the page.

Black tabs running along the outside edge of the page help you locate what section you are in or what section you want to go to. You can thumb forwards or backwards to find a section; tabs and text appear on both sides of the page.

The additional pages in the back of the book include the appendices and indices. They are signaled by a long black bar running along the outside edge of the page.

### The index is presented two ways.

The first index is in alphabetical order by product name. It can be helpful if you are new to the products and numbering scheme or if you are looking for a type of product, such as work chair or round table.

The second index is by product number. It lists, in alphanumeric order, the base product number, typically a five-digit number.

## General Information

This book is effective October 7, 2024, subject to change without notice. Products may be purchased from authorized Herman Miller dealers who will quote prices upon request. For more information about our products and services or to see a list of dealers, visit [www.HermanMiller.com](http://www.HermanMiller.com).

All prices are list prices. Additional services, such as planning services, design, storage, and installation, are not included and must be added to these prices when the additional services are requested.

Illustrations, specifications, and prices are based on the latest information at the time of publication. The right is reserved to make changes at any time without notice in prices, fabrics, finishes, materials, specifications, and models, and also to discontinue models and finishes.

Dimensions shown in the drawings are engineering drawing dimensions rounded up to the nearest  $\frac{1}{8}$ ". Product is shipped set up or knocked down. Products that include "Shipped knocked down" in the description require some assembly. If this statement does not appear in the description, the product is shipped assembled.

Service problems are normally handled by a Herman Miller authorized dealer. Where this cannot be accomplished on a local level, service problems should be referred to the Customer Care Representative for your region, Herman Miller, Inc., Zeeland, Michigan 49464.

### 20-Day or Less/Assigned Lead-Time Shipments

All products and options in this price book not designated by an Assigned Program icon  will ship in **20 business days or less** after being acknowledged by Herman Miller.

Products and options designated by an  are on the assigned lead-time program and may ship in 20 days, less than 20 days, or more than 20 days from order acknowledgement.





# Asari Work Chair, Fully Assembled

NU1GN

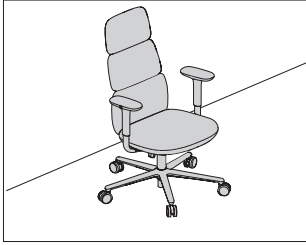

## Product Information

### Description

This chair is a fully-upholstered, minimally-adjustable work chair with integrated passive lumbar and sacral support and 1 standard height adjustment. The self-adjusting synchronous tilt is tuned to provide automatic support. High-back chair provides support up to the upper thoracic region while the mid-back chair provides support up to the scapular region. Arm options are no arms, fixed arms, and height-adjustable arms with vertical movement of 100mm. Frame and base finish can be coordinated with fabric to form a flood of color from top of chair to base within the NU3 product number. For more variety, the chair can be specified with Alpine or Graphite frame and base finish with 1 of the approved fabric options within the NU1 product number.

### Notes

Nonupholstered armpads are color matched to base/frame selection of Alpine or Graphite. Leather armpads are available in 5 select Stow Leather colors: Jettison (ZSV05), Raven (ZSV26), Heron (ZSV35), Zone (ZSV23), and Rime (ZSV28).

Select materials available on 20-day lead-time.

Customer's Own Material (COM) is not offered on this chair.

As with any material or textile, dye transfer may occur on seating surfaces, being more noticeable on lighter color expressions. If this is a concern, we recommend selecting a darker color expression on which dye transfer will be less noticeable. As a reminder, dye transfer is not covered under the Herman Miller warranty.

For information on casters and glides, see Casters and Glides in appendices.

## Dimensions

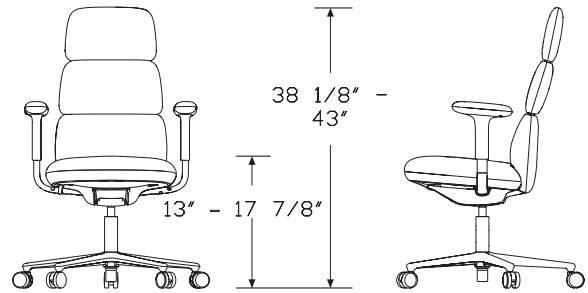
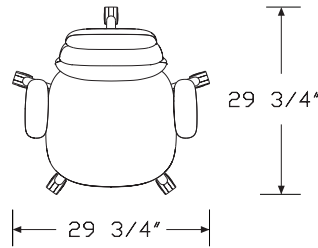

Low height

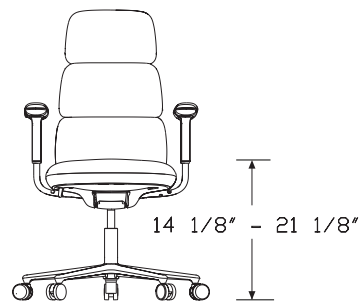

Standard height

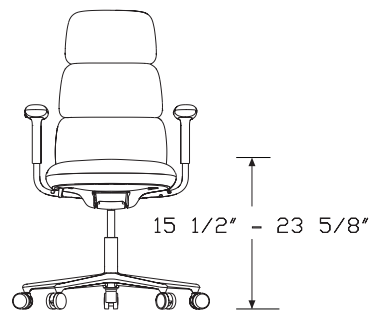

Extended height

# Asari Work Chair, Fully Assembled *continued*

Specification Information		
Step 1.		
<b>NU1</b>		
Step 2. Region Code		
<b>GN</b>	global standard compliant	+\$0
Step 3. Back Height		
<b>5</b>	mid back height	+\$1927
<b>6</b>	high back height	+\$1979
Step 4. Height Adjustment		
<b>1</b>	low-height range	+\$0
<b>2</b>	standard-height range	+\$0
<b>3</b>	extended-height range	+\$52
Step 5. Tilt		
<b>4</b>	self-adjusting synchronous tilt	+\$0
Step 6. Arms		
<b>N</b>	no arms	+\$0
<b>P</b>	fixed arms	+\$123
<b>H</b>	height-adjustable arms	+\$205
Step 7. Armpad Upholstery		
<i>For no arms (N)</i>		
<b>N</b>	no arms	+\$0
<i>For fixed arms (P) or height-adjustable arms (H)</i>		
<b>W</b>	nonupholstered armpads	+\$0
<b>F</b>	leather armpads	+\$154
Step 8. Seat-Depth Adjustment		
<b>F</b>	fixed seat depth	+\$0
Step 9. Base/Frame Finish		
<b>G1</b>	graphite (CP)	+\$0
<b>ZM</b>	alpine	+\$0
Step 10. Armpad Finish		
<i>For nonupholstered armpads (W) with graphite (CP) (G1)</i>		
<b>G1</b>	graphite (CP)	+\$0
<i>For nonupholstered armpads (W) with alpine (ZM)</i>		
<b>ZM</b>	alpine	+\$0

Step 11. Casters/Glides		
<b>BB</b>	2 1/2" hard caster, black yoke, carpet	+\$0
<b>C7</b>	2 1/2" caster, black yoke, hard floors	+\$50
Step 12. Fabric		
	Price Category 3	+\$64
	Price Category 8	+\$415
	Price Category R	+\$992
Step 13. Armpad Leather		
<i>For leather armpads (F)</i>		
	Price Category R	+\$70

Asari Work Chair, Color Flood, NU3GN  
Fully Assembled



**Product Information**

**Description**

This chair is a fully-upholstered, minimally-adjustable work chair with integrated passive lumbar and sacral support and 1 standard height adjustment. The self-adjusting synchronous tilt is tuned to provide automatic support. High-back chair provides support up to the upper thoracic region while the mid-back chair provides support up to the scapular region. Arm options are no arms, fixed arms, and height-adjustable arms with vertical movement of 100mm. Frame and base finish can be coordinated with fabric to form a flood of color from top of chair to base within the NU3 product number. For more variety, the chair can be specified with Alpine or Graphite frame and base finish and 1 of the approved fabric options within the NU1 product number.

**Notes**

Armpad finish is matched with base/frame finish. For nonupholstered armpads (W), armpad finish is color-matched for Alpine (ZM), Cocoa (CC1), Canyon (DR1), Graphite (G1), Marigold (RLD), and Peacock (PBL). For leather armpads (F), leather is color-coordinated for Black (BK) and Nightfall (DN2).

Select materials available on 20-day lead-time.

Customer's Own Material (COM) is not offered on this chair.

As with any material or textile, dye transfer may occur on seating surfaces, being more noticeable on lighter color expressions. If this is a concern, we recommend selecting a darker color expression on which dye transfer will be less noticeable. As a reminder, dye transfer is not covered under the Herman Miller warranty.

For information on casters and glides, see Casters and Glides in appendices.

**Dimensions**

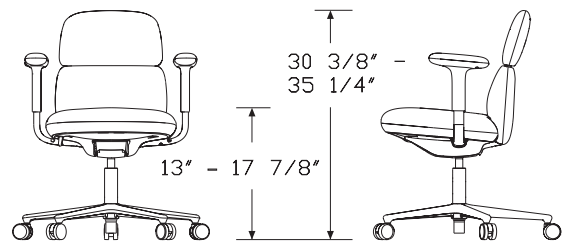
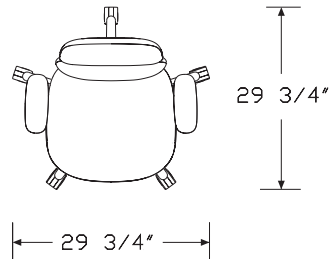

Low height

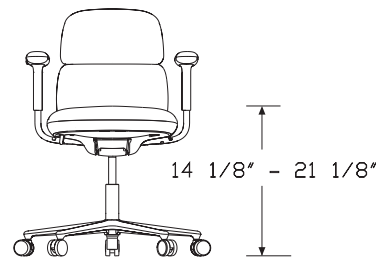

Standard height

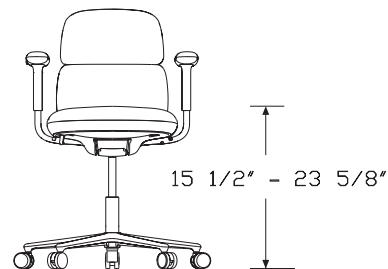

Extended height

# Asari Work Chair, Color Flood, Fully Assembled *continued*

Asari Work Chairs

Specification Information		
Step 1.		
<b>NU3</b>		
Step 2. Region Code		
<b>GN</b>	global standard compliant	+\$0
Step 3. Back Height		
<b>5</b>	mid back height	+\$1927
<b>6</b>	high back height	+\$1979
Step 4. Height Adjustment		
<b>1</b>	low-height range	+\$0
<b>2</b>	standard-height range	+\$0
<b>3</b>	extended-height range	+\$52
Step 5. Tilt		
<b>4</b>	self-adjusting synchronous tilt	+\$0
Step 6. Arms		
<b>N</b>	no arms	+\$0
<b>P</b>	fixed arms	+\$123
<b>H</b>	height-adjustable arms	+\$205
Step 7. Armpad Upholstery		
<i>For no arms (N)</i>		
<b>N</b>	no arms	+\$0
<i>For fixed arms (P) or height-adjustable arms (H)</i>		
<b>W</b>	nonupholstered armpads	+\$0
<b>F</b>	leather armpads	+\$154
Step 8. Seat-Depth Adjustment		
<b>F</b>	fixed seat depth	+\$0
Step 9. Base/Frame Color		
<i>For nonupholstered armpads (W)</i>		
<b>ZM</b>	alpine	+\$0
<b>CC1</b>	cocoa	+\$0
<b>PBL</b>	peacock	+\$0
<b>RLD</b>	marigold	+\$0
<b>DR1</b>	canyon	+\$0
<b>G1</b>	graphite (CP)	+\$0

<i>For leather armpads (F)</i>		
<b>DN2</b>	nightfall	+\$0
<b>BK</b>	black	+\$0

<i>For no arms (N)</i>		
<b>ZM</b>	alpine	+\$0
<b>CC1</b>	cocoa	+\$0
<b>PBL</b>	peacock	+\$0
<b>RLD</b>	marigold	+\$0
<b>DR1</b>	canyon	+\$0
<b>G1</b>	graphite (CP)	+\$0
<b>DN2</b>	nightfall	+\$0
<b>BK</b>	black	+\$0

## Step 10. Fabric

<i>For alpine (ZM)</i>		
Price Category 3		+\$64

<i>For cocoa (CC1)</i>		
Price Category 3		+\$64

<i>For graphite (CP) (G1)</i>		
Price Category 3		+\$64

<i>For peacock (PBL)</i>		
Price Category 8		+\$415

<i>For marigold (RLD)</i>		
Price Category 8		+\$415

<i>For canyon (DR1)</i>		
Price Category 8		+\$415

<i>For nightfall (DN2)</i>		
Price Category R		+\$1062

<i>For black (BK)</i>		
Price Category R		+\$1062

Step 11. Casters/Glides		
<b>BB</b>	2½" hard caster, black yoke, carpet	+\$0
<b>C7</b>	2½" caster, black yoke, hard floors	+\$50





**Product Information**

**Description**

These arms can be retrofitted to an Asari chair by Herman Miller™. Kit is available with fixed arms or height-adjustable arms. Fixed arm height is 9.53" from a compressed seat cushion to top of arm rest. Height-adjustable arm moves 3.93" vertically, from 7.68" to 11.61" above the seat. Arm components are preassembled.

**Dimensions**

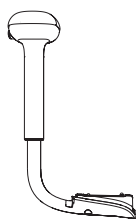

Adjustable arm

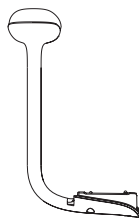
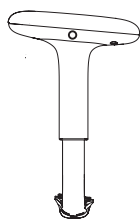

Fixed arm

**Specification Information**

**Step 1.**

**NU900**

**Step 2. Arms**

<b>P</b>	fixed arms	+\$123
<b>H</b>	height-adjustable arms	+\$205

**Step 3. Armpad Upholstery**

<b>W</b>	nonupholstered armpads	+\$0
<b>F</b>	leather armpads	+\$154

**Step 4. Frame Finish**

*For nonupholstered armpads (W)*

<b>CC1</b>	cocoa	+\$0
<b>DR1</b>	canyon	+\$0
<b>G1</b>	graphite (CP)	+\$0
<b>PBL</b>	peacock	+\$0
<b>RLD</b>	marigold	+\$0
<b>ZM</b>	alpine	+\$0

*For leather armpads (F)*

<b>BK</b>	black	+\$0
<b>DN2</b>	nightfall	+\$0
<b>G1</b>	graphite (CP)	+\$0
<b>ZM</b>	alpine	+\$0

**Step 5. Armpad Leather**

*For leather armpads (F) with black (BK)*

Price Category R	+\$70
------------------	-------

*For leather armpads (F) with nightfall (DN2)*

Price Category R	+\$70
------------------	-------

*For leather armpads (F) with graphite (CP) (G1), or alpine (ZM)*

Price Category R	+\$70
------------------	-------





# 20-Day or Less/Assigned Lead-Time Order Information

GSA

## **20-Day or Less and Assigned Lead-Time Programs**

20-day or less and assigned lead-time products are designed for established Herman Miller dealers with pre-approved credit.

Products are distributed from multiple manufacturing facilities across the United States. All products and options not designated by an Assigned Lead-Time icon  will ship in 20 business days or less after being acknowledged by Herman Miller. Products and options designated by an  are on the assigned lead-time program and will ship in 20 days, less than 20 days, or more than 20 days from order acknowledgement.

## **Ordering Procedure**

Please place orders through Order Manager. If this is not available to you, place orders through mail or fax. Verbal purchase orders will not be accepted.

Order Entry fax number for Meridian® Filing and Storage:

(616) 846 9236.

Order Entry fax number for all other products:

(616) 654 3085.

For more information, contact your Customer Care representative at:

(866) 854 3048 ext 3400.

## **Shipments and Delivery**

Per Herman Miller Terms and Conditions.

## **Changes and Cancellation**

Per Herman Miller Terms and Conditions.



# Casters and Glides

## GSA

⚠	<b>WARNING</b>	⚠
Depending on the floor surface, chair may unexpectedly roll away from user when entering or exiting the chair, possibly leading to unexpected injury. Please refer to descriptions of floor types when selecting casters.		

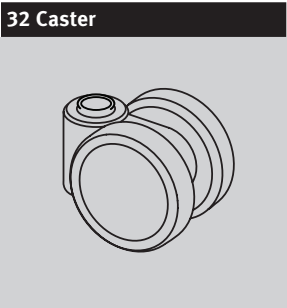

**32 Caster**

1 7/8-inch-diameter hard double-wheel caster; black nylon wheels and yoke; for use on carpet only

Applicable on:  
Sayl® Chairs

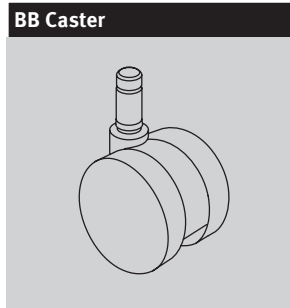

**BB Caster**

2 1/2-inch-diameter hard double-wheel caster; black nylon wheels and yoke; for use on carpet only

Applicable on:  
Asari Chair by Herman Miller™  
New Aeron® Chairs  
Caper® Chairs  
Embody® Chairs  
Fuld Nesting Chairs  
Lino™ Chairs  
Mirra® 2 Chairs  
Sayl Chairs      Verus™ Chairs



**BSC Caster**

2-inch-diameter double-wheel caster; black nylon wheels and hood; soft polyurethane tread; for use on hard floors or carpet

Applicable on:  
Eames® Aluminum Group

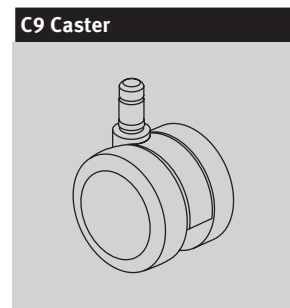

**C9 Caster**

2 1/2-inch-diameter double-wheel caster; black nylon wheels and yoke; soft polyurethane tread; internal brake; for use on hard floors or carpet

Applicable on:  
Caper Chairs  
Embody Chairs  
Lino Chairs  
Mirra 2 Chairs  
Sayl Chairs  
Setu Chairs      Verus Chairs

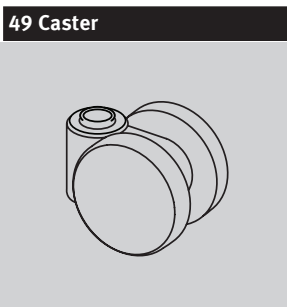

**49 Caster**

1 7/8-inch-diameter soft double-wheel caster; black nylon wheels and yoke; for use on hard floors or carpet

Applicable on:  
Sayl Chairs



**BKS Caster**

2 1/2-inch-diameter hard double-wheel caster; black yoke; quiet roll technology; for use on carpet only

Applicable on:  
Cosm™ Chairs

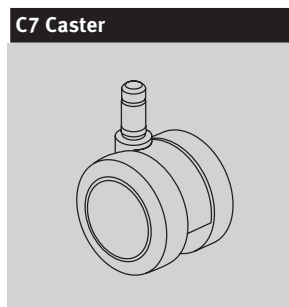

**C7 Caster**

2 1/2-inch-diameter double-wheel caster; black nylon wheels and yoke; soft polyurethane tread; for use on hard floors or carpet

Applicable on:  
Asari Chair by Herman Miller™  
New Aeron Chairs  
Caper Chairs  
Embody Chairs  
Fuld Nesting Chairs  
Lino Chairs      Sayl Chairs  
Mirra 2 Chairs      Verus Chairs



**CSQ Caster**

2 1/2-inch-diameter double-wheel caster; color-matched nylon wheels and yoke; soft polyurethane tread; for use on hard floors or carpet

Applicable on:  
Zeph® Chairs

# Casters and Glides

continued

## GSA

**DC1 Caster**

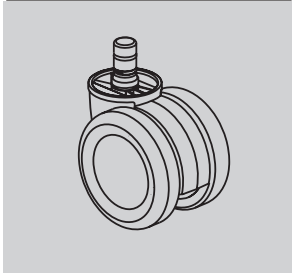

2<sup>1</sup>/<sub>2</sub>-inch-diameter double-wheel braking caster; black nylon wheels and yoke; for use on hard floors or carpet; quiet roll technology

Applicable on:  
New Aeron Chairs

**H9 Caster**

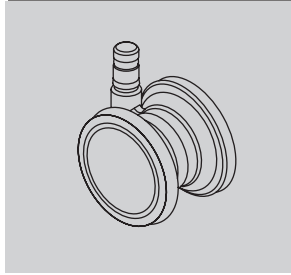

2<sup>1</sup>/<sub>2</sub>-inch-diameter double-wheel caster; clear polycarbonate wheels; nylon yoke; soft polyurethane tread; for use on carpet only.

Applicable on:  
Embody Chairs

**MD Caster**

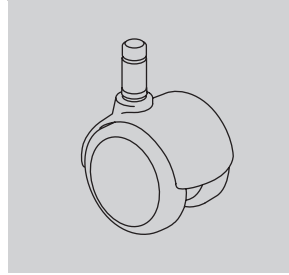

2-inch-diameter double-wheel caster; black nylon wheels with integral chrome hood; soft polyurethane tread; for use on hard floors or carpet

Applicable on:  
Eames® Aluminum Group

**SC8 Caster**

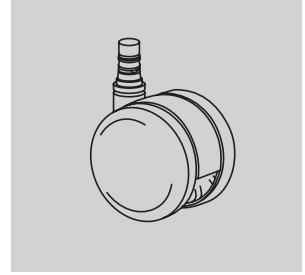

2<sup>1</sup>/<sub>2</sub>-inch-diameter double-wheel caster; black nylon wheels and yoke; soft polyurethane tread; quiet roll technology; for use on hard floors or carpet

Applicable on:  
Cosm Chairs  
Fuld Nesting Chairs  
Lino Chairs  
Mirra 2 Chairs  
Verus Chairs

**DS Caster**

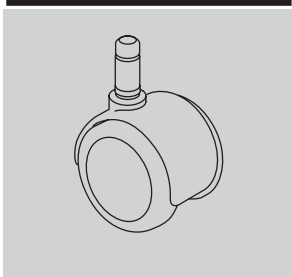

2-inch-diameter soft double-wheel braking caster; black nylon wheels and hood; for use on hard floors only

Applicable on:  
Aside® Chairs  
Caper Chairs

**HCC Caster**

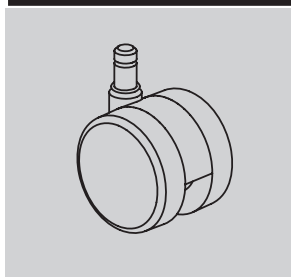

2<sup>1</sup>/<sub>2</sub>-inch-diameter double-wheel low roll resistance caster; black yoke; for use on hard floors or carpet.

Applicable on:  
Setu Chairs

**OC Caster**

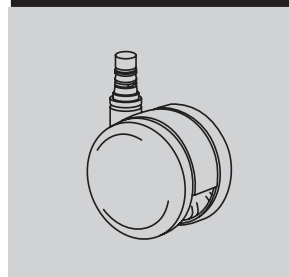

2<sup>1</sup>/<sub>2</sub>-inch-diameter double-wheel medium roll-resistant caster; black nylon wheels and yoke; soft polyurethane tread; for use on hard floors or carpet; quiet roll technology

Applicable on:  
Cosm Chairs  
Fuld Nesting Chairs  
Setu Chairs

**U4 Caster**

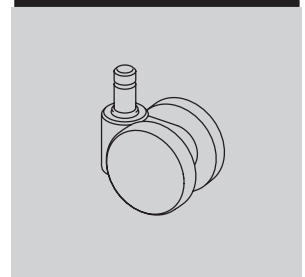

1<sup>7</sup>/<sub>8</sub>-inch-diameter hard double-wheel caster; black nylon wheels and yoke; for use on carpet only

Applicable on:  
Aside Chairs  
Verus Chairs

# Casters and Glides

continued

## GSA

**U5 Caster**

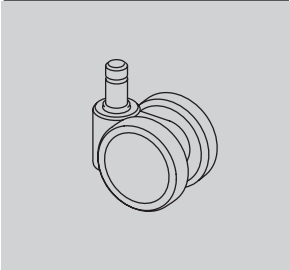

1<sup>7</sup>/<sub>8</sub>-inch-diameter soft double-wheel caster; black nylon wheels and yoke; for use on hard floors or carpet

Applicable on:

Aside Chairs  
Caper Chairs  
Verus Chairs

**VD Caster**

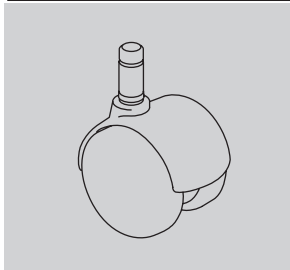

2-inch-diameter hard double-wheel caster; black nylon wheels with integral chrome hood; for use on carpet only

Applicable on:

Eames Aluminum Group

**69 Glide**

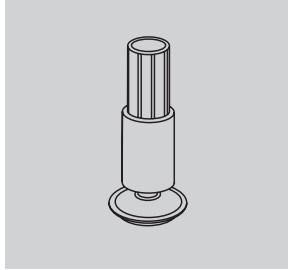

(Front glide shown)

2<sup>1</sup>/<sub>8</sub>-inch-high glide; black glass-filled nylon stem; steel-plated swivel foot with Floor Saver Glide® insert; for use on hard floors only

Applicable on:

Sayl Chairs

**GD Glide**

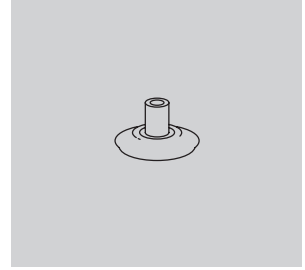

1<sup>1</sup>/<sub>2</sub>-inch-diameter glide; 1/2 inch in height; black nylon; for use on hard floors or carpet

Applicable on:

Eames Aluminum Group

**UD Caster**

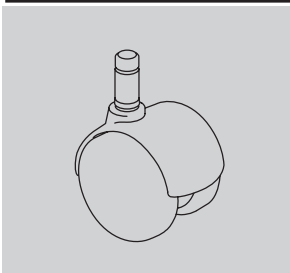

2-inch-diameter hard double-wheel caster; black nylon wheels with painted hood; for use on carpet only

Applicable on:

Eames® Aluminum Group

**16 Glide**

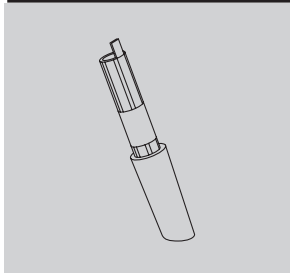

(Front glide shown)

2<sup>1</sup>/<sub>8</sub>-inch-high glide; black or fog acetal; for use on carpet only

Applicable on:

Sayl Chairs

**G4 Glide**

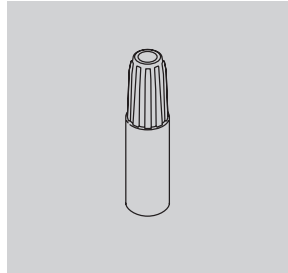

1<sup>7</sup>/<sub>8</sub>-inch-high glide; black acetal; for use on carpet only

Applicable on:

Verus Chairs

**GF Glide**

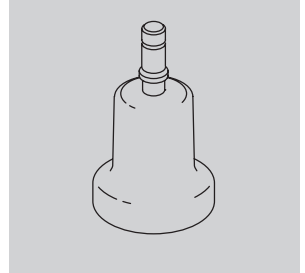

2<sup>1</sup>/<sub>2</sub>-inch-high glide; black nylon; for use on hard floors or carpet

Applicable on:

New Aeron Chairs  
Caper Chairs  
Cosm Chairs  
Lino Chairs  
Mirra 2 Chairs  
Sayl Chairs  
Verus Chairs

# Casters and Glides

continued

## GSA

### GFG Glide

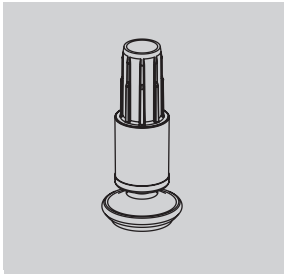

Floor Saver Glide™ insert; for use on hard floors only

Applicable on:

Zeph Chairs

### GLN Glide

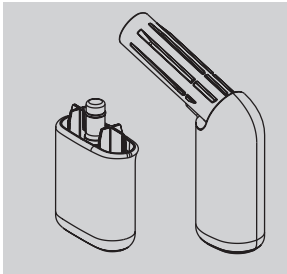

Acetal glide; for use on carpet only

Applicable on:

Fuld Nesting Chairs

### HG Glide

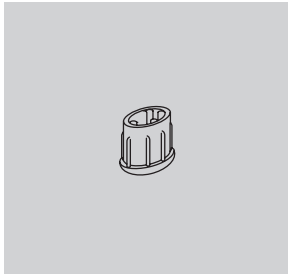

1/2-inch-high glide; black nylon glide with stainless-steel insert; for use on hard floors or carpet

Applicable on:

Aside Chairs

### X8 Glide

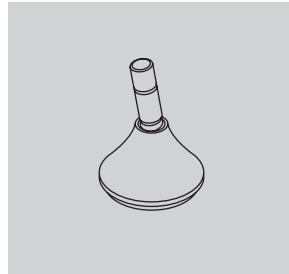

Glide; low profile; for use on hard floors or carpet

Applicable on:

Setu Chairs

### GL Glide

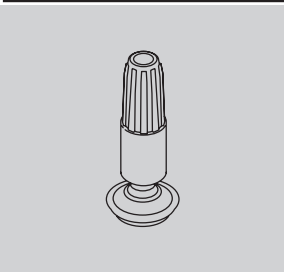

1 7/8-inch-high glide; black nylon stem; steel-plated swivel foot with Floor Saver Glide® insert; for use on hard floors only

Applicable on:

Verus Chairs

### GNB Glide

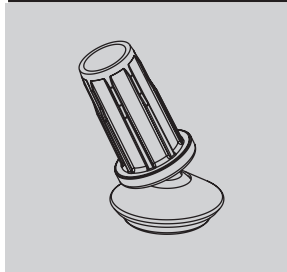

Swivel glide; nylon base; for use on carpet only

Applicable on:

Zeph Chairs

### SG Glide (for Aside)

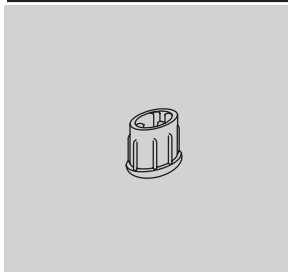

1/2-inch-high glide; black nylon; for use on carpet only

Applicable on:

Aside Chairs

### XS Glide

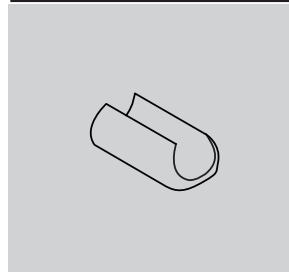

1/8-inch-high glide; polycarbonate in black, fog, clear, and studio white finishes; for use on hard floors or carpet

Applicable on:

Sayl Chairs



# Casters and Glides

continued

## GSA

### Y7 Glide

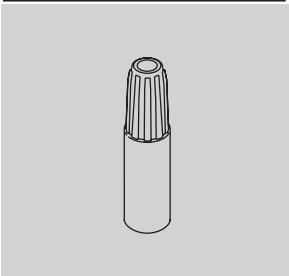

1<sup>7</sup>/<sub>8</sub>-inch-high glide; black acetal; for use on carpet only

Applicable on:

Caper Chairs

### YX Glide

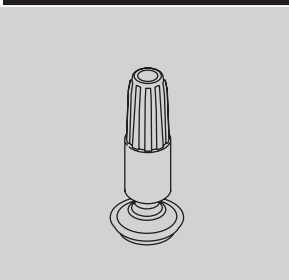

1<sup>7</sup>/<sub>8</sub>-inch-high glide; black nylon stem; steel-plated swivel foot with Floor Saver Glide® insert; for use on hard floors only

Applicable on:

Caper Chairs



# Textiles Application Chart — Seating GSA

• Available

[A] Assigned lead-time textile.

[A] Maharam textiles are on assigned lead times.

See following page for exception notes.

[N] Non-woven textile.

	Aeron® Chairs	Cosm™ Chairs	Mirra® 2 Chairs/Stools	Embody® Chairs	Fuld Nesting Chairs	Sayl® Work Chairs/Stools	Sayl Side Chairs	Setu® Chairs/Stools	Zeph® Chairs	Verus™ Work Chairs/Stools Back	Verus Work Chairs/Stools Seat	Verus Side Chairs Back	Verus Side Chairs Seat	Verus Plus Chairs	Aside® Chairs	Caper® Chairs/Stools	Lino™ Chairs Back	Lino Chairs Seat	OE1 Storage Trolley Cushion Top	Plex™ Lounge Furniture	Swoop™ Lounge Seating - Fully Upholstered	Swoop Lounge Seating - Plywood	Valor™ Seating	Cushion Tops	Workspaces	
<b>Price Category 1</b>																										
COM Customer's Own Material [A]						1	1			1	1	1	1	1	1			1	1	1	1	1	1	1	1	
231__ 8Z Pellicle®	•																									
1A7__ AireWeave 2			•																							
8T__ Crossing								•							•				•		•			•	•	
3DE__ Dex						•	•	•		•	•	•	•	•	•				•	19	•		•	•	•	
4RM__ Duo																	•									
6V__ Flexnet™																•										
845__ Intercept			•																							
4W__ Lyris 2™								•																		
1MN__ Monologue						25	23	•		•	•	•						•	•	•	•	•	•	•	•	
5H2__ Ripple 3D Knit									•																	
4SC__ Scatter						•	•	•		•	•	•	•	•	•			•	•	•	•	•		•	•	
5H1__ Splash 3D Knit									•																	
3DK__ Stretch Knit						22																				
235__ Tailored						•	•	•		•	•	•	•	•	•			•	24			•	7	•	•	
9NK__ Tuck 3D Knit					•																					
1WS__ Whisper						25	•	•		•	•	•	•	•	•			•	•	•	•	•	•	•	•	
<b>Price Category 2</b>																										
3AR__ Aristo						•	•	•		•	•	•	•	•	•			•	•	•	•	•	•	9	•	•
92__ Crepe						•	•	•		•	•	•	•	•	•			•	•	•	•	•	•	•	•	•
3EP__ Epic						•	•			•	•	•	•	•	•					•	•	•	•	7	•	•
3DP__ Hint						•	•			•	•	•	•	•	•			•					•	•	•	•
1MV__ Marvel [N]						22	23	•											•							
1HA__ Medley			•			•	23			•	•	•	•	•	•			•	•	•	•	•	•	•	•	•
4ME__ Mellow						•	23	•		•	•	•	•	•	•			•	•	•	•	•	•	•	•	•
ZMA__ Metaphor - Maharam [A]						16	16	•		•	•	•	•	•	•			•		•	•	•	•		•	•
8I1__ Muse - Maharam [A]						16	16			•	•	•	•	•	•			•						26	•	•
30__ Rhythm						24	•	•		•	•	•	•	•	•			•	•		•	•	•	•	•	•
3SL__ Sequel [N]						27	27	27		27	27	27	27	27	8			27	•	•	•	•	•	•	•	•
4TE__ Terra						•	23			•	•	•	•	•	•			•			•	•	•	7	•	•
8R__ Twist						•	•	•		•	•	•	•	•	•			•	•	•	•	•	•	•	•	•
<b>Price Category 3</b>																										
3AC__ Ace						22	•			•	•	•	•	•	8			•	•	19			•	•	•	
43Z__ Fractal						•	•	•		•	•	•	•	•	•			•		•	•	•	•	•	•	•
8M__ Latitude™							24																			
ZM2__ Meld - Maharam [A] *						•	•	•		•	•	•	•	•	•			•	•	•	•	•		•	•	
4GE__ Parcel						•	•	•		•	•	•	•	•	•			•		•	•	•	•	•	•	•
<b>Price Category 4</b>																										
3DM__ Daydream						22	•	•		•	•	•	•	•	•			•	•	•	•	•	•	•	•	•
ZLR__ Lariat						•	•	•		•	•	•	•	•	•			•						•	•	•
3SY__ Sync			•			•	•	•		•	•	•	•	•	•			•		•	•	•	•	•	•	•

Continued on next page

\* Available in select colors on 20-day lead-time. Refer to "Textile Colors" for 20-day colors.

# Textiles Application Chart — Seating

## GSA continued

• Available

[A] Assigned lead-time textile.

[A] Maharam textiles are on assigned lead times.

See following page for exception notes.

[N] Non-woven textile.

	Aeron® Chairs	Cosm™ Chairs	Mirra® 2 Chairs/Stools	Embody® Chairs	Fuld Nesting Chairs	Sayl® Work Chairs/Stools	Sayl Side Chairs	Setu® Chairs/Stools	Zeph® Chairs	Verus™ Work Chairs/Stools Back	Verus Work Chairs/Stools Seat	Verus Side Chairs Back	Verus Side Chairs Seat	Verus Plus Chairs	Aside® Chairs	Caper® Chairs/Stools	Lino™ Chairs Back	Lino Chairs Seat	OE1 Storage Trolley Cushion Top	Plex™ Lounge Furniture	Swoop™ Lounge Seating - Fully Upholstered	Swoop Lounge Seating - Plywood	Valo™ Seating	Cushion Tops	Workspaces
<b>Price Category 5</b>																									
5YT__ Arlo - Maharam																					20				
3CY__ Cozy						•	•	•		•	•	•	•	•	•			•		•	•	•	•	•	•
14A__ Hopsak						•	•	•		•	•	•	•	•	•			•	•	•	•	•	•	•	•
40G__ Method - Maharam [A]						16	16	•		•	•	•	•	•				•	•	•	•	•	•	•	•
ZNC__ Nico - Maharam [A]						•	•			•	•	•	•	•	•			•		•	•	•	•	•	•
3SU__ Summit						•	•	•		•	•	•	•	•				•		•	•	•	•	•	•
<b>Price Category 6</b>																									
35__ Balance				•																					
<b>Price Category 7</b>																									
COL Customer's Own Leather [A]	1														8				1						1
ZB3__ Beck - Maharam [A]						16	16	•		•	•	•	•	•				•		•	•	•	•	•	•
8PV__ Mantle - Maharam						16	16			•	•	•	•	•	•			•		•	•	•	•	•	•
5K3__ Rowan - Maharam						16	16			•	•	•	•	•	•			•		•	•	•	•	•	•
<b>Price Category 8</b>																									
ZLU__ Luce - Maharam [A]						16	16	•		•	•	•	•					•		•	•	•	•	•	•
<b>Price Category 9</b>																									
ZGE__ Gemma - Maharam [A]						•	•	•		•	•	•	•	•	•			•		•	•	•	•	•	•
ZJA__ Jasper - Maharam [A]						16	16			•	•	•	•	•	•			•		•	•	•	•	•	•
21__ Leather [N]	24														8			•	•			•	•	•	•
<b>Price Category 10</b>																									
3KH__ Firma - Maharam [A]						16		•		•	•	•	•	•	•			•		•	•	•	•	•	•
ZGF__ Gemma Multi - Maharam [A]						•	•	•		•	•	•	•	•	•			•		•	•	•	•	•	•
ZGF__ Gemma Multi Reverse - Maharam [A]						•	•	•		•	•	•	•	•	•			•		•	•	•	•	•	•
ZP4__ Petra - Maharam [A]						16	16			•	•	•	•	•	•			•		•	•	•	•	•	•
<b>Price Category 11</b>																									
3BS__ Felix - Maharam						16	16			•	•	•	•	•	•			•		•	•	•	•	•	•
<b>Price Category A</b>																									
No fabrics available at this time.																									
<b>Price Category B</b>																									
VM__ Medium - Maharam						•	•			•	•	•	•	•	•			•	•				•	•	•
TL__ Messenger - Maharam [A] *						•	•	•		•	•	•	•	•	•			•	•	•	•	•	•	•	•
<b>Price Category C</b>																									
Z27__ Manner - Maharam [A]						•	•			•	•	•	•	•	•			•	•	•	•	•	•	•	•
887__ Merit - Maharam [A]						•	•			•	•	•	•	•	•			•	•	•	•	•	•	•	•
Z3__ Metric - Maharam [A]						•	•			•	•	•	•	•	•			•	•	•	•	•	•	•	•
8EY__ Murmur - Maharam [A]						•	16			•	•	•	•	•	•			•		•	•	•	•	•	•
<b>Price Category D</b>																									
818__ Bluff - Maharam [N] [A]						16	16			•	•	•	•	•	8				21		•	•	•	•	•
ZMD__ Mode - Maharam [A]						18	•	•		•	•	•	•	•	•			•	•	•	•	•	•	•	•
<b>Price Category E</b>																									
ZAT__ Article - Maharam [N] [A]						16	16			•	•	•	•					•					•	•	•

Continued on next page

\* Available in select colors on 20-day lead-time. Refer to "Textile Colors" for 20-day colors.

# Textiles Application Chart — Seating

## GSA continued

• Available

[A] Assigned lead-time textile.

[A] Maharam textiles are on assigned lead times.

See following page for exception notes.

[N] Non-woven textile.

	Aeron® Chairs	Cosm™ Chairs	Mirra® 2 Chairs/Stools	Embody® Chairs	Fuld Nesting Chairs	Sayl® Work Chairs/Stools	Sayl Side Chairs	Setu® Chairs/Stools	Zeph® Chairs	Verus™ Work Chairs/Stools Back	Verus Work Chairs/Stools Seat	Verus Side Chairs Back	Verus Side Chairs Seat	Verus Plus Chairs	Aside® Chairs	Caper® Chairs/Stools	Lino™ Chairs Back	Lino Chairs Seat	OE1 Storage Trolley Cushion Top	Plex™ Lounge Furniture	Swoop™ Lounge Seating - Fully Upholstered	Swoop Lounge Seating - Plywood	Valor™ Seating	Cushion Tops	Workspaces
<b>Price Category F</b>																									
82T__ Apt [N] - Maharam [A]						18	•					•	•								•			•	7
74M__ Instill [N] - Maharam [A]						18	16			•	•	•	•					•		•		•	•	•	7
89N__ Keen - Maharam [A]						16	16			•	•	•	•					•		•	•	•			
V9G__ Ledger - Maharam [A]						18	16			•	•	•	•					•	•				•	•	
ZLL__ Loop - Maharam [A]						16	16			•	•	•			8			•					•		
8LW__ Pepper - Maharam [A]						16	16			•	•	•			•			•		21	•			9	
Z33__ Strum - Maharam [N] [A]						16															•		•	7	
<b>Price Category G</b>																									
ZC2__ Compound - Maharam [N] [A]						16	16			•	•	•	•		8			•		•		•	•	•	7
8AR__ Gild - Maharam [A]						16				•	•	•	•							21	•	•	•		
<b>Price Category H</b>																									
ZT__ Circles - Maharam [A]						16	16																		•
ZK__ Dot Pattern - Maharam [A]						•	•	•		•	•	•			•				•				•	•	
ZL__ Small Dot Pattern - Maharam [A]						•	•	•		•	•	•			•				•				•	•	
<b>Price Category I</b>																									
7CW__ Cursive - Maharam [A]						16	16			•	•	•	•		8			•	•		•		•	•	
<b>Price Category J-V</b>																									
No fabrics available at this time.																									

Application Note: Herman Miller cannot guarantee material/pattern alignment in adjacent products. For example, a fabric's pattern may not align from one pedestal cushion top to the next, or from one chair to another.

- |  |  |
|--|--|
| 1 Refer to price book appendices and Omni for COM/COL information. | 22 Not available on Sayl upholstered back work chairs.                       |
| 7 Available on 1" Cushion Tops only.                               | 23 Not available on Sayl side chairs with upholstered backs.                 |
| 8 Only available on Aside non-upholstered outer back (PB) option.  | 24 Available in select colors. Refer to "Textile Colors" for color offering. |
| 9 Available on Valor upholstered seat only.                        | 25 Not available on Sayl upholstered High-Back Work Chairs.                  |
| 16 Available on Sayl Chair seat.                                   | 26 Available in select colors. Refer to "Textile Colors" for color offering. |
| 18 Available on Sayl Chair seat and upholstered mid-back.          | 27 Not available in 3SL15 Carbon Dark.                                       |
| 19 Available on Plex seat only.                                    |  |
| 20 Not available on Plex Club Chair with Headrest.                 |  |
| 21 Available on Plex seat and on ottoman.                          |  |



# Textile Colors

## GSA

### Price Category 1

**Customer's Own Material**  
Ancillary/Seating/Workspaces  
See Order Information in  
Appendices.  
Assigned lead-time textile. A

**8Z Pellicle®**  
Seating  
For New Aeron® Chairs  
56% elastomeric  
44% polyester  
23101 Mineral  
23102 Carbon  
23103 Graphite

**AireWeave™ 2**  
Seating  
For Mirra® 2 Chairs  
67% elastomeric  
33% antimony-free polyester  
1A701 Alpine  
1A702 Slate Grey  
1A703 Graphite  
1A704 Lime Green  
1A706 Urban Orange  
1A708 Twilight

**Chain**  
Workspaces  
66" wide  
100% recycled polyester  
with 12% ocean bound plastic  
2V01 Pearl  
2V02 Oyster  
2V03 Wheat  
2V04 Linen  
2V05 Wicker  
2V06 Bamboo  
2V07 Sage  
2V08 Spring Wood  
2V09 Iceberg

**Crossing**  
Seating/Workspaces  
54" wide  
86% antimony-free polyester  
14% polyester  
8T03 Wicker \*  
8T04 Porcelain \*  
8T05 Warm Grey \*  
8T10 Tomato  
8T17 Cerulean  
8T18 Indigo  
8T19 Shale \*  
8T22 Tin \*  
8T23 Graphite  
8T24 Black

**Crossing**  
Workspaces  
For systems products only.  
54" wide  
86% antimony-free polyester  
14% polyester  
8501 Ivory \*  
8502 Oyster \*

\* Crossing colors available  
on Exclave® Video-friendly  
Tackable Boards and Stowage  
Tackable Backdrop

**Dex**  
Seating/Workspaces  
54" wide  
67% recycled polyester  
33% polyester  
3DE01 Frost  
3DE02 Silver Pine  
3DE03 Stone  
3DE04 Shale  
3DE05 Charcoal  
3DE06 Gossamer  
3DE07 Pine

**Duo**  
Seating  
For Lino™ Chairs  
52% polyester  
48% elastomeric  
4RM01 Mineral  
4RM02 Poppy  
4RM03 Green Leaf  
4RM04 Jade  
4RM05 Shadow  
4RM06 Graphite

**Flexnet™**  
Seating  
For Caper® Chairs  
69% elastomeric  
31% polyester  
6V01 Black  
6V02 Silver Grey

**Grasscloth**  
Workspaces  
66" wide  
100% recycled polyester  
with 11% ocean bound plastic  
2I01 Silver Birch  
2I02 Pampas  
2I03 Sedge  
2I07 Lea  
2I08 Taro  
2I09 Steam Grey  
2I13 Gravel

**Intercept**  
Seating  
For Cosm™ Chairs  
60% elastomeric  
40% polyester  
84501 Graphite  
84502 Carbon  
84503 Mineral  
84504 Nightfall  
84505 Glacier  
84506 Canyon

**Lyris 2™**  
Seating  
For Setu® Chairs  
74% elastomeric  
26% polyester  
4W21 Alpine  
4W23 Chartreuse  
4W25 Berry Blue  
4W26 Slate Grey  
4W28 Chino  
4W31 Graphite

**Monologue**  
Ancillary/Seating/Workspaces  
54" wide  
56% recycled polyester  
44% polyester  
1MN01 Linen  
1MN02 Alabaster  
1MN04 Folkstone  
1MN05 Silver Pine  
1MN06 Slate  
1MN07 Seed  
1MN09 Persimmon  
1MN11 Meadow  
1MN12 Blue Sky  
1MN13 Blue Spruce  
1MN14 Deep Sea

Price category 1 continued on  
next page

# Textile Colors

continued

GSA

## Price Category 1

continued

Appendix: Textile Colors

Resonance	
Workspaces	
66" wide	
100% polyester	
5T04	Greige
5T05	Porcelain
5T06	Alabaster
5T15	Iris
5T28	Sugar
5T47	Tobacco
5T54	Saltbush
5T57	Seed
5T58	Sepia
5T60	Iceberg
5T65	Red
5T68	Pistachio
5T71	Jade
5T72	Blue Green
5T74	Twilight

Ripple 3D Knit	
Seating	
Available only on Zeph® Chairs.	
knit to size	
99% recycled polyester	
1% lycra	
5H201	Black
5H202	Carbon
5H203	Alpine
5H204	Silt
5H205	Tea Rose
5H206	Cocoa
5H207	Persimmon
5H208	Blaze
5H209	Cayenne
5H210	Falcon
5H211	Mustard Seed
5H212	Patina
5H213	Olive
5H214	Moss
5H215	Aloe
5H216	Glacier
5H217	Ultramarine
5H218	Nightfall
5H219	Bluebell
5H220	Boysenberry
5H221	Nightfall/Bluebell
5H222	Patina/Alpine
5H223	Cayenne/Glacier
5H224	Tea Rose/Olive
5H225	Silt/Blaze

Scatter	
Ancillary/Seating/Workspaces	
54" wide	
100% recycled polyester,	
with 26% ocean bound plastic	
4SC01	Alpine
4SC02	Fog
4SC03	Shale
4SC04	Persimmon
4SC07	Olive
4SC08	Glacier
4SC09	Blue Sky
4SC10	Lagoon
4SC11	Slate Grey
4SC12	Blue Black

Scribe	
Ancillary/Seating/Workspaces	
54" wide	
100% recycled polyester	
with 53% ocean bound plastic	
3DN01	Spring Wood
3DN02	Poplar
3DN03	Pewter
3DN04	Deep Sea
3DN05	Fir
3DN06	Nutmeg

Slant	
Workspaces	
66" wide	
51% polyester	
49% recycled polyester	
22F04	Pesto
22F06	Neptune
22F07	Blueberry
22F10	Pumpkin
22F12	Silver Birch
22F13	Bluestone
22F15	Shale

Splash 3D Knit	
Seating	
Available only on Zeph® Chairs.	
knit to size	
98% recycled polyester	
2% lycra	
5H101	Black
5H102	Carbon
5H103	Alpine
5H104	Silt
5H105	Tea Rose
5H106	Cocoa
5H107	Persimmon
5H108	Blaze
5H109	Cayenne
5H110	Falcon
5H111	Mustard Seed
5H112	Patina
5H113	Olive
5H114	Moss
5H115	Aloe
5H116	Glacier
5H117	Ultramarine
5H118	Nightfall
5H119	Bluebell
5H120	Boysenberry

Stretch Knit	
Seating	
Assigned lead-time textile. <span style="border: 1px solid black; padding: 0 2px;">A</span>	
Available only on Sayl®	
Suspension Back Work Chairs	
97% polyester, 3% spandex	
3DK01	Fog
3DK02	Slate Grey
3DK03	Java
3DK04	Black
3DK05	Red
3DK06	Green Apple
3DK07	Berry Blue

Price category 1 continued on next page



# Textile Colors

continued

## GSA

### Price Category 1

continued

Tailored	
Ancillary/Seating/Workspaces	
54" wide	
56% polyester	
44% recycled polyester	
23501	Studio White * **
23502	Sugar **
23503	Tomato
23506	Chive
23508	Cobalt
23509	Cadet
23510	Fog
23511	Graphite
23512	Black
23513	Coffee

\* Color not available on Canvas Tiles.  
 \*\* Colors not available on Plex™ Lounge Furniture.

Tuck 3D Knit	
Seating	
Available only on Fuld Nesting Chairs.	
knit to size	
56% polyester	
44% recycled polyester	
9NK01	Alpine
9NK02	Carbon
9NK03	Nightfall
9NK04	Olive
9NK05	Cocoa
9NK06	Canyon

Whisper	
Ancillary/Seating/Workspaces	
54" wide	
73% recycled polyester	
27% polyester,	
with 11.3% ocean bound plastic	
1WS01	Sand Dollar
1WS02	Pebble
1WS03	Silver Birch
1WS04	Iceberg
1WS05	Silver Pine
1WS06	Carbon
1WS07	Cumin
1WS12	Willow
1WS13	Sea Grass
1WS14	Pool
1WS15	Blueberry
1WS16	Glacier
1WS17	Grey
1WS18	Canyon

### Price Category 2

Aristo	
Seating/Workspaces	
54" wide	
88% recycled polyester	
12% polyester	
Acrylic backing	
3AR01	Forest Moss
3AR02	Light Brindle
3AR03	Mink
3AR04	Copper
3AR06	Cherry
3AR08	Green Apple
3AR10	Waterfall
3AR11	Cadet
3AR12	Tin
3AR13	Pewter
3AR14	Grey Brindle
3AR15	Grey Black

Cord	
Workspaces	
66" wide	
51% antimony-free polyester	
49% polyester	
5101	Ivory
5102	White Ash
5103	Linen
5104	Bamboo
5105	Sepia
5107	Sesame
5109	Bayou
5111	Spring Wood
5112	Summer White

Crepe	
Ancillary/Seating/Workspaces	
54" wide	
100% recycled polyester,	
with 43.6% ocean bound plastic	
9201	Licorice
9203	Smoke
9207	Cherry
9223	Cadet
9241	Beachglass
9249	Stone *
9251	Fog *
9252	Slate Grey
9261	Shale
9262	Graphite
9265	Mineral
9266	Persimmon
9267	Juniper
9268	Glacier
9269	Cascade
9270	Navy

\* Colors available on Exclave® Video-friendly Tackable Boards and Stowage Tackable Backdrop

Epic	
Seating/Workspaces	
54" wide	
56% recycled polyester	
44% polyester	
Acrylic backing	
3EP01	Alabaster
3EP02	Smoke
3EP03	Falcon
3EP05	Copper
3EP06	Urban Orange
3EP07	Poppy
3EP10	Clover
3EP11	Loden
3EP14	Peacock
3EP15	Cadet
3EP16	Indigo
3EP17	Spring Wood
3EP18	Grey Brindle
3EP19	Seed
3EP20	Carbon Dark

Price category 2 continued on next page

# Textile Colors

continued

GSA

## Price Category 2

continued

Appendix: Textile Colors

Hint	
Seating/Workspaces	
54" wide	
76% recycled polyester	
24% polyester	
3DP01	Sediment
3DP02	Gunmetal
3DP03	Silt
3DP04	Porcelain
3DP05	Indigo
3DP06	Fern
3DP07	Adobe
3DP08	Red Sea

Horizon	
Workspaces	
54" wide	
65% antimony-free polyester	
35% polyester	
4N01	Rye Grass
4N02	Sugar Pine
4N03	Silver Pine
4N04	White Ash
4N05	Spring Wood
4N08	Haystack
4N09	Oat Grass
4N13	Pine Cone
4N15	Elderberry

Marvel	
Seating	
54" wide	
100% pvc-free polyurethane	
1MV01	Summer White
1MV02	Sand Dollar
1MV03	Espresso
1MV04	Folkstone Grey
1MV05	Graphite
1MV06	Onyx
1MV07	Polar Blue
1MV08	Blush Grey
1MV12	Red
1MV14	Pine
1MV15	Teal Green
1MV16	Twilight

Medley	
Ancillary/Seating/Workspaces	
54" wide	
50% recycled polyester	
50% polyester	
1HA01	Stone *
1HA02	Trail
1HA03	Charcoal
1HA04	Cinder
1HA06	Papaya
1HA07	Chutney
1HA09	Feather Grey *
1HA11	Loden
1HA13	Bayou *
1HA14	Blue Grotto
1HA15	Blueberry
1HA22	Khaki
1HA23	Pewter
1HA24	Yellow Oxide
1HA25	Vintage Rose
1HA26	Raspberry
1HA27	Acai Berry

\* Colors available on Exclave®  
Video-friendly Tackable Boards  
and Stowage Tackable Backdrop

Mellow	
Seating/Workspaces	
54" wide	
100% recycled polyester, with 16% ocean bound plastic	
4ME01	Mineral
4ME04	Olive
4ME05	Glacier
4ME06	Oceanside
4ME07	Charcoal

Metaphor – Maharam	
Ancillary/Seating/Workspaces	
54" wide	
100% polyester	
Acrylic backing	
ZMA01/466553-001	Afterfeather
ZMA02/466553-002	Moonflower
ZMA03/466553-003	Handcraft
ZMA04/466553-004	Crossroad
ZMA05/466553-005	Chondrite
ZMA06/466553-006	Detective
ZMA07/466553-007	Steamship
ZMA08/466553-008	Electricity
ZMA09/466553-009	Takeoff
ZMA10/466553-010	Parachute
ZMA11/466553-011	Blueshift
ZMA12/466553-012	Dockyard
ZMA13/466553-013	Bathe
ZMA14/466553-014	Icebound
ZMA15/466553-015	Thermosphere
ZMA16/466553-016	Aboard
ZMA17/466553-017	Agateware
ZMA18/466553-018	Homeland
ZMA19/466553-019	Rockfall
ZMA20/466553-020	Undergrowth
ZMA21/466553-021	Gremolata
ZMA22/466553-022	Patina
ZMA23/466553-023	Sylvan
ZMA24/466553-024	Outfield
ZMA25/466553-025	Windbreak
ZMA26/466553-026	Saguaro
ZMA27/466553-027	Barnwood
ZMA28/466553-028	Cookshop
ZMA29/466553-029	Amandine
ZMA30/466553-030	Bodhran
ZMA31/466553-031	Centerstage
ZMA32/466553-032	Focaccia
ZMA33/466553-033	Bumblebee
ZMA34/466553-034	Microbrew
ZMA35/466553-035	Sauna
ZMA36/466553-036	Gazebo
ZMA37/466553-037	Pirouette
ZMA38/466553-038	Heartbeat
ZMA39/466553-039	Shino
ZMA40/466553-040	Sunrise

Metaphor continued	
ZMA41/466553-041	Florist
ZMA42/466553-042	Beadwork
ZMA43/466553-043	Framboise
ZMA44/466553-044	Wisteria
ZMA45/466553-045	Warrior

Muse – Maharam	
Ancillary/Seating/Workspaces	
54" wide	
100% post-consumer recycled polyester	
8I101/466487-001	Crescendo
8I102/466487-002	Resonate
8I103/466487-003	Runway
8I104/466487-004	Ascend
8I105/466487-005	Veil
8I106/466487-006	Refresh
8I107/466487-007	Clear
8I108/466487-008	Fantasy
8I109/466487-009	Miso
8I110/466487-010	Compass
8I111/466487-011	Bergamot
8I112/466487-012	Grasshopper
8I113/466487-013	Goal
8I114/466487-014	Mistletoe
8I115/466487-015	Seaglass
8I116/466487-016	Frigid
8I117/466487-017	Riverbend
8I118/466487-018	Noble
8I119/466487-019	Pulsar
8I120/466487-020	Velella
8I121/466487-021	Sailboat
8I122/466487-022	Sparse
8I123/466487-023	Vase
8I124/466487-024	Haven
8I125/466487-025	Mead
8I126/466487-026	Neat
8I127/466487-027	Jovial
8I128/466487-028	Theater
8I129/466487-029	Poinsettia
8I130/466487-030	Celebrate
8I131/466487-031	Spectacle

Price category 2 continued on next page

# Textile Colors

continued

## GSA

### Price Category 2

continued

#### Rhythm

Seating	
54" wide	
100% polyester	
3002	Green Apple
3004	Bayou
3005	Berry Blue
3006	Iris
3007	Twilight
3009	Poppy
3010	Molasses
3012	Khaki
3013	Mink
3014	Black *
3015	Charcoal *

\* Colors available on Embody® Chair

#### Sequel

Ancillary/Seating/Workspaces	
54" wide	
100% vinyl	
100% polyester knit backing	
Resilience® finish	
3SL01	White
3SL02	Pebble
3SL03	Mushroom
3SL04	Stone
3SL09	Seal
3SL10	Blue Fog
3SL11	Folkstone
3SL12	Shale
3SL13	Slate Grey
3SL14	Charcoal
3SL15	Carbon Dark
3SL28	Navy *

\* Color available on Eames® Tandem Sling Seating

#### Terra

Ancillary/Seating/Workspaces	
54" wide	
100% post-consumer recycled biodegradable polyester *	
4TE01	Spring Wood
4TE02	Zinc
4TE03	Pine Cone
4TE04	Charcoal
* 1% biodegradation in 1,278 days under ASTM D5511 conditions. No evidence of further degradation.	

#### Twine

Workspaces	
66" wide	
100% recycled polyester	
3TW01	Silver Birch
3TW02	Ivory
3TW03	Alabaster
3TW04	Bamboo
3TW05	Iceberg
3TW06	Charcoal
3TW07	Feather Grey
3TW08	Shale

#### Twist

Ancillary/Seating/Workspaces	
54" wide	
80% antimony-free polyester	
13% recycled polyester	
7% polyester	
8R05	Wicker
8R10	Poppy
8R14	Tin
8R15	Shale
8R16	Graphite
8R17	Birch
8R18	Sepia
8R22	Blueberry
8R23	Green Apple
8R26	Gunmetal
8R27	Cinder
8R29	Pekoe
8R33	Forest
8R35	Waterfall
8R36	Midnight Blue
8R37	Carbon Dark

#### Twist

Workspaces	
For systems products only.	
54" wide	
80% antimony-free polyester	
13% recycled polyester	
7% polyester	
5S03	Oyster

### Price Category 3

#### Ace

Ancillary/Seating	
54" wide	
100% polyurethane	
Polyester knit backing	
Stain resistant finish	
3AC01	Summer White
3AC02	White Ash
3AC04	Metal
3AC05	Clay
3AC06	Chestnut
3AC08	Camelback
3AC09	Chipotle
3AC12	Artichoke
3AC13	Sepia Dark
3AC14	Aloe
3AC17	Oceanside
3AC18	Midnight
3AC20	Frost
3AC21	Lead
3AC22	Black

#### Fractal

Ancillary/Seating/Workspaces	
58" wide	
84% recycled polyester	
16% polyester	
43Z01	Granite
43Z02	Golden Olive
43Z03	Verdant
43Z04	Cadet

Price category 3 continued on next page

# Textile Colors

continued

## GSA

### Price Category 3

continued

Appendix: Textile Colors

Ground Cloth®	
Workspaces	
66" wide	
100% polyester	
4701	Vapor Grey
4721	Warm White *
4722	Fog *
4723	Straw *
4724	Red Orange *
4726	Green Apple *
4727	Caribbean *
4728	Midnight *
4729	Cappuccino *

\* Colors available on Exclave®  
Video-friendly Tackable Boards  
and Stowage Tackable Backdrop

Latitude	
Seating	
Colors for Mirra 2 Chairs	
100% polyester	
8M10	Alpine
8M17	Black
8M23	French Press
8M27	Cordovan
8M28	Ochre
8M29	Ultramarine
8M30	Olive

Meld - Maharam	
Seating/Workspaces	
Workspaces	
54" wide	
68% post-consumer recycled polyester	
32% polyester	
PFOA-Free stain resistant	
ZM201/466387-201	Vast
ZM202/466387-202	Panda **
ZM203/466387-203	Skyline *
ZM204/466387-204	Knight **
ZM205/466387-205	Quill **
ZM206/466387-206	Pipe
ZM207/466387-207	Grate *
ZM208/466387-208	Gloss
ZM209/466387-209	Bulb

Meld continued	
ZM210/466387-210	Bride
ZM211/466387-211	Stark
ZM212/466387-212	Seashell
ZM213/466387-213	Antler
ZM214/466387-214	Crater *
ZM215/466387-215	Perennial
ZM216/466387-216	Mulberry
ZM217/466387-217	Fuchsia *
ZM218/466387-218	Amethyst *
ZM219/466387-219	Merlot
ZM220/466387-220	Magma *
ZM221/466387-221	Rooster
ZM222/466387-222	Heat *
ZM223/466387-223	Clementine
ZM224/466387-224	Fox
ZM225/466387-225	Kiss *
ZM226/466387-226	Bare
ZM227/466387-227	Blonde
ZM228/466387-228	Mimosa
ZM229/466387-229	Comet *
ZM230/466387-230	Honeydew
ZM231/466387-231	Wild *
ZM232/466387-232	Vine
ZM233/466387-233	Seed
ZM234/466387-234	Kale *
ZM235/466387-235	Waterfall *
ZM236/466387-236	Nordic *
ZM237/466387-237	Reef *
ZM238/466387-238	Wave
ZM239/466387-239	Isle **
ZM240/466387-240	Creek
ZM241/466387-241	Mariner *
ZM242/466387-242	Globe
ZM243/466387-243	Spa

\* Colors available on  
20-day lead time.  
\*\* Colors available on  
10-day lead time.

Parcel	
Ancillary/Seating/Workspaces	
54" wide	
100% recycled polyester	
4GE01	Gunmetal
4GE02	Brindle
4GE03	Bayou
4GE04	Pesto
4GE05	Golden Olive
4GE06	Copper Sea

Saille - Geiger Textile	
Ancillary	
57" wide	
69% cotton	
31% polyester	
PFOA-Free stain resistant finish	
Acrylic backing	
18001	Coal
18002	Shale
18003	Haze
18004	Stone
18005	White *
18006	Beach
18007	Sand
18008	Blush
18009	Brick
18010	Fog
18011	Celadon
18012	Poolside
18013	Summer Sky
18014	Lake
18015	Midnight Blue

\* Color not available on Eames®  
Soft Pad Group Chairs/Ottomans.

Strands	
Workspaces	
66" wide	
100% recycled polyester	
8W01	Pebble
8W02	Porcelain
8W04	Honey
8W05	Khaki
8W06	Rye
8W07	Wicker
8W08	Tin
8W09	Cool Grey

# Textile Colors

continued

## GSA

### Price Category 4

Cygnus	
Ancillary	
For Eames® Aluminum Group Chairs	
69% elastomeric	
31% polyester	
5401	Black
5402	Zinc
5403	Quartz

Daydream	
Ancillary/Seating	
54" wide	
48% wool	
41% recycled polyester	
9% nylon	
2% polyester	
3DM01	Rye Grass
3DM02	Silver Birch
3DM03	Pewter
3DM04	Graphite
3DM05	Black
3DM06	Lemongrass
3DM07	Permission
3DM08	Juniper
3DM09	Sea Grass
3DM10	Nightfall

Kalista - Geiger Textile	
Ancillary	
54" wide	
71% post-industrial recycled cotton	
18% post-industrial recycled polyester	
11% polyester	
PFOA-Free stain resistant finish	
1AL01	Cotton
1AL02	Natural
1AL03	Titanium
1AL04	Pewter
1AL05	Starry Night
1AL06	Red Hot
1AL07	Sun Kissed
1AL08	Dune
1AL09	Beach Glass
1AL10	Bluestone
1AL11	Seaside
1AL12	Night Sky

Lariat – Maharam	
Ancillary/Seating	
54" wide	
100% vinyl	
ZLR01/440401-001	001
ZLR02/440401-002	002
ZLR04/440401-004	004
ZLR06/440401-006	006
ZLR07/440401-007	007
ZLR08/440401-008	008
ZLR10/440401-010	010
ZLR11/440401-011	011
ZLR13/440401-013	013
ZLR14/440401-014	014
ZLR15/440401-015	015
ZLR16/440401-016	016
ZLR18/440401-018	018
ZLR20/440401-020	020
ZLR21/440401-021	021
ZLR24/440401-024	024
ZLR25/440401-025	025
ZLR26/440401-026	026
ZLR28/440401-028	028
ZLR31/440401-031	031
ZLR32/440401-032	032
ZLR33/440401-033	033
ZLR34/440401-034	034
ZLR38/440401-038	038
ZLR39/440401-039	Granite
ZLR40/440401-040	Linen
ZLR41/440401-041	Stella
ZLR42/440401-042	Saddle
ZLR43/440401-043	Holly
ZLR44/440401-044	Maroon
ZLR45/440401-045	Siren
ZLR46/440401-046	Reseda
ZLR47/440401-047	Purslane
ZLR48/440401-048	Spire
ZLR49/440401-049	Papyrus
ZLR50/440401-050	Chickadee
ZLR51/440401-051	Requiem

Sync	
Ancillary/Seating	
55" wide	
100% polyester	
3SY01	Pine Cone
3SY03	Canyon
3SY04	Truffle
3SY06	Everglade
3SY08	Nightfall
3SY09	Dark Mineral
3SY10	Slate Grey
3SY11	Dark Carbon
3SY12	Black

### Price Category 5

Arlo - Maharam	
Ancillary/Seating	
70% wool	
30% polyester	
5YT01	Turn
5YT02	Embers
5YT03	Parallel
5YT04	Octave
5YT05	Musing
5YT06	Summon
5YT07	Dynamic
5YT08	Signals
5YT09	Aspect
5YT10	Dedicate
5YT11	Juniper
5YT12	Cilantro
5YT13	Hawthorn
5YT14	Thread
5YT15	Spalted
5YT16	Warmer
5YT17	Misted
5YT18	Share
5YT19	Chord
5YT20	Heroic
5YT21	Arpeggio
5YT22	Roots
5YT23	Sumac
5YT24	Purl
5YT25	Homeward

Cozy	
Ancillary/Seating	
54" wide	
100% wool	
3CY01	Heathered Warm Grey
3CY02	Heathered Rye Grass
3CY03	Heathered Cool Grey
3CY05	Heathered Black
3CY06	Heathered Persimmon
3CY07	Heathered Loden
3CY09	Heathered Lagoon
3CY10	Heathered Twilight

Price category 5 continued on next page

# Textile Colors

continued

## GSA

### Price Category 5

continued

#### Hopsak

Ancillary/Seating/Workspaces

56" wide

100% recycled polyester

14A20	Black
14A22	Raw Umber Dark
14A26	Grey Blue Dark
14A30	Sepia Dark
14A38	Emerald Dark
14A39	Yellow Dark
14A40	Orange
14A41	Sienna
14A42	Olive Green Dark
14A43	Crimson
14A44	Crimson Dark Dark
14A45	Violet Dark
14A46	Pink Dark Dark
14A47	Ultramarine Dark
14A48	Cobalt Blue
14A49	Terra Cotta
14A50	Ochre Dark

#### Ingenue - Geiger Textile

Ancillary

54" wide

28% wool

26% viscose

25% acrylic

16% polyester

5% cotton

PFOA-Free stain resistant finish

1GH01	Sand
1GH02	Fog
1GH03	Flannel
1GH04	Trench
1GH05	Vermillion
1GH06	Adriatic
1GH07	Umber
1GH08	Charcoal

#### Method – Maharam

Seating/Workspaces

54" wide

100% recycled polyester

with 12% ocean-bound plastic

40G01/466579-001	Inspire
40G02/466579-002	Rhea
40G03/466579-003	Noise
40G04/466579-004	Speedway
40G05/466579-005	Villanelle
40G06/466579-006	Maestro
40G07/466579-007	Destiny
40G08/466579-008	Possess
40G09/466579-009	Waterside
40G10/466579-010	Relax
40G11/466579-011	Delightful
40G12/466579-012	Parrotlet
40G13/466579-013	Verdurous
40G14/466579-014	Bosky
40G15/466579-015	Acreage
40G16/466579-016	Allude
40G17/466579-017	Tweed
40G18/466579-018	Korma
40G19/466579-019	Fossilize
40G20/466579-020	Cattail
40G21/466579-021	Shortcake
40G22/466579-022	Racecar
40G23/466579-023	Courtship
40G24/466579-024	Jam
40G25/466579-025	Sparrow

#### Nico - Maharam

Ancillary/Seating/Workspaces

54" wide

63% wool

21% polyester

16% solution-dyed nylon

ZNC01/466564-001	Alcazar
ZNC02/466564-002	Ironclad
ZNC03/466564-003	Tune
ZNC04/466564-004	Bridegroom
ZNC05/466564-005	Diode
ZNC06/466564-006	Jest

#### Nico continued

ZNC07/466564-007	Sanctuary
ZNC08/466564-008	Aquarius
ZNC09/466564-009	Houseboat
ZNC10/466564-010	Olympian
ZNC11/466564-011	Tennis
ZNC12/466564-012	Dressage
ZNC13/466564-013	Zing
ZNC14/466564-014	Bitterroot
ZNC15/466564-015	Gemini
ZNC16/466564-016	Posh
ZNC17/466564-017	Sizzle
ZNC18/466564-018	Cheerful
ZNC19/466564-019	Watermelon
ZNC20/466564-020	Toucan
ZNC21/466564-021	Rosin
ZNC22/466564-022	Jousting
ZNC23/466564-023	Jojoba
ZNC24/466564-024	Dromedary
ZNC25/466564-025	Toasty
ZNC26/466564-026	Casaba
ZNC27/466564-027	Greenhouse
ZNC28/466564-028	Sibyl
ZNC29/466564-029	Spearmint
ZNC30/466564-030	Pothos
ZNC31/466564-031	Calathea
ZNC32/466564-032	Landscape
ZNC33/466564-033	Espalier
ZNC34/466564-034	Gecko
ZNC35/466564-035	Meditation

#### Summit

Ancillary/Seating

54" wide

100% silicone

Polyester knit backing

3SU02	Oyster
3SU03	Zinc
3SU04	Sparrow
3SU07	Black
3SU09	Beachglass
3SU10	Midnight

#### Vionette - Geiger Textile

Ancillary

55" wide

100% polyester

1GJ01	White Sand Mix
1GJ02	Desert Mix
1GJ03	Light Gray Mix
1GJ04	Pewter Mix
1GJ05	Cobalt Mix
1GJ06	Prussian Blue Mix
1GJ07	Chocolate Mix
1GJ08	Champagne
1GJ09	Morning Sky
1GJ10	Aquatic
1GJ11	Sapphire
1GJ12	Midnight Blue
1GJ13	Shadow
1GJ14	Java
1GJ15	Carbon
1GJ16	Black
1GJ17	Claret
1GJ18	Poppy



# Textile Colors

continued

GSA

## Price Category 6

Balance	
Seating	
For Embody® chairs	
100% polyester	
3512	Carbon
3513	Black

Outdoor Weave	
Ancillary	
For Eames® Aluminum Group	
Outdoor Chairs	
50% elastomeric	
50% polypropylene	
7203	Lead
7205	Graphite

## Price Category 7

Customer's Own Leather
Seating/Ancillary
See Order Information in
Appendices. Assigned lead-time
textile. <a href="#">A</a>

Beck – Maharam
Ancillary/Seating
55" wide
78% wool
22% nylon
ZB301/466571-001 Overshadow
ZB302/466571-002 Molecule
ZB303/466571-003 Zeitgeist
ZB304/466571-004 Blacksmith
ZB305/466571-005 Cornerstone
ZB306/466571-006 Chainmail
ZB307/466571-007 Buckram
ZB308/466571-008 Callisto
ZB309/466571-009 Interlude
ZB310/466571-010 Letterpress
ZB311/466571-011 Memoir
ZB312/466571-012 Litmus
ZB313/466571-013 Stoic
ZB314/466571-014 Inkpad
ZB315/466571-015 Praxis
ZB316/466571-016 Astute
ZB317/466571-017 Percolate
ZB318/466571-018 Halocline
ZB319/466571-019 Semblance
ZB320/466571-020 Loch
ZB321/466571-021 Lido
ZB322/466571-022 Underwater
ZB323/466571-023 Tetrapod
ZB324/466571-024 Nymph
ZB325/466571-025 Appalachian
ZB326/466571-026 Menthol
ZB327/466571-027 Woodruff
ZB328/466571-028 Malachite
ZB329/466571-029 Botanist
ZB330/466571-030 Woodlet
ZB331/466571-031 Katydid
ZB332/466571-032 Exuberant
ZB333/466571-033 Retrospect

Beck continued
ZB334/466571-034 Lambic
ZB335/466571-035 Argil
ZB336/466571-036 Brushstroke
ZB337/466571-037 Candescant
ZB338/466571-038 Reedbuck
ZB339/466571-039 Clayware
ZB340/466571-040 Curio
ZB341/466571-041 Whimsy
ZB342/466571-042 Effervescent
ZB343/466571-043 Lingonberry
ZB344/466571-044 Resplendent
ZB345/466571-045 Hollyhock
ZB346/466571-046 Filigree
ZB347/466571-047 Plutonic
ZB348/466571-048 Foundry
ZB349/466571-049 Patisserie
ZB390 Gold 007/032/033 *
ZB391 Russet 036/040/039 *
ZB392 Indigo 008/013/014 *
ZB393 Forest 006/031/028 *

\* Colors available only on Girard Color Wheel Ottoman.

Bellano - Geiger Textile
Ancillary
55" wide
75% wool
10% linen
8% nylon
7% alpaca
1AX01 Pearl
1AX02 Fog
1AX03 Fawn
1AX04 Pumice
1AX05 Pewter
1AX06 Atlantic
1AX07 Black Green
1AX08 Adriatic
1AX09 Coffee
1AX10 Charcoal
1AX11 Umber
1AX12 Magenta
1AX13 Bittersweet
1AX14 Sunflower

Capri - Geiger Textile
Ancillary
55" wide
36% cotton
32% acrylic
24% rayon
8% polyester
PFOA-Free stain resistant finish
Acrylic backing
17201 Snow
17202 Stone
17203 Trench
17204 Graphite
17205 Anthracite
17206 Light Silver
17207 Russet
17208 Chestnut Brown
17209 Sand
17210 Sterling
17211 Cobalt
17212 Ink

Mantle - Maharam
Ancillary/Seating
59% recycled polyester
37% polyester
4% spandex
8PV01 Pavement
8PV02 Future
8PV03 Piper
8PV04 Manifesto
8PV05 Mapo
8PV06 Redwood
8PV07 Rocky
8PV08 Impala
8PV09 Warbler
8PV10 Guild
8PV11 Kinetic
8PV12 Behold
8PV13 Orb
8PV14 Sport
8PV15 Utopia
8PV16 True
8PV17 Galore

Price category 7 continued on next page

# Textile Colors

continued

## GSA

### Price Category 7

continued

#### Mantle continued

8PV18	Parsley
8PV19	Dare
8PV20	Branzino
8PV21	Network
8PV22	Standard
8PV23	Salamander
8PV24	Oscillate

#### Milaner - Geiger Textile

Ancillary
55" wide
56% wool, 10% acrylic
10% alpaca, 10% cotton
8% nylon, 6% rayon

17101	Linen
17102	Flax
17103	Bark
17104	Deep Navy
17105	Charcoal
17106	Medium Grey
17107	Ash
17108	Crimson

#### Panno di Dolce - Geiger Textile

Ancillary	
55" wide	
65% wool	
20% nylon	
15% alpaca	
1AV01	Fog
1AV02	Dune
1AV03	Trench
1AV04	Flannel
1AV05	Charcoal
1AV06	Umber
1AV07	Deep Navy
1AV08	Graphite
1AV09	Orange
1AV10	Pink
1AV11	Deep Red
1AV12	Bright Green
1AV13	Cerulean Blue
1AV14	Deep Cerulean Blue

#### Resca - Geiger Textile

Ancillary
56" wide
75% wool
10% linen
8% nylon
7% alpaca

1AW01	Fog
1AW02	Dune
1AW03	Trench
1AW04	Flannel
1AW05	Umber
1AW06	Bordeaux

#### Rowan - Maharam

Ancillary/Seating
77% wool
12% nylon
6% acrylic
5% linen

5K301	Kingdom
5K302	Northern
5K303	Rabbit
5K304	Elephant
5K305	Furrow
5K306	Heirloom
5K307	Appear
5K308	Repose
5K309	Blackcurrant
5K310	Courage
5K311	Bordeaux
5K312	Cherish
5K313	Brickfield
5K314	Hibiscus
5K315	Carnelian
5K316	Cinnabar
5K317	Toasted
5K318	Revea
5K319	Cortado
5K320	Medallion
5K321	Polenta
5K322	Prized
5K323	Travertine
5K324	Companion
5K325	Library
5K326	Fable

#### Rowan continued

5K327	Pixie
5K328	Arboretum
5K329	Ease
5K330	Sapling
5K331	Cottonwood
5K332	Scout
5K333	Valleyside
5K334	Ornament
5K335	Zucchini
5K336	Ethereal
5K337	Springtide
5K338	Traverse
5K339	Untold
5K340	Flowing
5K341	Laguna
5K342	Cerulean
5K343	Soundscape
5K344	Message
5K345	Freefall
5K346	Musical
5K347	Puzzle
5K348	Operatic
5K349	Daydream
5K350	Shale
5K351	Forward
5K352	Anthracite

#### Wool Tweed - Geiger Textile

Ancillary	
54" wide	
80% wool, 20% nylon	
16601	Trench
16602	Pewter
16603	Ruby
16604	Blue Gray
16605	Navy
16606	Umber
16607	Charcoal

### Price Category 8

#### Luca - Maharam

Ancillary/Seating	
59" wide	
75% post-consumer recycled wool	
20% polyester	
5% nylon	
ZLU01/466566-001	Brioche
ZLU02/466566-002	Blanched
ZLU03/466566-003	Relic
ZLU04/466566-004	Sinter
ZLU05/466566-005	Scoria
ZLU06/466566-006	Austere
ZLU07/466566-007	Pigment
ZLU08/466566-008	Alkali
ZLU09/466566-009	Tidal
ZLU10/466566-010	Imbue
ZLU11/466566-011	Reservoir
ZLU12/466566-012	Brine
ZLU13/466566-013	Undertone
ZLU14/466566-014	Prelude
ZLU15/466566-015	Submerge
ZLU16/466566-016	Cypress
ZLU17/466566-017	Awash
ZLU18/466566-018	Adriatic
ZLU19/466566-019	Province
ZLU20/466566-020	Virescent
ZLU21/466566-021	Nettle
ZLU22/466566-022	Agrarian
ZLU23/466566-023	Serpentine
ZLU24/466566-024	Laurel
ZLU25/466566-025	Clarion
ZLU26/466566-026	Gooseberry
ZLU27/466566-027	Swelter
ZLU28/466566-028	Etruscan
ZLU29/466566-029	Coulis
ZLU30/466566-030	Rubescient
ZLU31/466566-031	Akoya
ZLU32/466566-032	Radiant
ZLU33/466566-033	Regent
ZLU34/466566-034	Spectral
ZLU35/466566-035	Thistle



# Textile Colors

continued

## GSA

### Price Category 9

Gemma – Maharam	
Ancillary/Seating	
55" wide	
85% wool	
15% nylon	
ZGE01/466568-001	Crinoline
ZGE02/466568-002	Angelic
ZGE03/466568-003	Savory
ZGE04/466568-004	Honeycomb
ZGE05/466568-005	Gilded
ZGE06/466568-006	Paddleboat
ZGE07/466568-007	Stagecoach
ZGE08/466568-008	Waterbuck
ZGE09/466568-009	Earnest
ZGE10/466568-010	Auric
ZGE11/466568-011	Carmine
ZGE12/466568-012	Serape
ZGE13/466568-013	Ferric
ZGE14/466568-014	Canyon
ZGE15/466568-015	Alembic
ZGE16/466568-016	Patio
ZGE17/466568-017	Sorrel
ZGE18/466568-018	Root
ZGE19/466568-019	Mansion
ZGE20/466568-020	Buff
ZGE21/466568-021	Starch
ZGE22/466568-022	Dawn
ZGE23/466568-023	Countryside
ZGE24/466568-024	Dewy
ZGE25/466568-025	Reliquary
ZGE26/466568-026	Deluge
ZGE27/466568-027	Overlay
ZGE28/466568-028	Electron
ZGE29/466568-029	Sheath
ZGE30/466568-030	Quietude
ZGE31/466568-031	Jargon
ZGE32/466568-032	Powder
ZGE33/466568-033	Tide
ZGE34/466568-034	Outwash
ZGE35/466568-035	Enamored
ZGE36/466568-036	Smitten
ZGE37/466568-037	Revere
ZGE38/466568-038	Mangosteen
ZGE39/466568-039	Allium
ZGE40/466568-040	Immense

Gemma continued	
ZGE41/466568-041	Chamber
ZGE42/466568-042	Cosmos
ZGE43/466568-043	Inkling
ZGE44/466568-044	Rainwater
ZGE45/466568-045	Shade
ZGE46/466568-046	Pendant
ZGE47/466568-047	Axial
ZGE48/466568-048	Fervent
ZGE49/466568-049	Legacy
ZGE50/466568-050	Caliber
ZGE51/466568-051	Temple
ZGE52/466568-052	Evenfall

Jasper - Maharam	
Seating	
53" wide	
55% wool	
27% solution-dyed nylon	
18% cotton	
ZJA01/466563-001	Thrill
ZJA02/466563-002	Anise
ZJA03/466563-003	Grapefruit
ZJA04/466563-004	Lifeguard
ZJA05/466563-005	Heartfelt
ZJA06/466563-006	Corsage
ZJA07/466563-007	Earthenware
ZJA08/466563-008	Bear
ZJA09/466563-009	Firelight
ZJA10/466563-010	Dreamcatcher
ZJA11/466563-011	Bobcat
ZJA12/466563-012	Glacial
ZJA13/466563-013	Vaporize
ZJA14/466563-014	Trapdoor
ZJA15/466563-015	Halcyon
ZJA16/466563-016	Observatory
ZJA17/466563-017	Steamboat
ZJA18/466563-018	Aquathlon
ZJA19/466563-019	Cloudless
ZJA20/466563-020	Briny
ZJA21/466563-021	Magical
ZJA22/466563-022	Picnic
ZJA23/466563-023	Herbage
ZJA24/466563-024	Pasture
ZJA25/466563-025	Courtyard
ZJA26/466563-026	Leapfrog

Leather	
Ancillary/Seating	
approx. 50 sq. ft. per hide	
100% leather	
2101	Ivory
2109	Black *
2110	Smoke
2111	Graphite
2112	Khaki
2113	Rattan
2114	Truffle
2115	Alpine
2116	Haze
2117	Sable Grey
2118	Dark Mineral **
2119	Dark Carbon ***
2120	Cranberry
2121	Deep Sea

\* Armpad color available on Aeron® Chair, Graphite.  
 \*\* Armpad color available on Aeron Chair, Mineral.  
 \*\*\* Armpad color available on Aeron Chair, Carbon.

### Price Category 10

Bristol Leather - Geiger Textile	
Ancillary	
approx. 55 sq. ft. per hide	
100% leather	
5-507	Black
5-511	Putty
5-519	Hunter
5-520	White
5-521	Ivory
5-522	Parchment
5-537	Caribbean
5-546	Pumice
5-547	Smoke
5-548	Charcoal
5-549	Dark Shale
5-556	Downtown Grey
5-557	City Night
5-559	Ash Grey
5-563	Champagne
5-564	Chestnut Brown
5-565	Dark Sienna
5-566	Earthen
5-567	Desert
5-568	British Green
5-579	Paris Blue
5-583	Atlantic
5-592	Camel
5-594	Taupe
5-597	Pure
5-598	Cream
5-600	Midnight Blue
5-603	Sangria
5-604	Swiss Red
5-605	Nordic Yellow
5-606	Sky Grey
5-608	Natural

Price category 10 continued on next page

# Textile Colors

continued

## GSA

### Price Category 10

continued

Appendix: Textile Colors

Firma – Maharam	Gemma Multi – Maharam	Gemma Multi <i>continued</i>	Gemma Multi Reverse <i>continued</i>
Ancillary/Seating	Ancillary/Seating	ZGF41/466569-041 Shandy	ZGF68/466569-111 Cabaret
55" wide	55" wide	ZGF42/466569-042 Granary	Reverse
78% wool	85% wool	ZGF43/466569-043 Percolate	ZGF69/466569-112 Candytuft
22% nylon	15% nylon	ZGF44/466569-044 Motor	Reverse
3KH01/466582-001 Wrath	ZGF01/466569-001 Andromeda	ZGF45/466569-045 Unicorn	ZGF70/466569-113 Juice
3KH02/466582-002 Pantomime	ZGF02/466569-002 Dappled	ZGF46/466569-046 Lobster	Reverse
3KH03/466582-003 Shaded	ZGF03/466569-003 Lyra	ZGF47/466569-047 Rhododendron	ZGF71/466569-114 Fairground
3KH04/466582-004 Prologue	ZGF04/466569-004 Flaunt	ZGF48/466569-048 Taffy	Reverse
3KH05/466582-005 Framework	ZGF05/466569-005 Celluloid	ZGF49/466569-049 Rishi	ZGF72/466569-115 Copperplate
3KH06/466582-006 Railroad	ZGF06/466569-006 Hydrozoa	ZGF50/466569-050 Backcountry	Reverse
3KH07/466582-007 Grommet	ZGF07/466569-007 Firefly	ZGF51/466569-051 Buckthorn	ZGF73/466569-116 Sunbird
3KH08/466582-008 Lunisolar	ZGF08/466569-008 Pisces	ZGF52/466569-052 Coniferous	Reverse
3KH09/466582-009 Snowpack	ZGF09/466569-009 Strath	ZGF53/466569-053 Delphic	ZGF74/466569-117 Cinematic
3KH10/466582-010 Coldsnap	ZGF10/466569-010 Erosion	ZGF54/466569-054 Hieroglyph	Reverse
3KH11/466582-011 Sealift	ZGF11/466569-011 Cabaret	ZGF55/466569-055 Eiderdown	ZGF75/466569-118 Clairvoyant
3KH12/466582-012 Brood	ZGF12/466569-012 Candytuft	ZGF56/466569-056 Sandbar	Reverse
3KH13/466582-013 Intertidal	ZGF13/466569-013 Juice	ZGF57/466569-057 Tanager	ZGF76/466569-119 Crocus
3KH14/466582-014 Confide	ZGF14/466569-014 Fairground		Reverse
3KH15/466582-015 Secluded	ZGF15/466569-015 Copperplate	Gemma Multi Reverse – Maharam	ZGF77/466569-120 Memoir
3KH16/466582-016 Leisure	ZGF16/466569-016 Sunbird	Ancillary/Seating	Reverse
3KH17/466582-017 Portfolio	ZGF17/466569-017 Cinematic	55" wide	ZGF78/466569-121 Roulette
3KH18/466582-018 Strato	ZGF18/466569-018 Clairvoyant	85% wool	Reverse
3KH19/466582-019 Fogbow	ZGF19/466569-019 Crocus	15% nylon	ZGF79/466569-122 Voltaic
3KH20/466582-020 Snowcone	ZGF20/466569-020 Memoir	ZGF58/466569-101 Andromeda	Reverse
3KH21/466582-021 Kazoo	ZGF21/466569-021 Roulette	Reverse	ZGF80/466569-123 Compote
3KH22/466582-022 Esteem	ZGF22/466569-022 Voltaic	ZGF59/466569-102 Dappled	Reverse
3KH23/466582-023 Mackerel	ZGF23/466569-023 Compote	Reverse	ZGF81/466569-124 Lambent
3KH24/466582-024 Brooch	ZGF24/466569-024 Lambent	ZGF60/466569-103 Lyra	Reverse
3KH25/466582-025 Caesious	ZGF25/466569-025 Twister	Reverse	ZGF82/466569-125 Twister
3KH26/466582-026 Islet	ZGF26/466569-026 Chronicle	ZGF61/466569-104 Flaunt	Reverse
3KH27/466582-027 Biosphere	ZGF27/466569-027 Sidereal	Reverse	ZGF83/466569-126 Chronicle
3KH28/466582-028 Hilltop	ZGF28/466569-028 Tanzanite	ZGF62/466569-105 Celluloid	Reverse
3KH29/466582-029 Arboreal	ZGF29/466569-029 Crystalize	Reverse	ZGF84/466569-127 Sidereal
3KH30/466582-030 Lineage	ZGF30/466569-030 Chromium	ZGF63/466569-106 Hydrozoa	Reverse
3KH31/466582-031 Comfrey	ZGF31/466569-031 Pallium	Reverse	ZGF85/466569-128 Tanzanite
3KH32/466582-032 Circe	ZGF32/466569-032 Spectre	ZGF64/466569-107 Firefly	Reverse
3KH33/466582-033 Ecosystem	ZGF33/466569-033 Courgette	Reverse	ZGF86/466569-129 Crystalize
3KH34/466582-034 Knack	ZGF34/466569-034 Viper	ZGF65/466569-108 Pisces	Reverse
3KH35/466582-035 Watt	ZGF35/466569-035 Sunlit	Reverse	ZGF87/466569-130 Chromium
3KH36/466582-036 Epiphany	ZGF36/466569-036 Heavenly	ZGF66/466569-109 Strath	Reverse
3KH37/466582-037 Gamma	ZGF37/466569-037 Vernal	Reverse	ZGF88/466569-131 Pallium
3KH38/466582-038 Toxicab	ZGF38/466569-038 Cress	ZGF67/466569-110 Erosion	Reverse
3KH39/466582-039 Varietal	ZGF39/466569-039 Limn	Reverse	ZGF89/466569-132 Spectre
	ZGF40/466569-040 Horseradish		Reverse

Price category 10 continued on next page

# Textile Colors

continued

## GSA

### Price Category 10

continued

#### Gemma Multi Reverse *continued*

ZGF90/466569-133	Courgette
	Reverse
ZGF91/466569-134	Viper
	Reverse
ZGF92/466569-135	Sunlit
	Reverse
ZGF93/466569-136	Heavenly
	Reverse
ZGF94/466569-137	Vernal
	Reverse
ZGF95/466569-138	Cress
	Reverse
ZGF96/466569-139	Limn
	Reverse
ZGF97/466569-140	Horseradish
	Reverse
ZGF98/466569-141	Shandy
	Reverse
ZGF99/466569-142	Granary
	Reverse
ZGFA0/466569-143	Percolate
	Reverse
ZGFA1/466569-144	Motor
	Reverse
ZGFA2/466569-145	Unicorn
	Reverse
ZGFA3/466569-146	Lobster
	Reverse
ZGFA4/466569-147	Rhododendron
	Reverse
ZGFA5/466569-148	Taffy
	Reverse
ZGFA6/466569-149	Rishi
	Reverse
ZGFA7/466569-150	Backcountry
	Reverse
ZGFA8/466569-151	Buckthorn
	Reverse
ZGFA9/466569-152	Coniferous
	Reverse
ZGFB0/466569-153	Delphic
	Reverse

#### Gemma Multi Reverse *continued*

ZGFB1/466569-154	Hieroglyph
	Reverse
ZGFB2/466569-155	Eiderdown
	Reverse
ZGFB3/466569-157	Tanager
	Reverse

#### Petra - Maharam

Ancillary/Seating	
55" wide	
70% wool	
19% linen	
11% nylon	
ZP401/466580-001	Hieroglyph
ZP402/466580-002	Interior
ZP403/466580-003	Samovar
ZP404/466580-004	Calcite
ZP405/466580-005	Silversmith
ZP406/466580-006	Rivet
ZP407/466580-007	Carpolite
ZP408/466580-008	Bonbon
ZP409/466580-009	Dreamy
ZP410/466580-010	Bejewel
ZP411/466580-011	Sashimi
ZP412/466580-012	Spirula
ZP413/466580-013	Chalet
ZP414/466580-014	Reindeer
ZP415/466580-015	Nostalgia
ZP416/466580-016	Trove
ZP417/466580-017	Narcissus
ZP418/466580-018	Yurt
ZP419/466580-019	Congee
ZP420/466580-020	Genepy
ZP421/466580-021	Herbaceous
ZP422/466580-022	Paddock
ZP423/466580-023	Precious
ZP424/466580-024	Biome
ZP425/466580-025	Tinted
ZP426/466580-026	Pelagic
ZP427/466580-027	Bluebill
ZP428/466580-028	Chicory
ZP429/466580-029	Eaglet
ZP430/466580-030	Permafrost
ZP431/466580-031	Atlantic
ZP432/466580-032	Airstream
ZP433/466580-033	Debonair

### Price Category 11

#### Felix - Maharam

Ancillary/Seating	
85% wool	
15% nylon	
3BS01	Angular
3BS02	Shark
3BS03	Easy
3BS04	Cue
3BS05	Rye
3BS06	Champion
3BS07	Between
3BS08	Propose
3BS09	Rising
3BS10	Tile
3BS11	Place
3BS12	Kernel
3BS13	Pinnacle
3BS14	Darling
3BS15	Seasonal
3BS16	Shipmate
3BS17	Jump
3BS18	Geyser
3BS19	Team

#### Prone Leather - Maharam

Ancillary	
approx. 50 sq. ft. per hide	
100% leather	
protective top coat	
1NX01/700020-001	Lotus
1NX02/700020-002	Timbre
1NX03/700020-003	Essence
1NX04/700020-004	Script
1NX05/700020-005	Gambit
1NX06/700020-006	Obsidian
1NX07/700020-007	Sail
1NX09/700020-009	Vine
1NX10/700020-010	Yarrow
1NX13/700020-013	Balsa
1NX14/700020-014	Shore
1NX15/700020-015	Bricolage
1NX17/700020-017	Ledge
1NX19/700020-019	Mantra
1NX20/700020-020	Java
1NX21/700020-021	Lute
1NX22/700020-022	Glow
1NX23/700020-023	Hickory

### Price Category A

No fabrics available at this time.

Appendix: Textile Colors

# Textile Colors

continued

GSA

Appendix: Textile Colors

## Price Category B

Medium – Maharam	
Ancillary/Seating/Workspaces	
54" wide	
100% polyester	
VM01/463490-001 Raven	
VM02/463490-002 Smoke	
VM03/463490-003 Alloy	
VM04/463490-004 Flax	
VM07/463490-007 Espresso	
VM14/463490-014 Laser	
VM16/463490-016 Port	
VM22/463490-022 Marina	
VM29/463490-029 Pistachio	
VM32/463490-032 Prospect	
VM36/463490-036 Delight	
VM39/463490-039 Nautical	
VM40/463490-040 Pool	
VM44/463490-044 Washed	
VM45/463490-045 Sculpture	
VM46/463490-046 Thatched	
VM47/463490-047 Hike	
VM48/463490-048 Tangle	
VM49/463490-049 Pacific	
VM50/463490-050 Cosmic	
VM53/463490-053 Nasturtium	
Messenger – Maharam	
Ancillary/Seating/Workspaces	
54" wide	
78% post-industrial recycled polyester	
15% polyester	
7% nylon	
TI07/458640-007 Shadow	
TI08/458640-008 Bayou *	
TI24/458640-024 Poppy	
TI25/458640-025 Mao	
TI29/458640-029 Onyx *	
TI31/458640-031 Cloud *	
TI38/458640-038 Depth *	
TI40/458640-040 Nile *	
TI41/458640-041 Azure *	
TI45/458640-045 Cactus *	

Messenger continued	
TI46/458640-046 Ice *	
TI48/458640-048 Neon	
TI50/458640-050 Hydrangea	
TI53/458640-053 Tangelo	
TI54/458640-054 Lumine *	
TI58/458640-058 Snow **	
TI60/458640-060 Peridot	
TI61/458640-061 Capri *	
TI62/458640-062 Ultramarine	
TI63/458640-063 Squall	
TI66/458640-066 Cassis	
TI67/458640-067 Aster	
TI69/458640-069 Cherry	
TI70/458640-070 Vibrant	
TI71/458640-071 Satsuma *	
TI72/458640-072 Maize	
TI76/458640-076 Fossil	
TI77/458640-077 Ash	
TI78/458640-078 Tusk	
TI79/458640-079 Oyster **	
TI81/458640-081 Husk	
TI84/458640-084 Robust	
TI85/458640-085 Beyond	
TI86/458640-086 Voyage *	
TI87/458640-087 Everglade	
TI89/458640-089 Blanch **	
TI90/458640-090 Longspur	
TI91/458640-091 Vireo	
TI92/458640-092 Dipper	
TI93/458640-093 Gale	
TI94/458640-094 Hunter	
TI95/458640-095 Lime	
TI96/458640-096 Apple	
TI97/458640-097 Krill	
TI98/458640-098 Catalyst	
* Colors available on 20-day lead time.	
** Colors not available on Eames Molded Fiberglass and Molded Plastic Side Chairs.	

## Price Category C

Manner - Maharam	
Ancillary/Seating/Workspaces	
54" wide	
65% post-industrial recycled polyester	
35% post-consumer recycled polyester	
Z2701/466177-001 Magic	
Z2702/466177-002 Carob	
Z2703/466177-003 Porpoise	
Z2704/466177-004 Flint	
Z2705/466177-005 Hush *	
Z2706/466177-006 Nuance	
Z2711/466177-011 Ember	
Z2712/466177-012 Wagon	
Z2713/466177-013 Ablaze	
Z2714/466177-014 Peel	
Z2716/466177-016 Butterscotch	
Z2717/466177-017 Harvest	
Z2720/466177-020 Parakeet	
Z2722/466177-022 Aquatic	
Z2723/466177-023 Cottage	
Z2724/466177-024 Dahlia	
Z2725/466177-025 Vivid	
Z2726/466177-026 Basin	
Z2727/466177-027 Schooner	
Z2729/466177-029 Silverpoint	
Z2730/466177-030 Lattice	
Z2731/466177-031 Smoky	
Z2732/466177-032 Magnetic	
Z2733/466177-033 Woad	
Z2734/466177-034 Resolute	
Z2735/466177-035 Cruise	
Z2736/466177-036 Atmospheric	
Z2737/466177-037 Cloudburst	
Z2738/466177-038 Tidewater	
Z2739/466177-039 Firth	
Z2740/466177-040 Oceanside	
Z2741/466177-041 Grandeur	
Z2742/466177-042 Comfort	
Z2743/466177-043 Dill	
Z2744/466177-044 Poplar	
Z2745/466177-045 Citronella	
Z2746/466177-046 Passerine	

Manner continued	
Z2747/466177-047 Southwest	
Z2748/466177-048 Roseate	
Z2749/466177-049 Charisma	
Z2750/466177-050 Siltstone	
Z2751/466177-051 Kimono	
Z2752/466177-052 Valiant	
Z2753/466177-053 Baroness	
* Color not available on Eames Aluminum Group, Executive Chairs, Upholstered Molded Plywood Chairs, and Sofa Compact.	
Merit - Maharam	
Seating	
54" wide	
76% post-industrial recycled polyester	
24% polyester	
PFOA-Free stain resistant	
88Z01/466444-001 Trickle	
88Z02/466444-002 Beluga	
88Z03/466444-003 Gunmetal	
88Z04/466444-004 Blackout	
88Z05/466444-005 Superior	
88Z06/466444-006 Ocean	
88Z07/466444-007 Highborn	
88Z08/466444-008 Immersed	
88Z09/466444-009 Rainfall	
88Z10/466444-010 Blizzard	
88Z11/466444-011 Poolside	
88Z12/466444-012 Steel	
88Z13/466444-013 Zircon	
88Z14/466444-014 Ripple	
88Z15/466444-015 Aegean	
88Z16/466444-016 Armada	
88Z17/466444-017 Hedera	
88Z18/466444-018 Rainforest	
88Z19/466444-019 Gator	
88Z20/466444-020 Vineyard	
88Z21/466444-021 Pine	
88Z22/466444-022 Kiwi	
88Z23/466444-023 Kookaburra	

Price category C continued on next page

# Textile Colors

continued

## GSA

### Price Category C

continued

#### Merit continued

88Z24/466444-024	Bellini
88Z25/466444-025	Sunflower
88Z26/466444-026	Sandstorm
88Z27/466444-027	Mudder
88Z28/466444-028	Lynx
88Z29/466444-029	Farro
88Z30/466444-030	Manila
88Z31/466444-031	Starfish
88Z32/466444-032	Brass
88Z33/466444-033	Arrow
88Z34/466444-034	Gelato
88Z35/466444-035	Nectarine
88Z36/466444-036	Macaron
88Z37/466444-037	Alert
88Z38/466444-038	Goji
88Z39/466444-039	Cabernet
88Z40/466444-040	Eggplant
88Z41/466444-041	Hawk
88Z42/466444-042	Stag
88Z43/466444-043	Overcast

#### Metric – Maharam

Seating/Workspaces	
54" wide	
51% post-industrial recycled polyester	
49% polyester	
Z302/466014-002	Fog
Z303/466014-003	Fleece
Z312/466014-012	Cardinal
Z313/466014-013	Lava
Z318/466014-018	Pollen
Z320/466014-020	Alligator
Z323/466014-023	Tar
Z324/466014-024	Anchor
Z326/466014-026	Admiral
Z327/466014-027	Seaport
Z328/466014-028	Scuba
Z329/466014-029	Skate
Z330/466014-030	Hopscotch
Z331/466014-031	Film
Z332/466014-032	Whale
Z333/466014-033	Downpour
Z334/466014-034	Midday

#### Metric continued

Z335/466014-035	Talisman
Z336/466014-036	Hedgerow
Z337/466014-037	Snorkel
Z338/466014-038	Highway
Z339/466014-039	Canary
Z340/466014-040	Sunny
Z341/466014-041	Aztec
Z342/466014-042	Fruit
Z343/466014-043	Galah
Z344/466014-044	Kiln
Z345/466014-045	Moth

#### Murmur - Maharam

Seating	
55" wide	
100% polyester	
PFOA-Free stain resistant	
8EY01/466446-001	Gust
8EY02/466446-002	Harmonica
8EY03/466446-003	Canopy
8EY04/466446-004	Dim
8EY05/466446-005	Peppercorn
8EY06/466446-006	Cauldron
8EY07/466446-007	Conquer
8EY08/466446-008	Rapids
8EY09/466446-009	Seawater
8EY10/466446-010	Baby
8EY11/466446-011	Elderberry
8EY12/466446-012	Iceberg
8EY13/466446-013	Tallgrass
8EY14/466446-014	Underground
8EY15/466446-015	Biome
8EY16/466446-016	Cask
8EY17/466446-017	Argan
8EY18/466446-018	Sundown
8EY19/466446-019	Ignite
8EY20/466446-020	Sultry
8EY21/466446-021	Sangria

### Price Category D

#### Bluff - Maharam

Ancillary/Seating	
54" wide	
100% polyurethane	
Ink-resistant protective top coat	
Polyester backing	
8I801/466489-001	Loom
8I802/466489-002	Helm
8I803/466489-003	Cruller
8I804/466489-004	Folklore
8I805/466489-005	Beguile
8I806/466489-006	Sherpa
8I807/466489-007	Teleport
8I808/466489-008	Annex
8I809/466489-009	Lorimer
8I810/466489-010	Cinema
8I811/466489-011	Zip
8I812/466489-012	Coach
8I813/466489-013	Supernova
8I814/466489-014	Pirate
8I815/466489-015	Academy
8I816/466489-016	Disco
8I817/466489-017	Equator
8I818/466489-018	Brink
8I819/466489-019	Scene
8I820/466489-020	Petrichor
8I821/466489-021	Exotic
8I822/466489-022	Fauna
8I823/466489-023	Calabash
8I824/466489-024	Fuscous
8I825/466489-025	Wildling
8I826/466489-026	Blitz
8I827/466489-027	Allspice
8I828/466489-028	Lumos
8I829/466489-029	Pilot
8I830/466489-030	Jukebox
8I831/466489-031	Dugout
8I832/466489-032	Claret
8I833/466489-033	Flamenco

#### Mode – Maharam

Ancillary/Seating/Workspaces	
54" wide	
80% post-consumer recycled polyester	
20% polyester	
PFOA-Free stain resistant finish	
ZMD01/466337-001	Stroll
ZMD02/466337-002	Intaglio
ZMD03/466337-003	Ominous
ZMD04/466337-004	Machine
ZMD05/466337-005	Talus
ZMD06/466337-006	Marsh
ZMD07/466337-007	Hollow
ZMD08/466337-008	Sycamore
ZMD09/466337-009	Clavicle
ZMD10/466337-010	Billygoat
ZMD11/466337-011	Spindle
ZMD12/466337-012	Lemon
ZMD13/466337-013	Oxeye
ZMD14/466337-014	Henge
ZMD15/466337-015	Goldenrod
ZMD16/466337-016	Cottontail
ZMD17/466337-017	Lioness
ZMD18/466337-018	Oriole
ZMD19/466337-019	Rust
ZMD20/466337-020	Carotene
ZMD21/466337-021	Blush
ZMD22/466337-022	Vermillion
ZMD23/466337-023	Alder
ZMD24/466337-024	Kermes
ZMD25/466337-025	Barberry
ZMD26/466337-026	Petal
ZMD27/466337-027	Valley
ZMD28/466337-028	Odyssey
ZMD29/466337-029	Ballpoint
ZMD30/466337-030	Toile
ZMD31/466337-031	Paradise

Price category D continued on next page



# Textile Colors

continued

## GSA

### Price Category D

continued

### Price Category E

### Price Category F

Appendix: Textile Colors

Mode continued	
ZMD32/466337-032	Angelfish
ZMD33/466337-033	Denim
ZMD34/466337-034	Crush
ZMD35/466337-035	Jetty
ZMD36/466337-036	Saltwater
ZMD37/466337-037	Mallard
ZMD38/466337-038	Celtic
ZMD39/466337-039	Eucalyptus
ZMD40/466337-040	Bonsai
ZMD41/466337-041	Sassafras
ZMD42/466337-042	Yucca
ZMD43/466337-043	Lichen

Spiral - Maharam	
Workspaces	
66" wide	
100% polyester	
ZS301/901882-001	Chalk
ZS303/901882-003	Wheat
ZS304/901882-004	Mica
ZS305/901882-005	Pavement
ZS306/901882-006	Graphite

Article – Maharam	
Ancillary/Seating	
54" wide	
100% vinyl	
ZAT08/458600-008	Marina
ZAT13/458600-013	Flume
ZAT14/458600-014	Storm
ZAT15/458600-015	Toast
ZAT19/458600-019	Fleece
ZAT22/458600-022	Stone
ZAT26/458600-026	Mercury
ZAT29/458600-029	Bluegrass
ZAT31/458600-031	Truffle
ZAT32/458600-032	Gravel
ZAT33/458600-033	Value
ZAT34/458600-034	Tint
ZAT35/458600-035	Snowflake
ZAT36/458600-036	Chalice
ZAT37/458600-037	Trail
ZAT38/458600-038	Pyramid
ZAT39/458600-039	Desert
ZAT40/458600-040	Lei
ZAT41/458600-041	Rouge
ZAT42/458600-042	Karma
ZAT43/458600-043	Opal
ZAT44/458600-044	Periwinkle
ZAT45/458600-045	Vampire
ZAT46/458600-046	Surf
ZAT47/458600-047	Plumage

Micro – Maharam	
Ancillary	
54" wide	
100% vinyl	
ZMB01/466099-001	Muslin
ZMB04/466099-004	Basalt
ZMB06/466099-006	Phantom
ZMB07/466099-007	Depth
ZMB08/466099-008	Cottage
ZMB09/466099-009	Hunter
ZMB11/466099-011	Tomatillo
ZMB12/466099-012	Brew
ZMB14/466099-014	Tang
ZMB15/466099-015	Risk

Parallel – Maharam	
Workspaces	
66" wide	
100% recycled polyester	
TT03/901180-003	Fog
TT22/901180-022	Sterling
TT23/901180-023	Linen
TT24/901180-024	Pea
TT27/901180-027	Boulder
TT28/901180-028	Stream
TT29/901180-029	Shiitake
TT32/901180-032	Brandy
TT33/901180-033	Crater
TT36/901180-036	Quail

Apt – Maharam	
Ancillary/Seating	
54" wide	
100% polyurethane/silicone	
Ink-resistant protective top coat	
Polyester backing	
82T12/466392-012	Iris
82T13/466392-013	Nocturnal
82T14/466392-014	Fluid
82T15/466392-015	Eden
82T16/466392-016	Galactic
82T17/466392-017	Shoreline
82T18/466392-018	Jade
82T19/466392-019	Garden
82T20/466392-020	Botanic
82T21/466392-021	Chartreuse
82T23/466392-023	Lyric
82T24/466392-024	Turmeric
82T25/466392-025	Bengal
82T26/466392-026	Core
82T27/466392-027	Mantle
82T28/466392-028	Sorbet
82T32/466392-032	Oak
82T33/466392-033	Castle
82T34/466392-034	Follow
82T35/466392-035	Elixir
82T36/466392-036	Charm
82T37/466392-037	Descend
82T38/466392-009	Sketch
82T39/466392-010	Glacier
82T40/466392-031	Fortress
82T41/466392-030	Lotus
82T42/466392-001	Coconut
82T43/466392-011	Cobblestone
82T44/466392-029	Bloom
82T45/466392-022	Crepe
82T46/466392-006	Hickory
82T47/466392-007	Constellation
82T48/466392-008	Labyrinth
82T49/466392-002	Vibe
82T50/466392-003	Stampede
82T51/466392-004	Lumber
82T52/466392-005	Gingerbread

Price category F continued on next page

# Textile Colors

continued

## GSA

### Price Category F

continued

Emit – Maharam	
Workspaces	
54” wide	
55% post-industrial recycled polyester	
45% post-consumer recycled polyester	
PFOA-free stain resistant	
8EX01/466378-001	Wed
8EX02/466378-002	Zebra
8EX03/466378-003	Chiffon
8EX05/466378-005	Nectar
8EX06/466378-006	Elk
8EX08/466378-008	Goldenrod
8EX09/466378-009	Beached
8EX10/466378-010	Samba
8EX11/466378-011	Nest
8EX14/466378-014	Groove
8EX17/466378-017	Haiku
8EX18/466378-018	Bluefin
8EX19/466378-019	Flow
8EX20/466378-020	Xenon
8EX21/466378-021	Artem
8EX22/466378-022	Zen
8EX25/466378-025	Limeade

Instill – Maharam	
Ancillary/Seating	
54” wide	
100% polyurethane	
Ink-resistant protective top coat	
Polyester backing	
74M01/466351-001	Page
74M02/466351-002	Limestone
74M03/466351-003	Bobwhite
74M04/466351-004	Loafer
74M07/466351-007	Shaker
74M08/466351-008	Doe
74M09/466351-009	Ride
74M10/466351-010	Squire
74M11/466351-011	Tannin
74M12/466351-012	Vitis
74M14/466351-014	Quail
74M15/466351-015	Brittanic
74M16/466351-016	Narwhal
74M18/466351-018	Stowaway

Instill continued	
74M19/466351-019	Koala
74M20/466351-020	Dorsal
74M21/466351-021	Stealth
74M22/466351-022	Mosey
74M23/466351-023	Beachfront
74M24/466351-024	Discovery
74M25/466351-025	Grasp
74M26/466351-026	Arboreous
74M27/466351-027	Yearling
74M28/466351-028	Allele
74M29/466351-029	Eager
74M30/466351-030	Rise
74M31/466351-031	Latte
74M32/466351-032	Compose
74M33/466351-033	Furrow
74M34/466351-034	Tenor
74M35/466351-035	Annatto
74M36/466351-036	Together
74M37/466351-037	Intention
74M38/466351-038	Overnight
74M39/466351-039	Icecap
74M40/466351-040	Metamorphic
74M41/466351-041	Anthracite

Keen - Maharam	
Seating	
54” wide	
61% polyester	
39% polyolefin	
PFOA-Free stain resistant	
Acrylic backing	
89N01/466433-001	Gaur
89N02/466433-002	Lock
89N03/466433-003	Elk
89N04/466433-004	Oatmeal
89N05/466433-005	Lakefront
89N06/466433-006	Argent
89N07/466433-007	Coyote
89N08/466433-008	Eventide
89N09/466433-009	Canal
89N10/466433-010	Rosemary
89N11/466433-011	Herb
89N12/466433-012	Ruby
89N13/466433-013	Loganberry

Ledger – Maharam	
Ancillary/Seating	
54” wide	
100% polyurethane	
V9G1/463770-001	001
V9G2/463770-002	002
V9G3/463770-003	003
V9G4/463770-004	004
V9GG/463770-017	017
V9GQ/463770-025	025
V9GS/463770-026	026
V9GU/463770-028	028
V9GV/463770-029	029
V9GW/463770-030	030
V9GX/463770-031	031
V9GY/463770-032	032
V9G18/463770-042	042
V9G19/463770-043	043
V9G20/463770-044	044
V9G21/463770-045	045
V9G22/463770-046	046

Loop - Maharam	
Seating	
57” wide	
48% post-industrial recycled polyester	
26% polyester	
26% post-consumer recycled polyester	
PFOA-Free stain resistant	
Acrylic Backing	
ZLL01/466469-001	Opossum
ZLL02/466469-002	Foundation
ZLL03/466469-003	Naval
ZLL04/466469-004	Buoyant
ZLL05/466469-005	Mockingbird
ZLL06/466469-006	Dynasty
ZLL07/466469-007	Zori
ZLL08/466469-008	Wildfire
ZLL09/466469-009	Floral
ZLL10/466469-010	Penguin

Pepper - Maharam	
Seating	
58” wide	
49% polyester	
41% post-industrial recycled polyester	
10% post-consumer recycled polyester	
PFOA-Free stain resistant	
Acrylic Backing	
8LW01/466486-001	Dojo
8LW02/466486-002	Marengo
8LW03/466486-003	Harlequin
8LW04/466486-004	Pavlova
8LW06/466486-006	Achiote
8LW07/466486-007	Essence
8LW08/466486-008	Genome
8LW09/466486-009	Myriad
8LW10/466486-010	Terrarium

Pitch - Maharam	
Ancillary	
54” wide	
100% vinyl	
ZPC04/466186-004	Pollen
ZPC07/466186-007	Apple
ZPC11/466186-011	Voyage
ZPC12/466186-012	Turquoise
ZPC14/466186-014	Inlet
ZPC15/466186-015	Captain
ZPC16/466186-016	Aura
ZPC17/466186-017	Coastal
ZPC18/466186-018	Fog
ZPC19/466186-019	Coal
ZPC21/466186-021	Mulberry
ZPC24/466186-024	Flame
ZPC26/466186-026	Tumbleweed
ZPC29/466186-029	Subtle
ZPC30/466186-030	Buff

Price category F continued on next page

Appendix: Textile Colors

# Textile Colors

continued

## GSA

Appendix: Textile Colors

### Price Category F

continued

#### Scuba - Maharam

Ancillary	
54" wide	
100% polyurethane	
V9B1/464930-001	Vanilla
V9B5/464930-005	Chinchilla
V9B6/464930-006	Mahogany
V9B7/464930-007	Jet
V9B8/464930-008	Charcoal
V9B9/464930-009	Dolphin
V9BA/464930-010	Drizzle
V9BC/464930-012	Conifer
V9BD/464930-013	Bottle
V9BF/464930-015	Tourmaline
V9BG/464930-016	Sapphire
V9BH/464930-017	Electric
V9BL/464930-020	Cabernet
V9BM/464930-021	Brick
V9BN/464930-022	Coral
V9BP/464930-023	Autumn

#### Strum - Maharam

Seating	
54" wide	
100% polyurethane	
with silver-based antimicrobial	
Z3301/466122-001	Overcast
Z3302/466122-002	Ridge
Z3304/466122-004	Pigeon
Z3307/466122-007	Bur
Z3308/466122-008	Abalone
Z3312/466122-012	Lemongrass

### Price Category G

#### Compound - Maharam

Seating	
54" wide	
100% polyurethane	
silane-based antimicrobial	
ZC201/466196-001	Quartz
ZC203/466196-003	Weathered
ZC204/466196-004	Cliff
ZC205/466196-005	Espresso
ZC206/466196-006	Smolder
ZC207/466196-007	Blaze
ZC208/466196-008	Mandarin
ZC209/466196-009	Maple
ZC210/466196-010	Perennial
ZC211/466196-011	Mountainside
ZC212/466196-012	Tundra
ZC213/466196-013	Manatee
ZC214/466196-014	Marine
ZC215/466196-015	Twilight
ZC216/466196-016	Shelter
ZC217/466196-017	Vessel
ZC218/466196-018	Smoke
ZC219/466196-019	Fog

#### Gild - Maharam

Ancillary/Seating	
54" wide	
100% non-phthalate vinyl	
Ink-resistant protective top coat	
Polyester backing	
8AR01/466432-005	Grapevine
8AR02/466432-009	Frosting
8AR03/466432-007	Smokey
8AR04/466432-003	Skylight
8AR05/466432-011	Sandstone
8AR06/466432-004	Hurricane
8AR07/466432-002	Wreath
8AR08/466432-001	Rainforest
8AR09/466432-012	Fudge
8AR10/466432-010	Lantern
8AR11/466432-006	Planet
8AR12/466432-008	Reflection

#### Sudden - Maharam

Ancillary	
54" wide	
100% polyurethane	
ZSD02/463000-002	002
ZSD03/463000-003	003
ZSD05/463000-005	005
ZSD06/463000-006	006
ZSD07/463000-007	007
ZSD08/463000-008	008
ZSD09/463000-009	009
ZSD10/463000-010	010
ZSD11/463000-011	011
ZSD13/463000-013	013
ZSD15/463000-015	015
ZSD16/463000-016	016
ZSD17/463000-017	017
ZSD18/463000-018	018
ZSD19/463000-019	019
ZSD20/463000-020	020
ZSD24/463000-024	024
ZSD27/463000-027	027
ZSD36/463000-036	036

### Price Category H

#### Circles - Maharam

Ancillary/Seating	
55" wide	
70% cotton	
30% polyester	
ZT01/458310-001	Khaki
ZT02/458310-002	Fatigue
ZT03/458310-003	Document
ZT04/458310-004	Engine

#### Dot Pattern - Maharam

Ancillary/Seating	
55" wide	
71% cotton	
29% polyester	
ZK01/458300-001	Document
ZK02/458300-002	Taupe
ZK04/458300-004	Red
ZK05/458300-005	Navy

#### Regatta - Maharam

Ancillary	
54" wide	
65% solution-dyed acrylic	
35% solution-dyed polyester	
ZRT01/466189-001	Drift
ZRT02/466189-002	Parasol
ZRT04/466189-004	Swell

#### Small Dot Pattern - Maharam

Ancillary/Seating	
55" wide	
71% cotton	
29% polyester	
ZL01/458320-001	Document
ZL02/458320-002	Sand
ZL03/458320-003	Khaki
ZL04/458320-004	Taupe
ZL05/458320-005	Charcoal
ZL06/458320-006	Document
	Reverse
ZL07/458320-007	Red
ZL08/458320-008	Yellow
ZL09/458320-009	Green



# Textile Colors

continued

## GSA

Price Category I	Price Category J-O	Price Category P	Price Category Q
<p><b>Cursive – Maharam</b></p> <p>Seating 54” wide 67% solution-dyed acrylic 33% solution-dyed polyester PFOA-Free stain resistant</p> <p>7CW01/466335-001 Fast 7CW03/466335-003 Beachcomb 7CW05/466335-005 Swift 7CW06/466335-006 Jetstream 7CW07/466335-007 Inkwell 7CW08/466335-008 Rubber</p>	<p>No fabrics available at this time.</p>	<p><b>Layers Vineyard Small – Maharam</b></p> <p>Ancillary 52” wide 92% wool 5% polyester 3% nylon</p> <p>ZLS01/465920-001 Ochre/White ZLS02/465920-002 Scarlet/ Peony ZLS03/465920-003 Taupe/Violet ZLS04/465920-004 Jade/ Turquoise ZLS05/465920-005 Ginger/Rose</p>	<p><b>Brushed Camel – Maharam</b></p> <p>Ancillary 58” wide 100% baby camel hair</p> <p>ZBA01/465977-001 Albino ZBA02/465977-002 Natural</p>

Appendix: Textile Colors

# Textile Colors

continued

## GSA

---

### Price Category R-Z

No fabrics available at this time.

---

### Price Category 10M

#### **Pace Leather – Maharam**

Ancillary

approx. 50 sq. ft. per hide

100% leather

ZPA01/700011-001 Whisper

ZPA02/700011-002 Shy

ZPA03/700011-003 Granite

ZPA04/700011-004 Misty

ZPA05/700011-005 Studio

ZPA06/700011-006 Throne

ZPA07/700011-007 Proper

ZPA08/700011-008 Huron

ZPA09/700011-009 Darkroom

ZPA10/700011-010 Bark

ZPA11/700011-011 Raspberry

ZPA12/700011-012 Sangria

ZPA13/700011-013 Admiral

ZPA14/700011-014 Juniper

ZPA15/700011-015 Regal

ZPA16/700011-016 Vapor

ZPA17/700011-017 Valley

ZPA18/700011-018 Bushel

ZPA19/700011-019 Heirloom

ZPA20/700011-020 Palomino

ZPA21/700011-021 Bamboo

ZPA22/700011-022 Saffron

ZPA23/700011-023 Tearose

ZPA24/700011-024 Canyon

ZPA25/700011-025 Bistro

ZPA26/700011-026 Toffee

ZPA27/700011-027 Rodeo

ZPA28/700011-028 Mudslide

ZPA29/700011-029 Greige

ZPA30/700011-030 Reflection

ZPA31/700011-031 Pure

ZPA32/700011-032 Desert

ZPA33/700011-033 Griffin

ZPA34/700011-034 Urbane

ZPA35/700011-035 Woodrose



For more information about our products and services or to see a list of dealers, please visit us at [HermanMiller.com](http://HermanMiller.com) or call (800) 851 1196.

© 2024 Herman Miller, Inc., Zeeland, Michigan

#### Distribution Rights

Working together since 1956, Herman Miller and Vitra are the authentic sources of designs by Charles and Ray Eames, Alexander Girard, and George Nelson. All the designs shown in this book are protected by law. Herman Miller has obtained all rights to make and sell these designs. Also, Herman Miller holds exclusive worldwide manufacturing and distribution rights for these products with the following exceptions:

Charles and Ray Eames, George Nelson, and Alexander Girard—Worldwide distribution rights for furniture in all areas except Europe and the Middle East. For those areas, please contact Vitra.

Isamu Noguchi—Worldwide distribution rights for the Noguchi Rudder Table. Distribution rights for the Noguchi Table in North America and Central America only. For all other areas, please contact Vitra.

Magis—Exclusive distribution rights in the US and Canada. For all other areas, please contact Magis.

© **HermanMiller**, , Action Office, Aeron, Aside, Canvas Office Landscape, Caper, Cosm, Co/Struc, Eames, Embody, Ethospace, Exclave, Fine-Tune, FlexFront, Formcoat, Ground Cloth, Intent, Layout Studio, Lino, Maharam, Meridian, Mirra, Motia, Nelson, Pellicle, Perspectives, Plex, PostureFit, PostureFit SL, Sayl, Setu, Tu, Verus, Y-Tower and Zeph are among the registered trademarks of Herman Miller, Inc., and its owned subsidiaries.

™ AireWeave, Bubbletack, Canvas Vista, Cellular Suspension, Commend, Compass, Connect, DOT, Durawrap, Everywhere, Flex-Edge, Headway, Hopsak 2, Iota, Keyless Entry, Latitude, Lyris 2, Mora, Multiscrim, Nevi, OE1, OE1 Workspace Collection, Overlay, Renew, Stackable, Swoop, Thrive, TriFlex, Twist and Valor are among the trademarks of Herman Miller, Inc., and its owned subsidiaries.

Chemsurf® is a registered trademark of Wilsonart International.

Corian® is a registered trademark of E.I. du Pont de Nemours and Company Corporation.

FLEXNET™ is a trademark of Milliken & Company.

Floor Saver Glide® is a registered trademark of Carpin Manufacturing, Inc.

Forest Stewardship Council® is a registered trademark of the Forest Stewardship Council A.C. (FSC). We are FSC® certified (FSC® C102895).

FSC® is a registered trademark of the Forest Stewardship Council A.C. (FSC).

MicrobeCare™ is a trademark of Parasol Medical LLC.

Microsoft® and Natural® Keyboard are registered trademarks of Microsoft Corporation.

Place Textiles® is a registered trademark of Place Textiles.