



Prices effective January 6, 2020

Celle® Chairs

Introduction	page 2
Celle® Chairs	3
Work Chair	5
Stool	8
Accessories	11
Appendices	
20-Day or Less/Assigned Lead-Time Order Information	
Casters and Glides	
Fire Retardancy-Seating	
Customer's Own Material/Customer's Own Leather Order Information-Seating	
Proprietary Textiles Application Chart-Seating	
Proprietary Textile Colors-Seating	
Maharam® Application Chart-Seating	
Maharam Colors-Seating	
For the latest materials information, refer to the Materials pages on HermanMiller.com.	

Introduction

A Note on the Organization of This Book

There are a few signals that will help you understand the organization of this book. Once you know them, you should be able to find your way around easily.

Like a newspaper, this book is formatted with columns of text and illustrations that run vertically.

Information wraps from one column to the next and continues for as many pages as it needs to.

Black bars are clues.

A black bar at the top of a page signals the start of information about a product.

This information is divided into two sections, each signaled by a black bar. Product Information includes a description, additional notes, and dimensional drawings. Specification Information, which always begins at the top of a column, includes a series of steps. Each step represents a decision you need to make in order to complete your product number. Steps must be followed sequentially. The number of pages needed to complete information on a product varies; some will be complete in one page; others may fill three or four pages. Just continue going through the steps until you run into the next product, signaled by the black bar at the top of the page.

Black tabs running along the outside edge of the page help you locate what section you are in or what section you want to go to. You can thumb forwards or backwards to find a section; tabs and text appear on both sides of the page.

The additional pages in the back of the book include the appendices and indices. They are signaled by a long black bar running along the outside edge of the page.

The index is presented two ways.

The first index is in alphabetical order by product name. It can be helpful if you are new to the products and numbering scheme or if you are looking for a type of product, such as work chair or round table.

The second index is by product number. It lists, in alphanumeric order, the base product number, typically a five-digit number.

General Information

This book is effective January 6, 2020, subject to change without notice. Products may be purchased from authorized Herman Miller dealers who will quote prices upon request. For more information about our products and services or to see a list of dealers, visit www.HermanMiller.com.

All prices are list prices. Additional services, such as planning services, design, storage, and installation, are not included and must be added to these prices when the additional services are requested.

Illustrations, specifications, and prices are based on the latest information at the time of publication. The right is reserved to make changes at any time without notice in prices, fabrics, finishes, materials, specifications, and models, and also to discontinue models and finishes.

Dimensions shown in the drawings are engineering drawing dimensions rounded up to the nearest $\frac{1}{8}$ ". Product is shipped set up or knocked down. Products that include "Shipped knocked down" in the description require some assembly. If this statement does not appear in the description, the product is shipped assembled.

Service problems are normally handled by a Herman Miller authorized dealer. Where this cannot be accomplished on a local level, service problems should be referred to the Customer Care Representative for your region, Herman Miller, Inc., Zeeland, Michigan 49464.

20-Day or Less/Assigned Lead-Time Shipments

All products and options in this price book not designated by an Assigned Program icon  will ship in **20 business days or less** after being acknowledged by Herman Miller.

Products and options designated by an  are on the assigned lead-time program and may ship in 20 days, less than 20 days, or more than 20 days from order acknowledgement.

Work Chairs

Stools

Accessories

Work Chair

CJ111
CJ112
CJ113
CJ121
CJ122
CJ123
CJ131
CJ132
CJ133



Product Information

Description

This chair has a Cellular Suspension™ seat and back material that is lightweight and breathable. The material evenly distributes the user's weight over the seat and allows the back to provide flexible and continuous support. The Harmonic™ tilt provides continuous balance and lets the body recline naturally, pivoting at the ankles, knees, and hips. The chair has a 5-star base and 3 height-adjustment options: the low-height option has a seat-height range of 15" to 19"; the standard-height option has a seat-height range of 15½" to 20¼"; the high-height option has a seat-height range of 16½" to 21¼".

Tilt options include a standard tilt, tilt limiter, and tilt limiter and seat angle. The tilt limiter allows the user to set the tilt range to limit the amount of recline. The tilt limiter and seat angle allows the user to select the tilt range and either a horizontal or 5° forward seat angle.

Back options include a standard version and a user-adjustable lumbar support version. The adjustable lumbar support adjusts 4" in height and 1" in depth. Both back options include passive PostureFit® at the base of the back, below the beltline, that helps achieve healthier posture and improved lower back comfort.

Upholstered options include an upholstered contoured foam cushion seat with a Cellular Suspension™ back or upholstered back.

Seat options include a 15½" fixed seat depth or an adjustable seat depth that adjusts from 15½" to 18".

Arm choices include no arms, fixed arms, or 3-dimensional adjustable arms. Each arm adjusts 4" vertically and 1" horizontally. Armpads pivot 11° outward and 11° inward.

This product meets TB 117-2013.

A vinyl protective edge is applied to upholstered seat cushions to minimize the effects of contact between the chair and furniture with sharp edges in small work stations.

Notes

Chair is tested and warranted for use by persons 350 pounds and under.

Protective edge recommended for healthcare applications.

For information on casters and glides, see Casters and Glides in Appendices.

Customer's Own Material (COM)/Customer's Own Leather (COL) for upholstered cushion seat requires the following:

Seat option—COM—COL

UC—.81 yards—6 square feet

HC—.81 yards—6 square feet

UF (seat only)—.81 yards—6 square feet

HF (seat only)—.81 yards—6 square feet

See Order Information in Appendices.

Dimensions

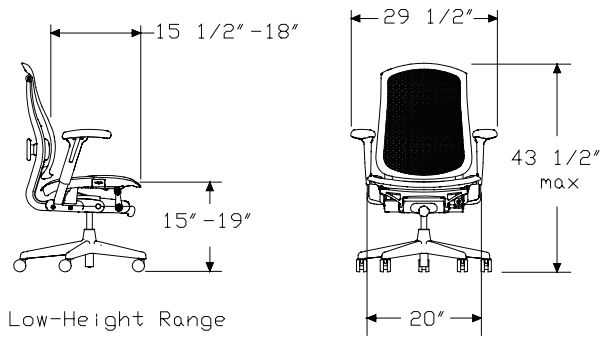

Low-Height Range

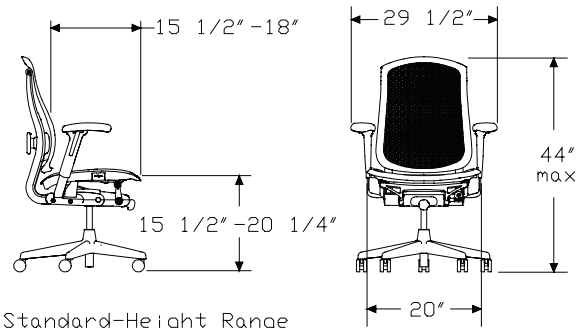

Standard-Height Range

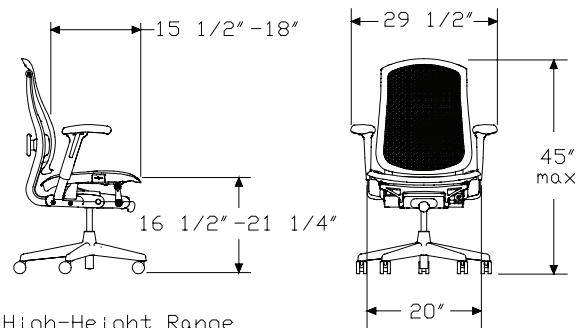

High-Height Range

Specification Information		
Step 1.		
CJ1		
Step 2. Height Adjustment		
1	low-height range	+\$724
2	standard-height range	+\$724
3	high-height range	+\$777
Step 3. Tilt		
1	standard tilt	+\$0
2	tilt limiter	+\$40
3	tilt limiter and seat angle	+\$85
Step 4. Arms		
N	no arms	+\$0
P	fixed arms	+\$100
A	adjustable arms	+\$165
Step 5. Seat-Depth Adjustment		
F	fixed seat depth	+\$0
A	adjustable seat depth	+\$80
Step 6. Seat/Back Material		
CC	Cellular Suspension™ seat and back	+\$0
UC	upholstered cushion seat, Cellular Suspension™ back	+\$43
HC	upholstered cushion seat with protective edge, Cellular Suspension™ back A	+\$69
UF	upholstered cushion seat, upholstered back	+\$133
HF	upholstered cushion seat with protective edge, upholstered back A	+\$152
Step 7. Fire Retardancy		
<i>For not fire retardant (*), skip this step.</i>		
	not fire retardant	+\$0
Step 8. Back Support Option		
N2	no additional support	+\$0
AJ	adjustable lumbar support	+\$50
Step 9. Base/Frame Finish		
3G	brownstone	+\$0
G1	graphite	+\$0

Step 10. Casters/Glides		
BB	2½" hard caster, black yoke, carpet only	+\$0
GF	2½" glide, hard floors or carpet	+\$25
C7	2½" caster, black yoke, hard floors or carpet	+\$50
C9	2½" braking caster, black yoke, hard floors or carpet	+\$50
Step 11. Seat Finish		
<i>For Cellular Suspension™ seat and back (CC) with not fire retardant</i>		
G1	graphite	+\$0
Step 12. Back Finish		
G1	graphite	+\$0
Step 13. Armpad Finish		
<i>For fixed arms (P) or adjustable arms (A)</i>		
3G	brownstone	+\$0
BK	black	+\$0
Step 14. Fabric Seat		
<i>See application chart and textiles list for fabric usage and numbers. First 2 digits of number indicate fabric line; remaining digit(s) indicate fabric color.</i>		
<i>For upholstered cushion seat, Cellular Suspension™ back (UC) with not fire retardant</i>		
	Price Category 1	+\$0
	Price Category 2	+\$11
	Price Category 3	+\$22
	Price Category 4	+\$42
	Price Category 5	+\$70
	Price Category 7 A	+\$132
	Price Category 9	+\$218
	Price Category B	+\$32
	Price Category C	+\$44
	Price Category D	+\$56
	Price Category E	+\$67
	Price Category F	+\$87
	Price Category G	+\$113
	Price Category H	+\$137
	Price Category I	+\$161
	Price Category J	+\$185
	Price Category K	+\$209
	Price Category L	+\$233
	Price Category M	+\$257

For upholstered cushion seat with protective edge, Cellular Suspension™ back (HC) with not fire retardant

Price Category 5	+\$70
Price Category 1	+\$0
Price Category 2	+\$11
Price Category 3	+\$22
Price Category 4	+\$42
Price Category B	+\$32
Price Category C	+\$44
Price Category E	+\$67
Price Category F	+\$87
Price Category G	+\$113
Price Category H	+\$137
Price Category I	+\$161

For upholstered cushion seat with protective edge, upholstered back (HF) with not fire retardant

Price Category 5	+\$70
Price Category 1	+\$0
Price Category 2	+\$11
Price Category 3	+\$22
Price Category 4	+\$42
Price Category C	+\$44
Price Category E	+\$67
Price Category F	+\$87
Price Category G	+\$113
Price Category I	+\$161

For upholstered cushion seat, upholstered back (UF) with not fire retardant

Price Category D	+\$56
Price Category 1	+\$0
Price Category 2	+\$11
Price Category 3	+\$22
Price Category E	+\$67
Price Category 4	+\$42
Price Category F	+\$87
Price Category G	+\$113
Price Category H	+\$137
Price Category I	+\$161
Price Category K	+\$209
Price Category L	+\$233
Price Category M	+\$257

Step 15. Fabric Back

For upholstered cushion seat, upholstered back (UF) or upholstered cushion seat with protective edge, upholstered back (HF) with not fire retardant

See application chart and textiles list for fabric usage and numbers. First 2 digits of number indicate fabric line; remaining digit(s) indicate fabric color.

Price Category D	+\$0
Price Category 4	+\$42
Price Category 1	+\$0
Price Category 2	+\$11
Price Category E	+\$69
Price Category F	+\$89
Price Category I	+\$164



Celle® Stools

Product Information

Description

This stool has a Cellular Suspension™ back material that is breathable and allows the back to provide flexible and continuous support. The Harmonic™ tilt provides continuous balance and lets the body recline naturally, pivoting at the ankles, knees, and hips. The stool has a 5-star base and a 20"-diameter height-adjustable foot rest. It has a seat height adjustment range of 23 1/2" to 33 1/2". Ships fully assembled.

Tilt options include a tilt limiter, and tilt limiter and seat angle. The tilt limiter allows the user to set the tilt range to limit the amount of recline and set the back into an upright position. The tilt limiter and seat angle allows the user to select the tilt range and either a horizontal or 5° forward seat angle.

Back options include a standard version and a user-adjustable lumbar support version. The adjustable lumbar support adjusts 4" in height and 1" in depth. Both back options include passive PostureFit® at the base of the back, below the beltline, that helps achieve healthier posture and improved lower back comfort.

Upholstered options include an upholstered contoured foam cushion seat with a Cellular Suspension back or upholstered back.

Seat options include a 15 1/2" fixed seat depth or an adjustable seat depth that adjusts from 15 1/2" to 18". Seat options include Cellular Suspension or upholstered seat cushion.

Arm choices include no arms, fixed arms, or 3-dimensional adjustable arms. Each arm adjusts 4" vertically and 1" horizontally. Armpads pivot 11° outward and 11° inward.

This product meets TB 117-2013.

A vinyl protective edge can be applied to upholstered seat cushions to minimize the effects of contact between the stool and furniture with sharp edges in small work stations.

Notes

Stool is tested and warranted for use by persons 350 pounds and under.

Foot rest finish is trivalent chrome; column and support ring are black.

Protective edge recommended for healthcare applications.

For information on casters and glides, see Casters and Glides in Appendices.

Customer's Own Material (COM)/Customer's Own Leather (COL) for upholstered cushion seat requires the following:

Seat option—COM—COL

UC—.81 yards—6 square feet

See Order Information in Appendices.

Dimensions

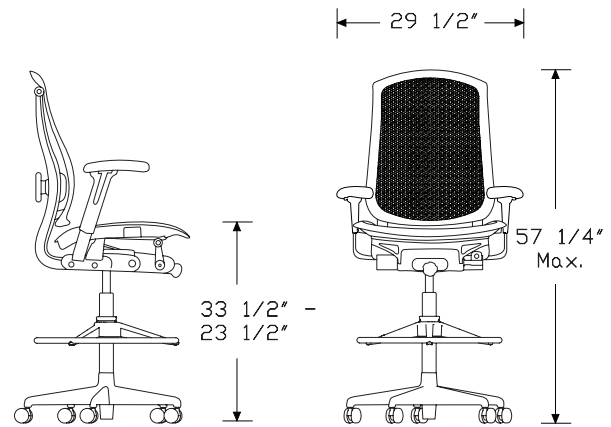

Specification Information		
Step 1.		
CJ7		
Step 2. Height Adjustment		
5	stool extended height range	+\$1041
Step 3. Tilt		
2	tilt limiter	+\$0
3	tilt limiter and seat angle	+\$44
Step 4. Arms		
N	no arms	+\$0
P	fixed arms	+\$100
A	adjustable arms	+\$165
Step 5. Seat-Depth Adjustment		
F	fixed seat depth	+\$0
A	adjustable seat depth	+\$80
Step 6. Seat/Back Material		
CC	Cellular Suspension™ seat and back	+\$0
UC	upholstered cushion seat, Cellular Suspension™ back	+\$43
HC	upholstered cushion seat with protective edge, Cellular Suspension™ back A	+\$69
UF	upholstered cushion seat, upholstered back	+\$133
HF	upholstered cushion seat with protective edge, upholstered back A	+\$152
Step 7. Fire Retardancy		
<i>For not fire retardant (*), skip this step.</i>		
	not fire retardant	+\$0
Step 8. Back Support Option		
N2	no additional support	+\$0
AJ	adjustable lumbar support	+\$50
Step 9. Base/Frame Finish		
3G	brownstone	+\$0
G1	graphite	+\$0
Step 10. Casters/Glides		
BB	2½" hard caster, black yoke, carpet only	+\$0
GF	2½" glide, hard floors or carpet	+\$25
C7	2½" caster, black yoke, hard floors or carpet	+\$50
C9	2½" braking caster, black yoke, hard floors or carpet	+\$50

Step 11. Seat Finish		
<i>For Cellular Suspension™ seat and back (CC) with not fire retardant</i>		
G1	graphite	+\$0
Step 12. Back Finish		
G1	graphite	+\$0
Step 13. Armpad Finish		
<i>For fixed arms (P) or adjustable arms (A)</i>		
3G	brownstone	+\$0
BK	black	+\$0
Step 14. Fabric Seat		
<i>See application chart and textiles list for fabric usage and numbers. First 2 digits of number indicate fabric line; remaining digit(s) indicate fabric color.</i>		
<i>For upholstered cushion seat, Cellular Suspension™ back (UC) with not fire retardant</i>		
	Price Category 1	+\$0
	Price Category 2	+\$11
	Price Category 4	+\$42
	Price Category 5	+\$70
	Price Category 7 A	+\$132
	Price Category 9	+\$218
	Price Category B	+\$32
	Price Category C	+\$44
	Price Category E	+\$67
	Price Category F	+\$87
	Price Category G	+\$113
	Price Category H	+\$137
	Price Category I	+\$161
	Price Category J	+\$185
<i>For upholstered cushion seat with protective edge, Cellular Suspension™ back (HC) with not fire retardant</i>		
	Price Category 1	+\$0
	Price Category 2	+\$11
	Price Category 4	+\$42
	Price Category 5	+\$70
	Price Category B	+\$32
	Price Category C	+\$44
	Price Category E	+\$67
	Price Category F	+\$87
	Price Category G	+\$113
	Price Category H	+\$137
	Price Category I	+\$161

For upholstered cushion seat with protective edge, upholstered back (HF) with not fire retardant

Price Category C	+\$44
Price Category 5	+\$70
Price Category 1	+\$0
Price Category 2	+\$11
Price Category 3	+\$22
Price Category 4	+\$42
Price Category E	+\$67
Price Category F	+\$87
Price Category G	+\$113
Price Category I	+\$161

For upholstered cushion seat, upholstered back (UF) with not fire retardant

Price Category 1	+\$0
Price Category 2	+\$11
Price Category 4	+\$42
Price Category E	+\$67
Price Category F	+\$87
Price Category G	+\$113
Price Category H	+\$137
Price Category I	+\$161

Step 15. Fabric Back

For upholstered cushion seat, upholstered back (UF) or upholstered cushion seat with protective edge, upholstered back (HF) with not fire retardant

See application chart and textiles list for fabric usage and numbers. First 2 digits of number indicate fabric line; remaining digit(s) indicate fabric color.

Price Category C	+\$51
Price Category 4	+\$42
Price Category 1	+\$0
Price Category 2	+\$11
Price Category E	+\$69
Price Category F	+\$89
Price Category G	+\$115
Price Category H	+\$140
Price Category I	+\$164

Arm Kit

CJ900

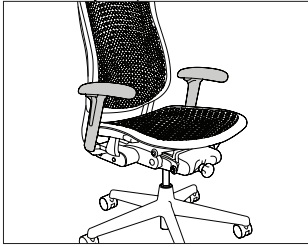

Product Information

Description

These arms retrofit to a Celler® work chair or stool. They adjust 4" vertically, 1" horizontally, and pivot the armpads 11° outward and 11° inward.

Specification Information

Step 1.

CJ900A \$178

Step 2. Frame Finish

3G brownstone +\$0

G1 graphite +\$0

Step 3. Armpad Finish

3G brownstone +\$0

BK black +\$0

Celler® Accessories

20-Day or Less/Assigned Lead-Time Order Information

20-Day or Less and Assigned Lead-Time Programs

20-day or less and assigned lead-time products are designed for established Herman Miller dealers with pre-approved credit.

Products are distributed from multiple manufacturing facilities across the United States. All products and options not designated by an Assigned Lead-Time icon **A** will ship in 20 business days or less after being acknowledged by Herman Miller. Products and options designated by an **A** are on the assigned lead-time program and will ship in 20 days, less than 20 days, or more than 20 days from order acknowledgement.

Ordering Procedure

Please place orders through Order Manager. If this is not available to you, place orders through mail or fax. Verbal purchase orders will not be accepted.

Order Entry fax number for Passage®, 5000 Series, and Meridian® Filing and Storage: (616) 846 9236.

Order Entry fax number for all other products:
(616) 654 3085.

For more information, contact your Customer Care representative at:
(866) 854 3048 EXT 3400.

Shipments and Delivery

Per Herman Miller Terms and Conditions.

Changes and Cancellation

Per Herman Miller Terms and Conditions.



Casters and Glides

▲	WARNING	▲
Depending on the floor surface, chair may unexpectedly roll away from user when entering or exiting the chair, possibly leading to unexpected injury. Please refer to descriptions of floor types when selecting casters.		

32 Caster

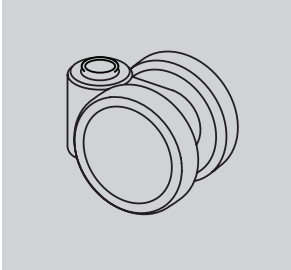

17/8-inch-diameter hard double-wheel caster; black nylon wheels and yoke; for use on carpet only

Applicable on:
Keyn Chairs
Sayl® Chairs

BB Caster

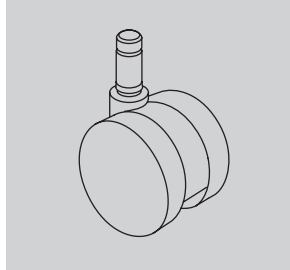

2 1/2-inch-diameter hard double-wheel caster; black nylon wheels and yoke; for use on carpet only

Applicable on:
New Aeron® Chairs
Caper® Chairs
Celle® Chairs
Embody® Chairs
Equa 2® Chairs
Ergon 3® Chairs
Lino™ Chairs Sayl Chairs
Mirra 2 Chairs Verus™ Chairs

BSC Caster

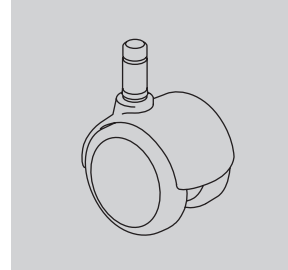

2-inch-diameter double-wheel caster; black nylon wheels and hood; soft polyurethane tread; for use on hard floors or carpet

Applicable on:
Eames® Aluminum Group
Eames Executive Chairs
Eames Soft Pad Group
Eames Task Chairs

C9 Caster

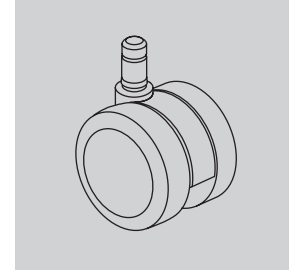

2 1/2-inch-diameter double-wheel caster; black nylon wheels and yoke; soft polyurethane tread; internal brake; for use on hard floors or carpet

Applicable on:
Caper Chairs
Celle Chairs
Embody Chairs
Equa 2 Chairs
Ergon 3 Chairs
Keyn Chairs Sayl Chairs
Lino Chairs Setu® Chairs
Mirra 2 Chairs Verus Chairs

49 Caster

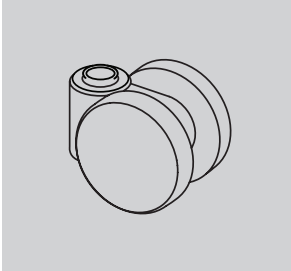

17/8-inch-diameter soft double-wheel caster; black nylon wheels and yoke; for use on hard floors or carpet

Applicable on:
Keyn Chairs
Sayl Chairs

BKS Caster

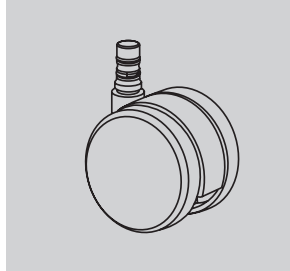

2 1/2-inch-diameter hard double-wheel caster; black yoke; quiet roll technology; for use on carpet only

Applicable on:
Cosm™ Chairs

C7 Caster

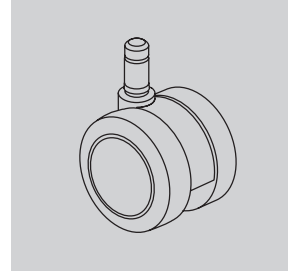

2 1/2-inch-diameter double-wheel caster; black nylon wheels and yoke; soft polyurethane tread; for use on hard floors or carpet

Applicable on:
New Aeron Chairs
Caper Chairs
Celle Chairs
Embody Chairs
Equa 2 Chairs
Ergon 3 Chairs
Lino Chairs
Mirra 2 Chairs
Sayl Chairs Verus Chairs

CA Caster



2-inch-diameter single-wheel caster; black rubber wheel with black yoke; for use on hard floors or carpet

Applicable on:
Co/Struc® System

Casters and Glides

continued

Appendix: Casters and Glides

DC1 Caster

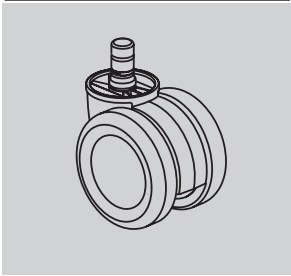

2 1/2-inch-diameter double-wheel braking caster; black nylon wheels and yoke; for use on hard floors or carpet; quiet roll technology

Applicable on:

New Aeron Chairs

H9 Caster

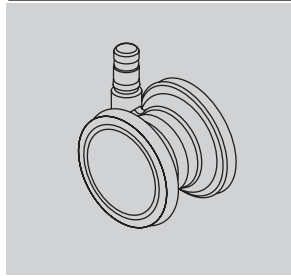

2 1/2-inch-diameter double-wheel caster; clear polycarbonate wheels; nylon yoke; soft polyurethane tread; for use on carpet only.

Applicable on:

Embody Chairs
Keyn Chairs

HW Caster

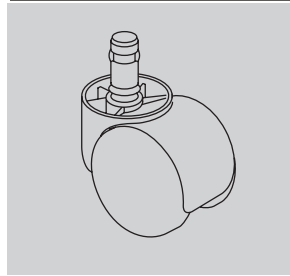

2-inch-diameter double-wheel caster; black nylon wheels and hood; for use on carpet only

Applicable on:

Limerick® Cart

O2 Caster

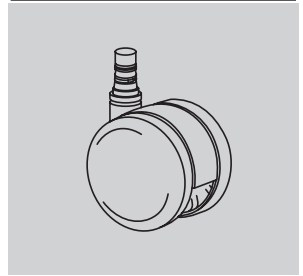

2 1/2-inch-diameter double-wheel caster; nylon wheels and yoke; soft polyurethane tread; quiet roll technology; for use on hard floors or carpet

Applicable on:

Cosm Chairs

DS Caster

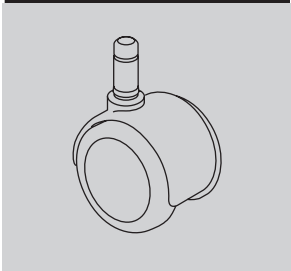

2-inch-diameter soft double-wheel braking caster; black nylon wheels and hood; for use on hard floors only

Applicable on:

Aside® Chairs
Caper Chairs

HCC Caster

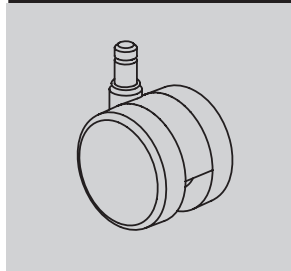

2 1/2-inch-diameter double-wheel low roll resistance caster; black yoke; for use on hard floors or carpet.

Applicable on:

Keyn Chairs
Setu Chairs

MD Caster

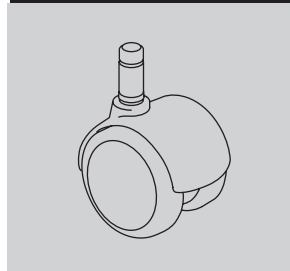

2-inch-diameter double-wheel caster; black nylon wheels with integral chrome hood; soft polyurethane tread; for use on hard floors or carpet

Applicable on:

Eames® Aluminum Group
Eames Executive Chairs
Eames Soft Pad Group
Eames Task Chairs

OC Caster

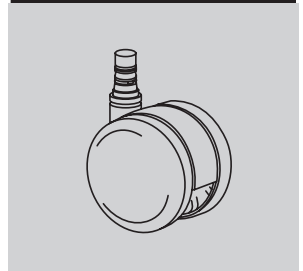

2 1/2-inch-diameter double-wheel medium roll-resistant caster; black nylon wheels and yoke; soft polyurethane tread; for use on hard floors or carpet; quiet roll technology

Applicable on:

Cosm Chairs
Keyn Chairs
Setu Chairs

Casters and Glides

continued

SC8 Caster



2 1/2-inch-diameter double-wheel caster; black nylon wheels and yoke; soft polyurethane tread; quiet roll technology; for use on hard floors or carpet

Applicable on:
Cosm Chairs
Mirra 2 Chairs

U4 Caster

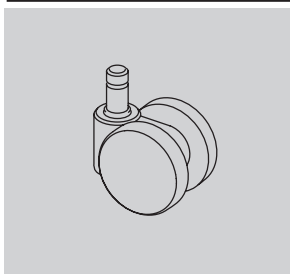

1 7/8-inch-diameter hard double-wheel caster; black nylon wheels and yoke; for use on carpet only

Applicable on:
Aside Chairs
Caper Chairs
Verus Chairs

UD Caster

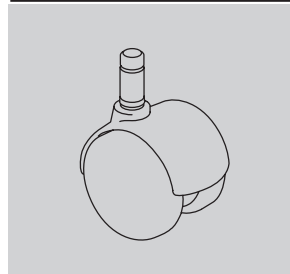

2-inch-diameter hard double-wheel caster; black nylon wheels with painted hood; for use on carpet only

Applicable on:
Eames® Aluminum Group
Eames Executive Chairs
Eames Soft Pad Group
Eames Task Chairs

16 Glide

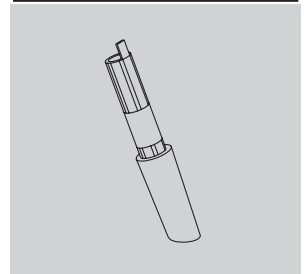

(Front glide shown)
2 1/8-inch-high glide; black or fog acetal; for use on carpet only

Applicable on:
Sayl Chairs

SW Caster

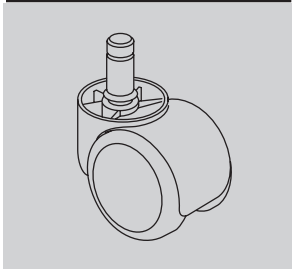

2-inch-diameter soft double-wheel caster; black nylon wheels and hood; for use on hard floors only

Applicable on:
Limerick Cart

U5 Caster

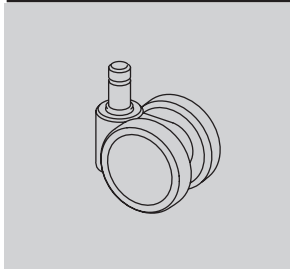

1 7/8-inch-diameter soft double-wheel caster; black nylon wheels and yoke; for use on hard floors or carpet

Applicable on:
Aside Chairs
Caper Chairs
Verus Chairs

VD Caster

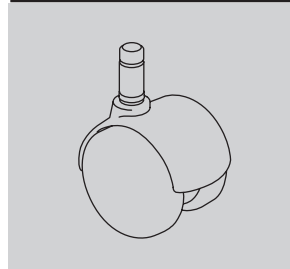

2-inch-diameter hard double-wheel caster; black nylon wheels with integral chrome hood; for use on carpet only

Applicable on:
Eames Aluminum Group
Eames Executive Chairs
Eames Soft Pad Group
Eames Task Chairs

69 Glide

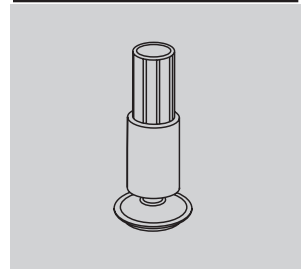

(Front glide shown)
2 1/8-inch-high glide; black glass-filled nylon stem; steel-plated swivel foot with Floor Saver Glide™ insert; for use on hard floors only

Applicable on:
Sayl Chairs

Casters and Glides

continued

Appendix: Casters and Glides

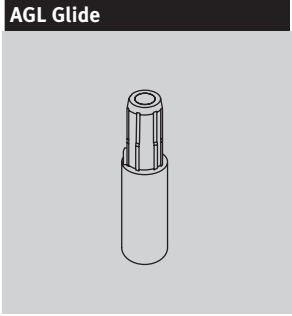

AGL Glide
 2¹/₄-inch-high glide; black or white nylon stem; for use on carpet only
 Applicable on:
 Keyn Chairs

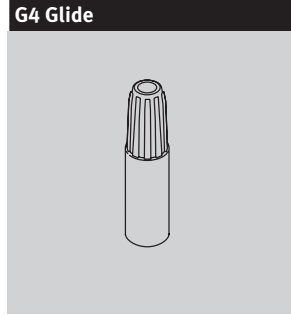

G4 Glide
 1⁷/₈-inch-high glide; black acetal; for use on carpet only
 Applicable on:
 Verus Chairs



GF Glide
 2¹/₂-inch-high glide; black nylon; for use on hard floors or carpet
 Applicable on:
 New Aeron Chairs
 Caper Chairs
 Celle Chairs
 Cosm Chairs
 Equa 2 Chairs
 Ergon 3 Chairs
 Lino Chairs
 Mirra 2 Chairs
 Sayl Chairs
 Verus Chairs

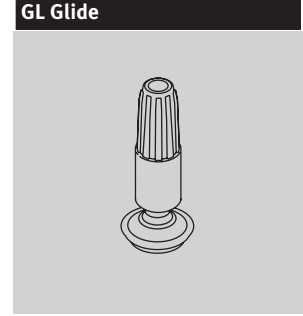

GL Glide
 1⁷/₈-inch-high glide; black nylon stem; steel-plated swivel foot with Floor Saver Glide™ insert; for use on hard floors only
 Applicable on:
 Verus chairs



FSG Glide
 2¹/₄-inch-high glide; black or white nylon stem; steel-plated swivel foot with Floor Saver Glide™ insert; for use on hard floors only
 Applicable on:
 Keyn Chairs



GD Glide
 1¹/₂-inch-diameter glide; 1/2 inch in height; black nylon; for use on hard floors or carpet
 Applicable on:
 Eames Aluminum Group
 Eames Executive Chairs
 Eames Soft Pad Group
 Eames Task Chairs



GG Glide
 1/2-inch-high ganging glide; clear polycarbonate; for use on hard floors or carpet
 Applicable on:
 Limerick Chairs



HG Glide
 1/2-inch-high glide; black nylon glide with stainless-steel insert; for use on hard floors or carpet
 Applicable on:
 Aside Chairs

Casters and Glides

continued

SB Glide



1/4-inch-high, 1-inch diameter glide; thermoplastic CAP material (G1 base has black glides; XT base has clear glides); for use on hard floors or carpet

Applicable on:

Equa 2 Chairs

SG Glide (for Limerick)

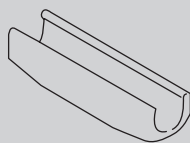

1/2-inch-high glide; clear polycarbonate; for use on hard floors or carpet

Applicable on:

Limerick Chairs

XS Glide

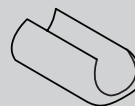

1/8-inch-high glide; polycarbonate in black, fog, clear, and studio white finishes; for use on hard floors or carpet

Applicable on:

Sayl Chairs

YX Glide



1 7/8-inch-high glide; black nylon stem; steel-plated swivel foot with Floor Saver Glide™ insert; for use on hard floors only

Applicable on:

Caper Chairs

SG Glide (for Aside)



1/2-inch-high glide; black nylon; for use on carpet only

Applicable on:

Aside Chairs

X8 Glide

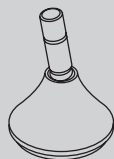

Glide; low profile; for use on hard floors or carpet

Applicable on:

Setu Chairs

Y7 Glide



1 7/8-inch-high glide; black acetal; for use on carpet only

Applicable on:

Caper Chairs



Fire Retardancy — Seating

Fire Retardancy

Fire-retardant chairs manufactured in approved fabrics (FR) meet California TB 133 requirements.

All foam and textiles on HermanMiller seating products comply with California TB 117-2013.

State of California
Bureau of Home Furnishings,
Technical Bulletin 133

State of California
Bureau of Home Furnishings,
Technical Bulletin 117-2013

8Z Pellicle		•
Ace		•
AireWeave™ 2		•
Aristo		•
Balance		•
Bento		•
Bingo		•
Crepe		•
Crossing		•
Cygnus™	FR	•
Dex		•
Dialogue		•
Duo		•
Epic		•
Fish Net		•
Flexnet™	FR	•
Gem		•
Hopsak		•
Intercept		•
InterWeave		•
Latitude™		•
Leather		•
Loom		•
Lyris 2™		•
Marvel		•
Medley		•
Mercer		•
Moiré		•
Monologue		•
Noble		•
Pins and Needles		•
Plateau		•
Quilty		•
Rhythm		•
Rivet		•
Sequel		•
Spools		•
Stitches		•
Strata		•
String Plaid		•
Tailored		•
Twist		•
Well Suited		•
Whisper		•

• Fabric meets California TB 117-2013 code requirements.

FR To meet California TB 133 code requirements, fabrics must be applied to approved chairs identified with FR product numbers.



Customer's Own Material/Customer's Own Leather Order Information — Seating

Packaging

Packaging varies according to individual product. A surcharge may be added for special packaging requests. Contact Customer Care for specific information.

Customer's Own Material/Customer's Own Leather

Program Overview

The Customer's Own Material (COM) and Customer's Own Leather (COL) program gives you the option of using textiles other than those listed. Herman Miller will test textiles for application to Herman Miller products and will process orders for those with approved COM/COL textiles only. COM/COL are assigned lead-time textiles.

Omni lists an overview of fabrics and leathers that have been tested and indicates whether or not they were approved for application to Herman Miller products.

Specific information on the terms and conditions, testing, approval, and ordering process for COM/COL is listed below. Questions about the COM/COL program and requests for assistance may be directed to your COM representative at:

(616) 654 3400

(866) 854 3048 EXT 6543400

Customer's Own Material/Customer's Own Leather Warranty

Herman Miller does not warrant COM/COL textiles. COM/COL textiles are tested for application only; they are not tested for performance. The Herman Miller warranty does apply to the underlying products.

Suppliers of COM/COL textiles are responsible for color consistency within commercial tolerances, UV stability, and resistance to soiling and perspiration.

Customer's Own Material/Customer's Own Leather Pricing

COM is a Category 1 fabric. There are no application charges for COM fabrics. COL is a Category 7 textile; refer to prices on specific products to determine the application charge.

Ordering and payment for COM/COL textile yardage are the responsibility of the customer and the textile supplier.

If desired, Herman Miller will purchase COM textiles directly from Maharam, Camira, C.F. Stinson, Guilford of Maine, Luna Textiles, Momentum Textiles and Ultrafabrics to simplify ordering and shipment. For this service, refer to the Supplier Connection program.

Textile Approval

1. Select a COM textile and a Herman Miller product.
2. If your textile does not show as tested in Omni, submit a request. You will be required to select a specific color of the textile and feature of the product to test, i.e., seat, back, etc.
3. Herman Miller will notify you of approval or disapproval within 4 days from receipt of the test yardage.

Ordering Products with COM/COL

1. Refer to the specific products to determine the yardage required for COM/COL textiles.
Note: Additional yardage may be needed due to the unique characteristics of a textile.
2. Obtain the COM ID# in Omni. If the color you are ordering does not have a COM ID# assigned, click "Create ID".
3. Enter your order on Order Manager in Omni.
4. Upon receipt of your purchase order, Herman Miller will send you a PO acknowledgment.
5. Arrangements must be made for the textiles to be shipped from the supplier to Herman Miller for application to the seating products. Textiles must be tagged with the assigned identification number and the roll yardage quantity. See Omni for shipping procedures and current shipping addresses or contact a COM representative at (616) 654 3400 or (866) 854 3048 EXT 6543400.

Products will be scheduled for production when COM/COL textiles are received at Herman Miller. Standard lead times in effect at that time will apply.

Note: If textiles are to be purchased directly by Herman Miller through the Supplier Connection program, Herman Miller will handle the ordering and shipping process and will schedule your order for production upon receipt of your purchase order (dependent on textile availability). Refer to the Supplier Connection program for more information.

Customer's Own Material/Customer's Own Leather Order Information — Seating

continued

Supplier Connection

Program Overview

The Supplier Connection program is a service offered by Herman Miller to purchase approved COM textiles directly from Maharam, Camira, C.F. Stinson, Guilford of Maine, Luna Textiles, Momentum Textiles and Ultrafabrics. When you select a textile through this program, Herman Miller will facilitate the ordering, scheduling, and shipment of the textile directly with the supplier.

Suppliers included in the Supplier Connection program keep an active inventory of textiles that are pre-approved for application to Herman Miller products. Pre-approval applies only to the suitability of a textile for manufacturing and application to a Herman Miller product. Omni provides an overview of fabrics that have been tested and indicates whether or not they were approved for application to Herman Miller products.

Specific information on the terms and conditions, testing, approval, and ordering process for the Supplier Connection program is listed below. Questions and requests for assistance may be directed to your COM representative at:

(616) 654 3400

(866) 854 3048 EXT 6543400

Supplier Connection Warranty

Textiles purchased by Herman Miller through the Supplier Connection program are COM and are not warranted by Herman Miller. COM textiles are tested for application only; they are not tested for performance. The Herman Miller warranty does apply to the underlying products.

Suppliers of COM textiles are responsible for color consistency within commercial tolerances, UV stability, and resistance to soiling and perspiration.

Supplier Connection Pricing

Textiles purchased by Herman Miller through the Supplier Connection program are COM. COM is a Category 1 fabric. There are no application charges for COM fabrics.

Payment for textiles purchased by Herman Miller through the Supplier Connection program is the responsibility of the customer or dealer. Herman Miller will invoice the order at a total product cost based on the supplier's price published at the time of the order.

Textile Approval

1. Select a COM textile and a Herman Miller product.
2. If your textile does not show as tested in Omni, submit a request. You will be required to select a specific color of the textile and feature of the product to test, i.e., seat, back, etc.
3. Herman Miller will notify you of approval or disapproval within 4 days from receipt of the test yardage.

Ordering Products with Supplier Connection COM

1. Identify and include the following information on your purchase order:
 - Product number and option
 - Herman Miller's COM identification number
2. Enter your order on Order Manager in Omni.
3. Upon receipt of the purchase order, Herman Miller will process your order and send you a PO acknowledgment. Herman Miller will determine the yardage required to produce your product and will order and schedule for delivery the required textile. Standard lead times in effect at the time the textile is allocated at the supplier will apply to products ordered through this program.

Proprietary Textiles Application Chart — Seating

• Available

[A] Assigned lead-time textile.

[N] Non-woven textile.

See following page for exception notes.

	Aeron® Chairs	Cosm™ Chairs	Mirra® 2 Chairs/Stools	Celle® Chairs/Stools	Embody® Chairs	Sayl® Work Chairs/Stools	Sayl Side Chairs	Setu® Chairs/Stools	Setu Lounge Chair/Ottoman	Verus™ Work Chairs/Stools Back	Verus Work Chairs/Stools Seat	Verus Side Chairs Back	Verus Side Chairs Seat	Verus Plus Chairs	Aside® Chairs	Caper® Chairs/Stools	Keyn Chair Group Back	Keyn Chair Group Seat	Lino™ Chairs Back	Lino Chairs Seat	Locale® Bench Cushion	Public Office Landscape® Back	Public Office Landscape Seat	Plex® Lounge Furniture	Swoop™ Lounge Seating - Fully Upholstered	Swoop Lounge Seating - Plywood	Valor™ Seating	Eames® Tandem Sling Seating	Cushion Tops	Workspaces	
Price Category 1																															
COM Customer's Own Material [A]			14			1	1			1	1	1	1	1	1			1		1	1				1	1	1		1	1	1
231__ 8Z Pellicle®	•																														
1A7__ AireWeave™ 2			•																												
8T__ Crossing			•					•	•						•						•				•	•				•	•
3DE__ Dex			14			•	•	•		•	•	•	•	•	•			•				•		19	•					•	•
4RM__ Duo																			•												
6V__ Flexnet™																•															
95__ Gem			14					•	•						•							•			•	•				•	•
845__ Intercept		•																													
365__ Interweave 2										•		•																			
4W__ Lyris 2™								•	•																						
1MN__ Monologue			14			24	22	•	•	•	•	•	•				•	•			•	•		•	•	•	•		•	•	
3DK__ Stretch Knit [A]						21																									
235__ Tailored [A]			•			•	•	•	•	•	•	•	•		•									•	23					7	•
1WS__ Whisper			14			24	•	•	•	•	•	•	•	•	•																
Price Category 2																															
3AR__ Aristo			14			•	•	•	•	•	•	•	•	•	•			•			•	•		•	•	•	•			•	•
92__ Crepe			•			•	•	•	•	•	•	•	•	•	•			•	•		•	•		•	•	•	•			•	•
3EP__ Epic			14			•	•	•		•	•	•	•	•	•			•	•					•	•	•	•			7	•
22Q__ Fish Net			•			•	•	•		•	•	•	•	•	•			•	•					•	•				7	•	
1LM__ Loom			14			•	•			•	•	•	•	•				•	•							•	20			•	•
1MV__ Marvel [N]						21	22											•												•	
1HA__ Medley			15			•	•	22		•	•	•	•	•	•			•	•			•	•		•	•	•		•	•	•
30__ Rhythm			•	23		•	•			•	•	•	•	•	•			•	•			•	•		•	•	•			•	•
1RV__ Rivet			14			21	22			•	•	•	•	•	•			•	•			•	•		•	•	•			•	•
3SL__ Sequel [N] [A]			15			•	•	•	•	•	•	•	•	•	8			•	•			•	•		•	•	•		•	•	•
8R__ Twist			•			•	•	•	•	•	•	•	•	•	•			•	•			•	•		•	•	•			•	•
22T__ Well Suited															8										•	23				•	
Price Category 3																															
3AC__ Ace [N]						21	•			•	•	•	•	•	8			•	•			•	•		19					•	
70__ Bento						•	•	•	•		•	•	•		8			•													•
4LN__ Landing																														•	
8M__ Latitude™				23		•	•																		•	•					
22V__ String Plaid			14			•	•			•	•	•	•	•	•			•				•	•		•	•	•			•	•
Price Category 4																															
1DL__ Dialogue																							•								
213__ Mercer			14			21	22			•	•	•	•	•				•	•				•		•	•				•	
1A9__ Network																							•								
6S__ Quilty			14			•	•			•	•	•	•		•			•	•			•	•		•	•				•	•
22P__ Strata						•	•	•		•	•	•	•	•	•			•	•			•	•		•	•	•			•	•
3SY__ Sync			•	•		•	•	•	•	•	•	•	•	•	•			•	•			•	•		•	•	•			•	•

continued on next page

Proprietary Textiles Application Chart — Seating continued

• Available

[A] Assigned lead-time textile.

[N] Non-woven textile.

See below for exception notes.

	Aeron® Chairs	Cosm™ Chairs	Mirra® 2 Chairs/Stools	Celle® Chairs/Stools	Embody® Chairs	Sayl® Work Chairs/Stools	Sayl Side Chairs	Setu® Chairs/Stools	Setu Lounge Chair/Ottoman	Verus™ Work Chairs/Stools Back	Verus Work Chairs/Stools Seat	Verus Side Chairs Back	Verus Side Chairs Seat	Verus Plus Chairs	Aside® Chairs	Caper® Chairs/Stools	Keyn Chair Group Back	Keyn Chair Group Seat	Lino™ Chairs Back	Lino Chairs Seat	Locale® Bench Cushion	Public Office Landscape® Back	Public Office Landscape Seat	Plex® Lounge Furniture	Swoop™ Lounge Seating - Fully Upholstered	Swoop Lounge Seating - Plywood	Valor™ Seating	Eames® Tandem Sling Seating	Cushion Tops	Workspaces			
Price Category 5																																	
14A__ Hopsak			14		•	•	•	•	•	•	•	•	•	•	•		•	•		•	•			•	•	•	•	•	•	•	•	•	•
22N__ Noble (22H__)			14		•	25	•			•	•	•	•	•	8		•	•		•	•			•	•	•	•	•	•	•	•	•	
3SU__ Summit [N]			15		•	•				•	•	•	•	•						•	•			•	•	•	•	•	•	•	•	•	
Price Category 6																																	
35__ Balance					•																												
Price Category 7																																	
COL Customer's Own Leather [A]	1		14												8																	1	
Price Category 8																																	
No fabrics available at this time																																	
Price Category 9																																	
21__ Leather [N]	23		14											8						•						•					•		

Application Note: Herman Miller cannot guarantee material/pattern alignment in adjacent products. For example, a fabric's pattern may not align from one pedestal cushion top to the next, or from one chair to another.

- 1 Refer to price book appendices and Omni for COM/COL information.
- 7 Available on 1" Cushion Tops only.
- 8 Only available on the Aside nonupholstered outer back option (PB).
- 14 Available on Celle UC (upholstered seat) and Celle UF (upholstered seat) Chairs.
- 15 Available only on Celle HC (upholstered seat with protective edge) and Celle HF (upholstered seat) Chairs.
- 19 Available on Plex seat only.
- 20 Available in select colors. Refer to "Proprietary Textile Colors - Seating" for color offering.
- 21 Not available on Sayl upholstered back work chairs.
- 22 Not available on Sayl side chairs with upholstered backs.
- 23 Available in select colors. Refer to "Proprietary Textile Colors-Seating" for color offering.
- 24 Not available on Sayl upholstered High-Back Work Chairs.
- 25 Not available on Sayl side chairs with upholstered backs. Available in select colors. Refer to "Proprietary Textile Colors-Seating" for color offering.

Proprietary Textile Colors — Seating

Price Category 1

Customer's Own Material
See Order Information in
Appendices.
Assigned lead-time textile. A

8Z Pellicle®
For New Aeron® Chairs
56% elastomeric
44% polyester
23101 Mineral
23102 Carbon
23103 Graphite

AireWeave™ 2
For Mirra® 2 Chairs
67% elastomeric
33% antimony-free polyester
1A701 Alpine
1A702 Slate Grey
1A703 Graphite
1A704 Lime Green
1A705 Cappuccino
1A706 Urban Orange
1A707 Dark Turquoise
1A708 Twilight

Crossing
54" wide
86% antimony-free polyester
14% polyester
8T03 Wicker
8T04 Porcelain
8T05 Warm Grey
8T06 Sepia
8T07 Pumpkin
8T08 Copper
8T09 Cranberry
8T10 Tomato
8T11 Mulberry
8T12 Plum
8T13 Green Apple
8T14 Loden
8T15 Spruce
8T16 Periwinkle
8T17 Cerulean
8T18 Indigo
8T19 Shale
8T20 Brownstone
8T21 Bark
8T22 Tin
8T23 Graphite
8T24 Black

Dex
54" wide
50% recycled polyester
50% polyester
3DE01 Frost
3DE02 Silver Pine
3DE03 Stone
3DE04 Shale
3DE05 Charcoal

Duo
For Lino™ Chairs
52% polyester
48% elastomeric
4RM01 Mineral
4RM02 Poppy
4RM03 Green Leaf
4RM04 Jade
4RM05 Shadow
4RM06 Graphite

Flexnet™
For Caper® Chairs
69% elastomeric
31% polyester
6V01 Black
6V02 Silver Grey

Gem
54" wide
100% antimony-free polyester
9502 Tangerine
9503 Red
9507 Twilight
9508 Bayou
9510 Berry Blue
9511 Aqua Green
9512 Green Apple
9514 Black
9515 Slate Grey
9516 Fog

Intercept
For Cosm™ Chairs
60% elastomeric
40% polyester
84501 Graphite
84502 Carbon
84503 Mineral
84504 Nightfall
84505 Glacier
84506 Canyon

Interweave 2
For Verus™ Chairs
65% elastomeric
35% polyester
36501 Iceberg
36502 Poppy
36503 Beachglass
36504 Blue Grotto
36505 Slate
36506 Shale

Lyris 2™
For Setu® Chairs
74% elastomeric
26% polyester
4W21 Alpine
4W22 Mango
4W23 Chartreuse
4W25 Berry Blue
4W26 Slate Grey
4W28 Chino
4W29 Rattan
4W30 Java
4W31 Graphite

Monologue
54" wide
56% recycled polyester
44% polyester
1MN01 Linen
1MN02 Alabaster
1MN03 Truffle
1MN04 Folkstone
1MN05 Silver Pine
1MN06 Slate
1MN07 Seed
1MN08 Yellow Oxide
1MN09 Persimmon
1MN10 Tundra
1MN11 Meadow
1MN12 Blue Sky
1MN13 Blue Spruce
1MN14 Deep Sea

Stretch Knit
Assigned lead-time textile. A
Available only on Sayl®
Suspension Back Work Chairs
97% polyester, 3% spandex
3DK01 Fog
3DK02 Slate Grey
3DK03 Java
3DK04 Black
3DK05 Red
3DK06 Green Apple
3DK07 Berry Blue

*Price category 1 continued on
next page*

Proprietary Textile Colors — Seating

continued

Price Category 1

continued

Tailored

Assigned lead-time textile. A

54" wide

56% polyester

44% recycled polyester

23501 Studio White *

23502 Sugar *

23503 Tomato

23504 Orchid

23505 Boysenberry

23506 Chive

23507 Bluegrass

23508 Cobalt

23509 Cadet

23510 Fog

23511 Graphite

23512 Black

23513 Coffee

* Colors not available on
Plex™ Lounge Furniture.

Whisper

54" wide

73% recycled polyester

27% polyester

1WS01 Sand Dollar

1WS02 Pebble

1WS03 Silver Birch

1WS04 Iceberg

1WS05 Silver Pine

1WS06 Carbon

1WS07 Cumin

1WS08 Adobe

1WS09 Strawberry

1WS10 Blush

1WS11 Eggplant

1WS12 Willow

1WS13 Sea Grass

1WS14 Pool

1WS15 Blueberry

Price Category 2

Aristo

54" wide

88% recycled polyester

12% polyester

Acrylic backing

3AR01 Forest Moss

3AR02 Light Brindle

3AR03 Mink

3AR04 Copper

3AR05 Adobe

3AR06 Cherry

3AR07 Lilac

3AR08 Green Apple

3AR09 Surf

3AR10 Waterfall

3AR11 Cadet

3AR12 Tin

3AR13 Pewter

3AR14 Grey Brindle

3AR15 Grey Black

Crepe

54" wide

100% recycled polyester

9201 Licorice

9203 Smoke

9207 Cherry

9209 Claret

9212 Raisin

9218 Aquamarine

9223 Cadet

9241 Beachglass

9243 Midnight

9244 Artichoke

9248 Warm White

9249 Stone

9250 Earth

9251 Fog

9252 Slate Grey

9253 Yellow Dark

9254 Coral

9255 Blush Grey

9256 Wild Berry

9257 Clover

9258 Caribbean

9259 Cerulean

Crepe continued

9260 Brownstone

9261 Shale

9262 Graphite

9263 Tomato

9264 Green Apple

Epic

54" wide

56% recycled polyester

44% polyester

Acrylic backing

3EP01 Alabaster

3EP02 Smoke

3EP03 Falcon

3EP04 Citrus Spring

3EP05 Copper

3EP06 Urban Orange

3EP07 Poppy

3EP08 Wild Plum

3EP09 Sugar Plum

3EP10 Clover

3EP11 Loden

3EP12 Everglade

3EP13 Mist

3EP14 Peacock

3EP15 Cadet

3EP16 Indigo

3EP17 Spring Wood

3EP18 Grey Brindle

3EP19 Seed

3EP20 Carbon Dark

Fish Net

55" wide

100% recycled polyester

22Q01 Oyster

22Q02 Stone

22Q03 Citrus

22Q04 Curry

22Q05 Chipotle

22Q06 Cherry

22Q07 Fuschia

22Q08 Claret

22Q09 Purple

22Q10 Clover

22Q11 Pesto

22Q12 Peacock

22Q13 Lagoon

22Q14 Twilight

22Q15 Bluestone

22Q16 Storm

22Q17 Black

22Q18 Cocoa

Loom

54" wide

100% polyester

1LM01 Linen *

1LM02 Brown Sugar and Spice

1LM03 Brick and Mortar

1LM04 Salt and Pepper

1LM05 Black

1LM06 Lemongrass

1LM07 Poppy

1LM08 Wild Berry

1LM09 Loden

1LM10 Jade

1LM11 Deep Sea

* Color not available on
Valor™ Seating

Price category 2 continued on
next page

Proprietary Textile Colors — Seating

continued

Price Category 2

continued

Marvel	
54" wide	
100% pvc-free polyurethane	
1MV01	Summer White
1MV02	Sand Dollar
1MV03	Espresso
1MV04	Folkstone Grey
1MV05	Graphite
1MV06	Onyx
1MV07	Polar Blue
1MV08	Blush Grey
1MV09	Woodrose
1MV10	Citrus
1MV11	Adobe
1MV12	Red
1MV13	Kiwi Green
1MV14	Pine
1MV15	Teal Green
1MV16	Twilight

Medley	
54" wide	
100% polyester	
1HA01	Stone
1HA02	Trail
1HA03	Charcoal
1HA04	Cinder
1HA05	Citrus
1HA06	Papaya
1HA07	Chutney
1HA08	Tundra
1HA09	Feather Grey
1HA10	Chartreuse
1HA11	Loden
1HA12	Peacock
1HA13	Bayou
1HA14	Blue Grotto
1HA15	Blueberry
1HA22	Khaki
1HA23	Pewter
1HA24	Yellow Oxide
1HA25	Vintage Rose
1HA26	Raspberry
1HA27	Acai Berry

Rhythm	
54" wide	
100% polyester	
3001	Kiwi Green *
3002	Green Apple
3003	Peacock
3004	Bayou *
3005	Berry Blue
3006	Iris
3007	Twilight
3008	Pumpkin *
3009	Poppy *
3010	Molasses
3011	Mulberry
3012	Khaki *
3013	Mink
3014	Black
3015	Charcoal

* Colors not available on Embody® Chair.

Rivet	
54" wide	
100% recycled polyester	
1RV01	Twig
1RV02	Deep Clay
1RV03	Woodrose
1RV04	Otter
1RV05	Hemlock
1RV06	Olive
1RV07	Lagoon
1RV08	Deep Sea
1RV09	Charcoal
1RV10	Grey Brindle

Sequel	
Assigned lead-time textile. A	
54" wide	
100% vinyl	
100% polyester knit backing	
Resilience® finish	
3SL01	White
3SL02	Pebble
3SL03	Mushroom
3SL04	Stone
3SL05	Chestnut
3SL06	Rattan
3SL07	Black Cherry
3SL08	Tundra
3SL09	Seal
3SL10	Blue Fog
3SL11	Folkstone
3SL12	Shale
3SL13	Slate Grey
3SL14	Charcoal
3SL15	Carbon Dark
3SL28	Navy

Twist	
54" wide	
80% antimony-free polyester	
13% recycled polyester	
7% polyester	
8R05	Wicker
8R10	Poppy
8R14	Tin
8R15	Shale
8R16	Graphite
8R17	Birch
8R18	Sepia
8R22	Blueberry
8R23	Green Apple
8R26	Gunmetal
8R27	Cinder
8R28	Citrus
8R29	Pekoe
8R30	Tangerine
8R31	Red Plum
8R32	Wisteria
8R33	Forest
8R34	Jade Dark
8R35	Waterfall
8R36	Midnight Blue
8R37	Carbon Dark

Well Suited	
55" wide	
79% polyester	
21% recycled polyester	
22T01	Oyster *
22T02	Raffia *
22T03	Peppermint *
22T08	Cool Grey *
22T16	Jade
22T17	Peacock
22T18	Blueberry

* Colors not available on Swoop™ Plywood Lounge Seating.

Proprietary Textile Colors — Seating

continued

Price Category 3

Ace	
54" wide	
100% polyurethane	
Polyester knit backing	
Stain resistant finish	
3AC01	Summer White
3AC02	White Ash
3AC03	Rye
3AC04	Metal
3AC05	Clay
3AC06	Chestnut
3AC07	Citrus
3AC08	Camelback
3AC09	Chipotle
3AC10	Claret
3AC11	Slate Purple
3AC12	Artichoke
3AC13	Sepia Dark
3AC14	Aloe
3AC15	Flint
3AC16	Blue Sky
3AC17	Oceanside
3AC18	Midnight
3AC19	Spring Wood
3AC20	Frost
3AC21	Lead
3AC22	Black

Bento	
54" wide	
100% antimony-free polyester	
7001	Frost
7002	Linen
7003	Khaki
7004	Truffle
7005	Grey Black
7006	Pumpkin
7007	Cranberry
7008	Everglade
7009	Cobalt

Landing	
For Eames® Tandem Sling Seating	
54" wide	
100% TPE	
Polyester knit backing	
4LN01	Black

Latitude™	
61" wide	
100% polyester	
8M01	Graphite
8M02	Shadow
8M10	Alpine
8M17	Black
8M21	Slate Grey
8M22	Lime Green
8M23	French Press
8M24	Urban Orange
8M25	Dark Turquoise
8M26	Twilight

Latitude	
Colors for Mirra 2 Chairs	
100% polyester	
8M10	Alpine
8M17	Black
8M21	Slate Grey
8M22	Lime Green
8M23	French Press
8M24	Urban Orange
8M25	Dark Turquoise
8M26	Twilight

String Plaid	
54" wide	
100% recycled polyester	
22V01	Warm White on Khaki
22V02	Mint on Yellow Green
22V03	Mist on Blue Grey
22V04	Sky Blue on Red
22V05	Lime on Magenta
22V06	Bright Green on Green
22V07	Aqua Blue on Cerulean
22V08	Ivory on Black

Price Category 4

Dialogue	
For Public Office Landscape®	
Sectional Back/Social Chair Back	
knit to size	
100% polyester	
1DL01	Light Brindle
1DL02	Dark Brindle

Mercer	
54" wide	
50% solution dyed recycled nylon	
50% solution dyed nylon	
BLOCKaide	
21301	Stone
21303	Cayenne
21305	Pesto
21306	Teal Blue
21307	Ultramarine
21310	Charcoal

Network	
For Public Office Landscape®	
Sectional Back/Social Chair Back	
knit to size	
100% polyester	
1A901	Warm White
1A902	Fog
1A903	Red
1A904	Wildberry
1A905	Green Apple
1A906	Twilight
1A907	Graphite

Price category 4 continued on next page

Proprietary Textile Colors — Seating

continued

Price Category 4

continued

Quilty	
56" wide	
100% antimony-free polyester	
GreenShield	
6S03	Khaki
6S04	Straw
6S07	Brick
6S10	Mink
6S11	Green Apple
6S13	Indigo
6S14	Zinc
6S15	Slate
6S16	Beachwood
6S17	Paprika
6S18	Plum
6S19	Juniper
6S20	Grey Black

Strata	
54" wide	
50% solution dyed recycled nylon	
50% solution dyed nylon	
BLOCKaide	
22P04	Pesto
22P05	Peacock
22P06	Blue Jay
22P07	Blueberry
22P09	Mango
22P10	Paprika
22P12	Wheat
22P13	Brownstone
22P14	Bayou

Sync	
55" wide	
100% polyester	
3SY01	Pine Cone
3SY02	Citron
3SY03	Canyon
3SY04	Truffle
3SY05	Wild Berry
3SY06	Everglade
3SY07	Glacier
3SY08	Nightfall
3SY09	Dark Mineral
3SY10	Slate Grey
3SY11	Dark Carbon
3SY12	Black

Price Category 5

Hopsak	
56" wide	
100% recycled polyester	
14A20	Black
14A22	Raw Umber Dark
14A26	Grey Blue Dark
14A30	Sepia Dark
14A38	Emerald Dark
14A39	Yellow Dark
14A40	Orange
14A41	Sienna
14A42	Olive Green Dark
14A43	Crimson
14A44	Crimson Dark Dark
14A45	Violet Dark
14A46	Pink Dark Dark
14A47	Ultramarine Dark
14A48	Cobalt Blue
14A49	Terra Cotta
14A50	Ochre Dark

Noble	
Assigned lead-time textile. <input type="checkbox"/>	
54" wide	
100% wool	
22N07	Cadet *
22N12	Blue Grey Mix *
22H15	Heathered Black **
22H16	Heathered Grey **
22H17	Heathered Twilight **
22H18	Heathered Rye Grass **
22N23	Lagoon Mix *

* Colors not available on Sayl® Side Chairs.

** Colors not available on Sayl Side Chairs Back.

Summit	
54" wide	
100% silicone	
Polyester knit backing	
3SU01	Bright White
3SU02	Oyster
3SU03	Metal
3SU04	Khaki
3SU05	Taupe
3SU06	Java
3SU07	Black
3SU08	Cherry
3SU09	Beachglass
3SU10	Midnight

Proprietary Textile Colors — Seating

continued

Appendix: Proprietary Textile Colors | Seating

Price Category 6

Balance	
For Embody® chairs	
100% polyester	
3512	Carbon
3513	Black

Price Category 7

Customer's Own Leather
See Order Information in Appendices. Assigned lead-time textile. A

Price Category 8

No fabrics available at this time.

Price Category 9

Leather	
approx. 50 sq. ft. per hide	
100% leather	
2101	Ivory
2109	Black *
2110	Smoke
2111	Graphite
2112	Khaki
2113	Rattan
2114	Truffle
2115	Alpine
2116	Haze
2117	Sable Grey
2118	Dark Mineral **
2119	Dark Carbon ***
2120	Cranberry
2121	Deep Sea

* Armpad color available on Aeron® Chair, Graphite.

** Armpad color available on Aeron Chair, Mineral.

*** Armpad color available on Aeron Chair, Carbon.

Maharam® Application Chart — Seating

- Available

[A] Maharam textiles are on assigned lead times.

[N] Non-woven textile.

See following page for exception notes.

	Mirra® Chairs/Stools	Celle® Chairs	Sayl® Work Chairs/Stools	Sayl Side Chairs	Setu® Chairs/Stools	Setu Lounge Chair/Ottoman	Verus™ Work Chairs/Stools Back	Verus Work Chairs/Stools Seat	Verus Side Chairs Back	Verus Side Chairs Seat	Verus Plus Chairs	Aside® Chairs	Caper® Chairs/Stools	Keyn Chair Group Back	Keyn Chair Group Seat	Lino™ Chairs Seat	Locale® Bench Cushions	Public Office Landscape® Seat	Plex® Lounge Furniture	Swoop™ Lounge Seating - Fully Upholstered	Swoop Lounge Seating - Plywood	Valor™ Seating	Cushion Tops	Workspaces
Price Category 1-2																								
No fabrics available at this time.																								
Price Category 3																								
ZM2__ Meld - Maharam *	14	•	•	•	•	•	•	•	•	•	8		•	•	•	•	•	•	•	•	•	•	•	•
Price Category 4-9																								
No fabrics available at this time.																								
Price Category A																								
No fabrics available at this time.																								
Price Category B																								
VM__ Medium - Maharam	14	•	•			•	•	•	•	•	•		•	•	•								•	•
TI__ Messenger - Maharam *	14	•	•	•	•	•	•	•	•	•	•		•	•	•				•	•	•	26	•	•
Price Category C																								
ZLR__ Lariat - Maharam [N]	15	•	•			•	•	•	•	•			•	•	•			•	20			•	•	
Z27__ Manner - Maharam	14	•	•			•	•	•	•	•			•	•	•				•	•	•	•	•	•
887__ Merit - Maharam	14	•	•										•	•	•			•	•	•	•	•	•	
Z3__ Metric - Maharam	14	•	•			•	•	•	•	•			•	•	•			•	•	•	•	•	•	•
ZML__ Milestone - Maharam	14	•	•			•	•	•	•	•			•	•	•			•	•	•	•	•	•	•
8EY__ Murmur - Maharam	14	•	16			•	•	•	•	•			•	•	•			•	•	•	•	•	•	7
Price Category D																								
ZMD__ Mode - Maharam	14	18	•			•	•	•	•	•			•	•	•			•	•	•	•	•	•	•
Price Category E																								
ZAT__ Article - Maharam [N]	14	16	16			•	•	•	•	•			•	•	•			•				•	•	7
896__ Dwell - Maharam	14	16	16			•	•	•	•	•			•	•	•			•				•	•	7
ZFS__ Focus - Maharam	14	16	16										•	•	•							26	•	
ZBQ__ Oblique - Maharam			16			•	•	•	•	•			•	•	•					•	•	•	•	
ZP2__ Pick - Maharam		18	•			•	•	•	•	•			•	•	•					•	•	•	•	
ZT3__ Technic - Maharam	14	18	•			•	•	•	•	•			•	•	•							•	•	7
Price Category F																								
ZAY__ Alloy [N] - Maharam																								•
82T__ Apt [N] - Maharam		18	•			•	•	•	•	•			•	•	•			•	21	•		•	•	7
871__ Brindle - Maharam	14	16	16			•	•	•	•	•			•	•	•			•				•	•	•
ZCH__ Chock - Maharam			•										•	•	•									7
ZC8__ Coin - Maharam	14	•	16										•	•	•									•
ZCJ__ Coincide - Maharam		16	•										•	•	•									7
87Z__ Conduit - Maharam	14	16	16			•	•	•	•	•			•	•	•			•						7
VS__ Crush - Maharam						•	•													•				7
ZD1__ Disc - Maharam	14	18	16										•	•	•									•
ZD3__ Divide - Maharam	14	18	•										•	•	•									•
ZEE__ Exchange - Maharam	14	18	16			•	•	•	•	•			•	•	•			20						•
74M__ Instill [N] - Maharam	15	18	16			•	•	•	•	•			•	•	•			•	•		•	•	•	7
VgG__ Ledger - Maharam [N]	15	18	16			•	•	•	•	•			•	•	•									•
Z29__ Plait - Maharam	14	16	•			•	•	•	•	•			•	•	•					•				•
ZRV__ Rove - Maharam	14	16	•			•	•	•	•	•			•	•	•									7
ZRA__ Runner Standard - Maharam	14	18	•										•	•	•									7
Z31__ Sequence - Maharam	14	•	•			•	•	•	•	•			•	•	•				•					•
Z32__ Skein - Maharam	14	16	16	•									•	•	•									•
Z33__ Strum - Maharam [N]			16										•	•	•				•		•	•		7

continued on next page

* Available in select colors on 20-day lead-time.

Refer to "Maharam Colors - Seating" for 20-day colors.

Maharam® Application Chart — Seating *continued*

• Available

[A] Maharam textiles are on assigned lead times.

[N] Non-woven textile.

See below for exception notes.

Appendix: Maharam Application Chart — Seating

	Mirra® Chairs/Stools	Celle® Chairs	Sayl® Work Chairs/Stools	Sayl Side Chairs	Setu® Chairs/Stools	Setu Lounge Chair/Ottoman	Verus™ Work Chairs/Stools Back	Verus Work Chairs/Stools Seat	Verus Side Chairs Back	Verus Side Chairs Seat	Verus Plus Chairs	Aside® Chairs	Caper® Chairs/Stools	Keyn Chair Group Back	Keyn Chair Group Seat	Lino™ Chairs Seat	Locale® Bench Cushions	Public Office Landscape® Seat	Plex® Lounge Furniture	Swoop™ Lounge Seating - Fully Upholstered	Swoop Lounge Seating - Plywood	Valor™ Seating	Cushion Tops	Workspaces
Price Category G																								
ZC9__ Coin Crypton - Maharam			•	16			•								•									7
ZCF__ Coincide High Performance - Maharam	14	16	16				•		•						•									7
ZCQ__ Colline - Maharam																								7
ZC2__ Compound - Maharam [N]			16	16			•		•		8				•	•			•		•	•		7
T1__ Dart - Maharam				16			•		•						•	•				•				7
ZD4__ Divide Crypton - Maharam	14	16	•									•			•									7
ZEM__ Emboss - Maharam [N]		15		16											•									7
ZF1__ Fold - Maharam [N]		15		16											•									7
ZH1__ Hero by Kvadrat - Maharam	14	•	16				•	•	•	•	•	•		•	•	•						•		7
ZPR__ Pare - Maharam	14	18	16				•		•		8				•	•		•	•	•				7
ZP1__ Pick Crypton - Maharam	14	16	•									•			•	•								7
V26__ Remix - Maharam			16	16										•	•				•		•		•	7
ZRF__ Runner - Maharam	14	16	16												•									•
ZSN__ Sheen - Maharam	14	18	•				•	•	•		•				•									7
ZSE__ Steelcut - Maharam			•	•			•	•	•						•	•			•					7
ZS1__ Stride - Maharam	14	•	•									•			•	•								7
ZVT__ Vestige - Maharam	14	18	•									•			•	•								7
Price Category H																								
ZT__ Circles - Maharam	14	16	16												•									•
ZS__ Crosspatch - Maharam	14		•												•									•
Z2D__ Ditto - Maharam	14	•	16												•					•				•
Z23__ Divina MD - Maharam	14	•	16	•			•	•	•	•	•			•	•	•			•	•	•	•	•	•
TG__ Divina Melange - Maharam	14	•	•	•	•	•	•	•	•	•	•	8		•	•	•			•	•	•	•	•	•
TF__ Divina - Maharam	14	•	•	•	•	•	•	•	•	•	•	8		•	•	•			•	•	•	•	•	•
ZK__ Dot Pattern - Maharam	14	•	•	•	•		•		•			•			•									•
ZQF__ Offset - Maharam	14	16	•									•			•									•
ZP3__ Pocket - Maharam	14	•					•		•					•	•					•				•
ZL__ Small Dot Pattern - Maharam	14	•	•	•	•		•		•			•			•					•				•
V25__ Steelcut Trio - Maharam	14	16	•					•							•				•			•	•	•
ZTN__ Tonus - Maharam			16	16												•			•					7
Price Category I																								
7CW__ Cursive - Maharam	14	16	16				•	•	•	•	8			•	•	•	•		•					•
ZSY__ Study - Maharam																							•	
ZT2__ Teatro - Maharam			•	•			•		•															7
Price Category J																								
Z24__ Hallingdal - Maharam	14	•	•	•			•	•	•	•				•	•	•			•		•			•
Price Category K																								
ZC7__ Coda by Kvadrat - Maharam	14	16	16								•										•	•	•	
Price Category L																								
ZMK__ Minicheck - Maharam	14	•	•									•			•	•								7
Price Category M																								
ZF2__ Fruit - Maharam	14		16									•												7
Price Category N-Z																								
No fabrics available at this time.																								

7 Available on 1" Cushion Tops only.

8 Only available on the Aside nonupholstered outer back option (PB).

14 Available on Celle UC (upholstered seat) and Celle UF (upholstered seat) chairs.

15 Available only on Celle HC (upholstered seat with protective edge) and Celle HF (upholstered seat) chairs.

16 Available on Sayl Chair seat.

18 Available on Sayl Chair seat and upholstered mid-back.

20 Not available on Plex Club Chair with Headrest.

21 Available on Plex seat and on Ottoman.

26 Available in select colors. Refer to "Maharam Textile Colors - Seating" for color offering.

Maharam® Colors — Seating

Price Category 1-2

No fabrics available at this time.

Price Category 3

Meld – Maharam

54" wide
68% post-consumer recycled polyester
32% polyester
PFOA-Free stain resistant

ZM201/466387-201	Vast
ZM202/466387-202	Panda *
ZM203/466387-203	Skyline *
ZM204/466387-204	Knight *
ZM205/466387-205	Quill **
ZM206/466387-206	Pipe
ZM207/466387-207	Grate *
ZM208/466387-208	Gloss
ZM209/466387-209	Bulb
ZM210/466387-210	Bride
ZM211/466387-211	Stark
ZM212/466387-212	Seashell
ZM213/466387-213	Antler
ZM214/466387-214	Crater *
ZM215/466387-215	Perennial
ZM216/466387-216	Mulberry
ZM217/466387-217	Fuchsia *
ZM218/466387-218	Amethyst *
ZM219/466387-219	Merlot
ZM220/466387-220	Magma *
ZM221/466387-221	Rooster
ZM222/466387-222	Heat *
ZM223/466387-223	Clementine
ZM224/466387-224	Fox
ZM225/466387-225	Kiss *
ZM226/466387-226	Bare
ZM227/466387-227	Blonde
ZM228/466387-228	Mimosa
ZM229/466387-229	Comet *
ZM230/466387-230	Honeydew
ZM231/466387-231	Wild *
ZM232/466387-232	Vine
ZM233/466387-233	Seed
ZM234/466387-234	Kale *

* Colors available on
20-day lead time.

** Colors available on
10-day lead time.

Meld continued

ZM235/466387-235	Waterfall *
ZM236/466387-236	Nordic *
ZM237/466387-237	Reef *
ZM238/466387-238	Wave
ZM239/466387-239	Isle **
ZM240/466387-240	Creek
ZM241/466387-241	Mariner *
ZM242/466387-242	Globe
ZM243/466387-243	Spa

Price Category 4-9

No fabrics available at this time.

- Maharam textiles are on assigned lead times A unless otherwise noted.
- Fabric numbers are listed as Herman Miller fabric number/Maharam fabric number.

Maharam® Colors — Seating

continued

Price Category A

No fabrics available at this time.

Price Category B

Medium – Maharam

54" wide

100% polyester

VM01/463490-001	Raven
VM02/463490-002	Smoke
VM03/463490-003	Alloy
VM04/463490-004	Flax
VM06/463490-006	Bark
VM07/463490-007	Espresso
VM08/463490-008	Pecan
VM12/463490-012	Pumpkin
VM13/463490-013	Persimmon
VM14/463490-014	Laser
VM16/463490-016	Port
VM22/463490-022	Marina
VM29/463490-029	Pistachio
VM32/463490-032	Prospect
VM36/463490-036	Delight
VM39/463490-039	Nautical
VM40/463490-040	Pool
VM44/463490-044	Washed
VM45/463490-045	Sculpture
VM46/463490-046	Thatched
VM47/463490-047	Hike
VM48/463490-048	Tangle
VM49/463490-049	Pacific
VM50/463490-050	Cosmic
VM51/463490-051	Cascade
VM52/463490-052	Blackberry
VM53/463490-053	Nasturtium
VM54/463490-054	Wooded

Messenger – Maharam

54" wide

78% recycled polyester

15% polyester, 7% nylon

T107/458640-007	Shadow
T108/458640-008	Bayou *
T124/458640-024	Poppy
T125/458640-025	Mao
T129/458640-029	Onyx *
T131/458640-031	Cloud *
T138/458640-038	Depth *
T140/458640-040	Nile *
T141/458640-041	Azure *
T145/458640-045	Cactus *
T146/458640-046	Ice *
T148/458640-048	Neon
T150/458640-050	Hydrangea
T153/458640-053	Tangelo
T154/458640-054	Lumine *
T158/458640-058	Snow **
T160/458640-060	Peridot
T161/458640-061	Capri *
T162/458640-062	Ultramarine
T163/458640-063	Squall
T166/458640-066	Cassis
T167/458640-067	Aster
T169/458640-069	Cherry
T170/458640-070	Vibrant
T171/458640-071	Satsuma *
T172/458640-072	Maize

Messenger continued

T176/458640-076	Fossil
T177/458640-077	Ash
T178/458640-078	Tusk
T179/458640-079	Oyster
T181/458640-081	Husk
T184/458640-084	Robust
T185/458640-085	Beyond
T186/458640-086	Voyage *
T187/458640-087	Everglade
T189/458640-089	Blanch **
T190/458640-090	Longspur
T191/458640-091	Vireo
T192/458640-092	Dipper
T193/458640-093	Gale
T194/458640-094	Hunter
T195/458640-095	Lime
T196/458640-096	Apple
T197/458640-097	Krill
T198/458640-098	Catalyst

* Colors available on 20-day lead time.

** Colors not available on Valor Seating.

- Maharam textiles are on assigned lead times A unless otherwise noted.
- Fabric numbers are listed as Herman Miller fabric number/Maharam fabric number.

Maharam® Colors — Seating

continued

Price Category C

Lariat – Maharam

54" wide	
100% vinyl	
ZLR01/440401-001	001
ZLR02/440401-002	002
ZLR03/440401-003	003
ZLR04/440401-004	004
ZLR06/440401-006	006
ZLR07/440401-007	007
ZLR08/440401-008	008
ZLR10/440401-010	010
ZLR11/440401-011	011
ZLR12/440401-012	012
ZLR13/440401-013	013
ZLR14/440401-014	014
ZLR15/440401-015	015
ZLR16/440401-016	016
ZLR18/440401-018	018
ZLR20/440401-020	020
ZLR21/440401-021	021
ZLR23/440401-023	023
ZLR24/440401-024	024
ZLR25/440401-025	025
ZLR26/440401-026	026
ZLR27/440401-027	027
ZLR28/440401-028	028
ZLR29/440401-029	029
ZLR30/440401-030	030
ZLR31/440401-031	031
ZLR32/440401-032	032
ZLR33/440401-033	033
ZLR34/440401-034	034
ZLR35/440401-035	035
ZLR36/440401-036	036
ZLR37/440401-037	037
ZLR38/440401-038	038

Manner - Maharam

54" wide	
100% recycled polyester	
Z2701/466177-001	Magic
Z2702/466177-002	Carob
Z2703/466177-003	Porpoise
Z2704/466177-004	Flint
Z2705/466177-005	Hush
Z2706/466177-006	Nuance
Z2711/466177-011	Ember
Z2712/466177-012	Wagon
Z2713/466177-013	Ablaze
Z2714/466177-014	Peel
Z2716/466177-016	Butterscotch
Z2717/466177-017	Harvest
Z2720/466177-020	Parakeet
Z2722/466177-022	Aquatic
Z2723/466177-023	Cottage
Z2724/466177-024	Dahlia
Z2725/466177-025	Vivid
Z2726/466177-026	Basin
Z2727/466177-027	Schooner
Z2728/466177-028	Slope
Z2729/466177-029	Silverpoint
Z2730/466177-030	Lattice
Z2731/466177-031	Smoky
Z2732/466177-032	Magnetic
Z2733/466177-033	Woad
Z2734/466177-034	Resolute
Z2735/466177-035	Cruise
Z2736/466177-036	Atmospheric
Z2737/466177-037	Cloudburst
Z2738/466177-038	Tidewater
Z2739/466177-039	Firth
Z2740/466177-040	Oceanside
Z2741/466177-041	Grandeur
Z2742/466177-042	Comfort
Z2743/466177-043	Dill
Z2744/466177-044	Poplar
Z2745/466177-045	Citronella
Z2746/466177-046	Passerine

Manner continued

Z2747/466177-047	Southwest
Z2748/466177-048	Roseate
Z2749/466177-049	Charisma
Z2750/466177-050	Siltstone
Z2751/466177-051	Kimono
Z2752/466177-052	Valiant
Z2753/466177-053	Baroness

Merit - Maharam

54" wide	
76% post-industrial recycled polyester	
24% polyester	
PFOA-Free stain resistant	
88Z01/466444-001	Trickle
88Z02/466444-002	Beluga
88Z03/466444-003	Gunmetal
88Z04/466444-004	Blackout
88Z05/466444-005	Superior
88Z06/466444-006	Ocean
88Z07/466444-007	Highborn
88Z08/466444-008	Immersed
88Z09/466444-009	Rainfall
88Z10/466444-010	Blizzard
88Z11/466444-011	Poolside
88Z12/466444-012	Steel
88Z13/466444-013	Zircon
88Z14/466444-014	Ripple
88Z15/466444-015	Aegean
88Z16/466444-016	Armada
88Z17/466444-017	Hedera
88Z18/466444-018	Rainforest
88Z19/466444-019	Gator
88Z20/466444-020	Vineyard
88Z21/466444-021	Pine
88Z22/466444-022	Kiwi
88Z23/466444-023	Kookaburra
88Z24/466444-024	Bellini
88Z25/466444-025	Sunflower
88Z26/466444-026	Sandstorm

Merit continued

88Z27/466444-027	Mudder
88Z28/466444-028	Lynx
88Z29/466444-029	Farro
88Z30/466444-030	Manila
88Z31/466444-031	Starfish
88Z32/466444-032	Brass
88Z33/466444-033	Arrow
88Z34/466444-034	Gelato
88Z35/466444-035	Nectarine
88Z36/466444-036	Macaron
88Z37/466444-037	Alert
88Z38/466444-038	Goji
88Z39/466444-039	Cabernet
88Z40/466444-040	Eggplant
88Z41/466444-041	Hawk
88Z42/466444-042	Stag
88Z43/466444-043	Overcast

Metric – Maharam

54" wide	
51% recycled polyester	
49% polyester	
Z302/466014-002	Fog
Z303/466014-003	Fleece
Z312/466014-012	Cardinal
Z313/466014-013	Lava
Z318/466014-018	Pollen
Z320/466014-020	Alligator
Z323/466014-023	Tar
Z324/466014-024	Anchor
Z326/466014-026	Admiral
Z327/466014-027	Seaport
Z328/466014-028	Scuba
Z329/466014-029	Skate
Z330/466014-030	Hopscotch
Z331/466014-031	Film
Z332/466014-032	Whale
Z333/466014-033	Downpour
Z334/466014-034	Midday
Z335/466014-035	Talisman

Price category C continued on next page

- Maharam textiles are on assigned lead times ^A unless otherwise noted.
- Fabric numbers are listed as Herman Miller fabric number/Maharam fabric number.

Maharam® Colors – Seating

continued

Price Category C

continued

Metric continued

Z336/466014-036	Hedgerow
Z337/466014-037	Snorkel
Z338/466014-038	Highway
Z339/466014-039	Canary
Z340/466014-040	Sunny
Z341/466014-041	Aztec
Z342/466014-042	Fruit
Z343/466014-043	Galah
Z344/466014-044	Kiln
Z345/466014-045	Moth

Milestone – Maharam

54" wide	
78% post-industrial recycled polyester	
15% polyester	
7% nylon	
ZML22/403901-022	Pewter
ZML25/403901-025	Charcoal
ZML26/403901-026	Ebony
ZML29/403901-029	Medium Grey
ZML31/403901-031	Ground
ZML46/403901-046	Tortoise
ZML47/403901-047	Rush
ZML54/403901-054	Linger
ZML55/403901-055	Embrace
ZML57/403901-057	Coffee
ZML58/403901-058	Bison
ZML61/403901-061	Tiger Lily
ZML62/403901-062	Aurora
ZML69/403901-069	Lychee
ZML71/403901-071	Daffodil
ZML72/403901-072	Ecrú
ZML77/403901-077	Basil
ZML78/403901-078	Spruce
ZML79/403901-079	Fountain
ZML80/403901-080	Mykonos

Murmur - Maharam

55" wide	
100% polyester	
PFOA-Free stain resistant	
8EY01/466446-001	Gust
8EY02/466446-002	Harmonica
8EY03/466446-003	Canopy
8EY04/466446-004	Dim
8EY05/466446-005	Peppercorn
8EY06/466446-006	Cauldron
8EY07/466446-007	Conquer
8EY08/466446-008	Rapids
8EY09/466446-009	Seawater
8EY10/466446-010	Baby
8EY11/466446-011	Elderberry
8EY12/466446-012	Iceberg
8EY13/466446-013	Tallgrass
8EY14/466446-014	Underground
8EY15/466446-015	Biome
8EY16/466446-016	Cask
8EY17/466446-017	Argan
8EY18/466446-018	Sundown
8EY19/466446-019	Ignite
8EY20/466446-020	Sultry
8EY21/466446-021	Sangria

Price Category D

Mode – Maharam

54" wide	
80% post-consumer recycled polyester	
20% polyester	
PFOA-Free stain resistant finish	
ZMD01/466337-001	Stroll
ZMD02/466337-002	Intaglio
ZMD03/466337-003	Ominous
ZMD04/466337-004	Machine
ZMD05/466337-005	Talus
ZMD06/466337-006	Marsh
ZMD07/466337-007	Hollow
ZMD08/466337-008	Sycamore
ZMD09/466337-009	Clavicle
ZMD10/466337-010	Billygoat
ZMD11/466337-011	Spindle
ZMD12/466337-012	Lemon
ZMD13/466337-013	Oxeye
ZMD14/466337-014	Henge
ZMD15/466337-015	Goldenrod
ZMD16/466337-016	Cottontail
ZMD17/466337-017	Lioness
ZMD18/466337-018	Oriole
ZMD19/466337-019	Rust
ZMD20/466337-020	Carotene
ZMD21/466337-021	Blush
ZMD22/466337-022	Vermilion
ZMD23/466337-023	Alder
ZMD24/466337-024	Kermes
ZMD25/466337-025	Barberry
ZMD26/466337-026	Petal
ZMD27/466337-027	Valley
ZMD28/466337-028	Odyssey
ZMD29/466337-029	Ballpoint
ZMD30/466337-030	Toile
ZMD31/466337-031	Paradise
ZMD32/466337-032	Angelfish
ZMD33/466337-033	Denim
ZMD34/466337-034	Crush

Mode continued

ZMD35/466337-035	Jetty
ZMD36/466337-036	Saltwater
ZMD37/466337-037	Mallard
ZMD38/466337-038	Celtic
ZMD39/466337-039	Eucalyptus
ZMD40/466337-040	Bonsai
ZMD41/466337-041	Sassafras
ZMD42/466337-042	Yucca
ZMD43/466337-043	Lichen

- Maharam textiles are on assigned lead times ^A unless otherwise noted.
- Fabric numbers are listed as Herman Miller fabric number/Maharam fabric number.

Maharam® Colors — Seating

continued

Price Category E

Article – Maharam
54" wide
100% vinyl
ZAT08/458600-008 Marina
ZAT13/458600-013 Flume
ZAT14/458600-014 Storm
ZAT15/458600-015 Toast
ZAT19/458600-019 Fleece
ZAT22/458600-022 Stone
ZAT26/458600-026 Mercury
ZAT29/458600-029 Bluegrass
ZAT31/458600-031 Truffle
ZAT32/458600-032 Gravel
ZAT33/458600-033 Value
ZAT34/458600-034 Tint
ZAT35/458600-035 Snowflake
ZAT36/458600-036 Chalice
ZAT37/458600-037 Trail
ZAT38/458600-038 Pyramid
ZAT39/458600-039 Desert
ZAT40/458600-040 Lei
ZAT41/458600-041 Rouge
ZAT42/458600-042 Karma
ZAT43/458600-043 Opal
ZAT44/458600-044 Periwinkle
ZAT45/458600-045 Vampire
ZAT46/458600-046 Surf
ZAT47/458600-047 Plumage

Dwell - Maharam
54" wide
68% post-industrial recycled polyester
32% post-consumer recycled polyester
PFOA-Free stain resistant
Latex backing
89601/466419-001 Sesame
89602/466419-002 Summit
89603/466419-003 Freeze
89604/466419-004 Poolside
89605/466419-005 Teal
89606/466419-006 Mojito
89607/466419-007 Lizard
89608/466419-008 Thunder
89609/466419-009 Foil
89610/466419-010 Wine
89611/466419-011 Firecracker

Focus - Maharam
57" wide
54% post-industrial recycled polyester
33% polyester
13% post-consumer recycled polyester
ZFS02/465910-002 Allow *
ZFS07/465910-007 Merlot
ZFS09/465910-009 Carbon
ZFS10/465910-010 Regatta

* Color not available on Valor Seating.

Oblique - Maharam
58" wide
100% polyester
with stain resistant finish
ZBQ01/466222-001 001
ZBQ02/466222-002 002
ZBQ03/466222-003 003
ZBQ04/466222-004 004
ZBQ05/466222-005 005
ZBQ06/466222-006 006
ZBQ07/466222-007 007

Pick - Maharam
58" wide
100% polyester
with stain resistant finish
ZP201/466224-001 001
ZP202/466224-002 002
ZP203/466224-003 003
ZP204/466224-004 004
ZP205/466224-005 005
ZP206/466224-006 006
ZP207/466224-007 007
ZP208/466224-008 008
ZP209/466224-009 009
ZP210/466224-010 010

Technic - Maharam
56" wide
60% post-industrial recycled polyester
40% post-consumer recycled polyester
PFOA-Free stain resistant finish
Acrylic backing
ZT301/466226-001 Cumin
ZT302/466226-002 Evergreen
ZT303/466226-003 Cobalt
ZT304/466226-004 Bear
ZT305/466226-005 Squirrel

Price Category F

Alloy - Maharam
54" wide
100% polyurethane
ZAY01/466064-001 Chalk
ZAY02/466064-002 Oat
ZAY03/466064-003 Chamomile
ZAY04/466064-004 Navel
ZAY05/466064-005 Sultry
ZAY06/466064-006 Aubergine
ZAY07/466064-007 Truffle
ZAY08/466064-008 Peat
ZAY09/466064-009 Sapling
ZAY10/466064-010 Peacock
ZAY11/466064-011 Rave
ZAY12/466064-012 Baltic
ZAY13/466064-013 Lapis
ZAY14/466064-014 Indigo
ZAY15/466064-015 Heron
ZAY16/466064-016 Covert
ZAY17/466064-017 Zinc
ZAY18/466064-018 Mercury
ZAY19/466064-019 Flint
ZAY20/466064-020 Carbonite

Apt – Maharam
54" wide
100% polyurethane/silicone
Ink-resistant protective top coat
Polyester backing
82T01/466392-001 Coconut
82T02/466392-002 Vibe
82T03/466392-003 Stampede
82T04/466392-004 Lumber
82T05/466392-005 Gingerbread
82T06/466392-006 Hickory
82T07/466392-007 Constellation
82T08/466392-008 Labyrinth
82T09/466392-009 Sketch
82T10/466392-010 Glacier
82T11/466392-011 Cobblestone
82T12/466392-012 Iris
82T13/466392-013 Nocturnal

Price category F continued on next page

- Maharam textiles are on assigned lead times ^A unless otherwise noted.
- Fabric numbers are listed as Herman Miller fabric number/Maharam fabric number.

Maharam® Colors — Seating

continued

Price Category F

continued

Apt continued

82T14/466392-014	Fluid
82T15/466392-015	Eden
82T16/466392-016	Galactic
82T17/466392-017	Shoreline
82T18/466392-018	Jade
82T19/466392-019	Garden
82T20/466392-020	Botanic
82T21/466392-021	Chartreuse
82T22/466392-022	Crepe
82T23/466392-023	Lyric
82T24/466392-024	Turmeric
82T25/466392-025	Bengal
82T26/466392-026	Core
82T27/466392-027	Mantle
82T28/466392-028	Sorbet
82T29/466392-029	Bloom
82T30/466392-030	Lotus
82T31/466392-031	Fortress
82T32/466392-032	Oak
82T33/466392-033	Castle
82T34/466392-034	Follow
82T35/466392-035	Elixir
82T36/466392-036	Charm
82T37/466392-037	Descend

Brindle - Maharam

58" wide	
100% polyester	
PFOA-free stain resistant	
Acrylic backing	
87101/466418-001	Calico
87102/466418-002	Mauve
87103/466418-003	Torch
87104/466418-004	Burnt
87105/466418-005	Barn
87106/466418-006	Pharaoh
87107/466418-007	Sandbur
87108/466418-008	Jungle
87109/466418-009	Inland
87110/466418-009	Seagrass
87111/466418-009	Watercolor
87112/466418-009	Aquarium
87113/466418-009	Drill

Chock - Maharam

59" wide	
36% rayon	
35% cotton	
29% solution-dyed post-industrial recycled nylon	
PFOA-Free stain resistant finish	
Acrylic backing	
ZCH01/466219-001	Beige
ZCH02/466219-002	Stone
ZCH04/466219-004	Red
ZCH07/466219-007	Smoke
ZCH08/466219-008	Ebony

Coin - Maharam

57" wide	
43% polyester	
37% post-industrial recycled polyester	
20% post-consumer recycled polyester	
PFOA-Free stain resistant finish	
Acrylic backing	
ZC801/466233-001	Nickel
ZC803/466233-003	Copper
ZC804/466233-004	Maroon
ZC805/466233-005	Penny
ZC806/466233-006	Exchange
ZC807/466233-007	Lead

Coincide - Maharam

54" wide	
100% polyester	
ZCJ01/465808-001	Mist
ZCJ02/465808-002	Drizzle
ZCJ03/465808-003	Cicada
ZCJ04/465808-004	Bungalow
ZCJ05/465808-005	Aurora
ZCJ06/465808-006	Currant
ZCJ07/465808-007	Raisin
ZCJ08/465808-008	Tranquil
ZCJ09/465808-009	Caribbean
ZCJ10/465808-010	Woodland
ZCJ11/465808-011	Acre

Conduit - Maharam

58" wide	
100% polyester	
PFOA-free stain resistant	
Acrylic backing	
87Z01/466428-001	Space
87Z02/466428-002	Syrup
87Z03/466428-003	Nimbus
87Z04/466428-004	Greystone
87Z05/466428-005	Fawn
87Z06/466428-006	Ghost
87Z07/466428-007	Caribbean
87Z08/466428-008	Canal
87Z09/466428-009	Bonfire

Crush - Maharam

54" wide	
85% solution-dyed nylon	
13% polyester	
2% polyolefin	
VS01/464780-001	001
VS02/464780-002	002
VS05/464780-005	005
VS08/464780-008	008
VS13/464780-013	013
VS16/464780-016	016
VS17/464780-017	017
VS18/464780-018	018
VS19/464780-019	019
VS20/464780-020	020
VS22/464780-022	022
VS23/464780-023	023
VS26/464780-026	026
VS27/464780-027	027

Disc - Maharam

57" wide	
100% polyester	
PFOA-Free stain resistant finish	
Acrylic backing	
ZD101/466221-001	Nude
ZD102/466221-002	Khaki
ZD103/466221-003	Festive
ZD104/466221-004	Vibrant
ZD105/466221-005	Somber
ZD106/466221-006	Warm
ZD107/466221-007	Steel

Divide - Maharam

57" wide	
45% polyester	
36% post-industrial recycled polyester	
19% post-consumer recycled polyester	
PFOA-Free stain resistant finish	
Acrylic backing	
ZD301/466220-001	Ecru
ZD302/466220-002	Café
ZD303/466220-003	Concrete
ZD304/466220-004	Forest
ZD305/466220-005	Tropic
ZD306/466220-006	Lagoon
ZD307/466220-007	Mocha
ZD308/466220-008	Singe
ZD309/466220-009	Cayenne

Exchange - Maharam

58" wide	
58% post-industrial recycled polyester	
42% post-consumer recycled polyester	
ZEE01/466027-001	Cinder
ZEE02/466027-002	Sable
ZEE04/466027-004	Gull
ZEE06/466027-006	Coastline
ZEE07/466027-007	Clay
ZEE08/466027-008	Buck
ZEE10/466027-010	Rhubarb
ZEE11/466027-011	Punch

Price category F continued on next page

- Maharam textiles are on assigned lead times **A** unless otherwise noted.
- Fabric numbers are listed as Herman Miller fabric number/Maharam fabric number.

Maharam® Colors – Seating

continued

Price Category F

continued

Instill – Maharam	
54" wide	
100% polyurethane	
Ink-resistant protective top coat	
Polyester backing	
74M01/466351-001	Page
74M02/466351-002	Limestone
74M03/466351-003	Bobwhite
74M04/466351-004	Loafer
74M05/466351-005	Moor
74M06/466351-006	Barley
74M07/466351-007	Shaker
74M08/466351-008	Doe
74M09/466351-009	Ride
74M10/466351-010	Squire
74M11/466351-011	Tannin
74M12/466351-012	Vitis
74M13/466351-013	Sonar
74M14/466351-014	Quail
74M15/466351-015	Brittanic
74M16/466351-016	Narwhal
74M17/466351-017	Synth
74M18/466351-018	Stowaway
74M19/466351-019	Koala
74M20/466351-020	Dorsal
74M21/466351-021	Stealth

Ledger – Maharam	
54" wide	
100% polyurethane	
V9G1/463770-001	001
V9G2/463770-002	002
V9G3/463770-003	003
V9G4/463770-004	004
V9GG/463770-017	017
V9GM/463770-022	022
V9GQ/463770-025	025
V9GS/463770-026	026
V9GU/463770-028	028
V9GV/463770-029	029
V9GW/463770-030	030
V9GX/463770-031	031
V9GY/463770-032	032
V9GZ/463770-033	033

Ledger continued	
V9G11/463770-035	035
V9G12/463770-036	036
V9G13/463770-037	037
V9G15/463770-039	039
V9G16/463770-040	040
V9G17/463770-041	041
V9G18/463770-042	042
V9G19/463770-043	043
V9G20/463770-044	044
V9G21/463770-045	045
V9G22/463770-046	046

Plait - Maharam	
58" wide	
68% recycled polyester	
32% polyester	
Z2901/466052-001	Cobblestone
Z2902/466052-002	Sachet
Z2904/466052-004	Tavern
Z2905/466052-005	Sequoia
Z2906/466052-006	Rhubarb
Z2907/466052-007	Sangria
Z2908/466052-008	Reef
Z2909/466052-009	Stormy
Z2910/466052-010	Dapper

Rove - Maharam	
54" wide	
100% solution-dyed polyolefin with silver-based antimicrobial	
ZRV01/466096-001	Rice
ZRV02/466096-002	Soba
ZRV03/466096-003	Owl
ZRV04/466096-004	Till
ZRV05/466096-005	Dijon
ZRV06/466096-006	Mum
ZRV07/466096-007	Nasturtium
ZRV08/466096-008	Vixen
ZRV09/466096-009	Roast
ZRV11/466096-011	Rind
ZRV12/466096-012	Grackle
ZRV13/466096-013	Indigo
ZRV14/466096-014	Drip
ZRV16/466096-016	Pomelo

Runner Standard - Maharam	
58" wide	
57% post-industrial recycled polyester	
43% post-consumer recycled polyester	
ZRA07/466167-007	Bluff
ZRA08/466167-008	Arid
ZRA09/466167-009	Grove
ZRA10/466167-010	Starboard
ZRA11/466167-011	Plot
ZRA12/466167-012	Carousel

Sequence - Maharam	
54" wide	
100% solution-dyed polyolefin with silver-based antimicrobial	
Z3101/466179-001	Driftwood
Z3102/466179-002	Boardwalk
Z3103/466179-003	Rattan
Z3104/466179-004	Alfresco
Z3105/466179-005	Plunge
Z3106/466179-006	Starboard
Z3107/466179-007	Veranda
Z3108/466179-008	Lodge
Z3109/466179-009	Flare

Skein - Maharam	
54" wide	
56% recycled polyester	
44% polyester	
Z3201/466170-001	Burrow
Z3204/466170-004	Sumac
Z3205/466170-005	Pomegranate
Z3206/466170-006	Cavern
Z3207/466170-007	Bitter
Z3208/466170-008	Cinder
Z3209/466170-009	Dock
Z3210/466170-010	Cadet
Z3211/466170-011	Marsh

Strum - Maharam	
54" wide	
100% polyurethane with silver-based antimicrobial	
Z3301/466122-001	Overcast
Z3302/466122-002	Ridge
Z3304/466122-004	Pigeon
Z3305/466122-005	Char
Z3306/466122-006	Cabin
Z3307/466122-007	Bur
Z3308/466122-008	Abalone
Z3309/466122-009	Prawn
Z3310/466122-010	Gourd
Z3311/466122-011	Wheat
Z3312/466122-012	Lemongrass

Appendix: Maharam Colors – Seating

- Maharam textiles are on assigned lead times A unless otherwise noted.
- Fabric numbers are listed as Herman Miller fabric number/Maharam fabric number.

Maharam® Colors — Seating

continued

Price Category G

Coin Crypton - Maharam	
54" wide	
43% polyester	
37% post-industrial recycled polyester	
20% post-consumer recycled polyester	
Crypton Green finish and backing	
ZC901/466236-001	Nickel
ZC905/466236-005	Penny
ZC906/466236-006	Exchange
ZC907/466236-007	Lead

Coincide High Performance-Maharam	
54" wide	
100% polyester	
ZCF02/466132-002	Drizzle
ZCF03/466132-003	Cicada
ZCF04/466132-004	Bungalow
ZCF11/466132-011	Acre

Colline - Maharam	
55" wide	
75% wool	
17% acrylic	
8% nylon	
ZCQ01/466155-108	108
ZCQ02/466155-118	118
ZCQ03/466155-148	148
ZCQ04/466155-188	188
ZCQ05/466155-228	228
ZCQ06/466155-348	348
ZCQ07/466155-448	448
ZCQ08/466155-548	548
ZCQ09/466155-568	568
ZCQ10/466155-668	668
ZCQ11/466155-688	688
ZCQ12/466155-788	788

Compound - Maharam	
54" wide	
100% polyurethane	
silane-based antimicrobial	
ZC201/466196-001	001
ZC202/466196-002	002
ZC203/466196-003	003
ZC204/466196-004	004
ZC205/466196-005	005
ZC206/466196-006	006
ZC207/466196-007	007
ZC208/466196-008	008
ZC209/466196-009	009
ZC210/466196-010	010
ZC211/466196-011	011
ZC212/466196-012	012
ZC213/466196-013	013
ZC214/466196-014	014
ZC215/466196-015	015
ZC216/466196-016	016
ZC217/466196-017	017
ZC218/466196-018	018
ZC219/466196-019	019

Dart - Maharam	
54" wide	
63% polyester	
37% cotton	
T104/464040-004	Bartlett
T106/464040-006	Beeswax
T114/464040-014	Cajole
T116/464040-016	Nightshade
T117/464040-017	Scribe
T118/464040-018	Shale
T120/464040-020	Ardor
T122/464040-022	Maize
T123/464040-023	Wade
T124/464040-024	Flood

Divide Crypton - Maharam	
57" wide	
45% polyester	
36% post-industrial recycled polyester	
19% post-consumer recycled polyester	
Crypton Green finish and backing	
ZD401/466238-001	Ecru
ZD402/466238-002	Café
ZD403/466238-003	Concrete
ZD404/466238-004	Forest
ZD405/466238-005	Tropic
ZD406/466238-006	Lagoon
ZD407/466238-007	Mocha
ZD408/466238-008	Singe

Emboss - Maharam	
54" wide	
100% polyurethane	
Polyester backing	
ZEM01/466281-001	Bronze
ZEM02/466281-002	Brass
ZEM03/466281-003	Gold
ZEM04/466281-004	Platinum
ZEM05/466281-005	Silver
ZEM06/466281-006	Aqua
ZEM07/466281-007	Aegean
ZEM08/466281-008	Cobalt
ZEM09/466281-009	Ultraviolet
ZEM10/466281-010	Copper
ZEM11/466281-011	Molten

Fold - Maharam	
54" wide	
100% polyurethane	
Polyester backing	
ZF101/466292-001	Jet
ZF102/466292-002	Chalk
ZF103/466292-003	Smoke
ZF104/466292-004	Putty
ZF105/466292-005	Fatigue
ZF106/466292-006	Splash
ZF107/466292-007	Apple
ZF108/466292-008	Moss
ZF109/466292-009	Graphite
ZF110/466292-010	Midnight

Hero by Kvadrat - Maharam	
55" wide	
96% wool	
4% nylon	
ZH101/466318-101	101
ZH102/466318-141	141
ZH103/466318-151	151
ZH104/466318-181	181
ZH105/466318-191	191
ZH106/466318-201	201
ZH107/466318-211	211
ZH108/466318-231	231
ZH109/466318-311	311
ZH110/466318-381	381
ZH111/466318-411	411
ZH112/466318-441	441
ZH113/466318-451	451
ZH114/466318-481	481
ZH115/466318-511	511
ZH116/466318-541	541
ZH117/466318-551	551
ZH118/466318-601	601
ZH119/466318-681	681
ZH120/466318-701	701
ZH121/466318-711	711
ZH122/466318-751	751
ZH123/466318-791	791
ZH124/466318-901	901
ZH125/466318-931	931
ZH126/466318-941	941
ZH127/466318-981	981
ZH128/466318-991	991

Pare - Maharam	
54" wide	
52% wool	
26% polyester	
22% nylon	
PFOA-free stain resistant finish	
ZPR01/466359-001	Polaris
ZPR02/466359-002	Mountain
ZPR03/466359-003	Mineral
ZPR04/466359-004	Fresco
ZPR05/466359-005	Blossom
ZPR06/466359-006	Wink

- Maharam textiles are on assigned lead times **A** unless otherwise noted.
- Fabric numbers are listed as Herman Miller fabric number/Maharam fabric number.

Price category G continued on next page

Maharam® Colors — Seating

continued

Price Category G

continued

Pare continued	
ZPR07/466359-007	Concord
ZPR08/466359-008	Strawberry
ZPR09/466359-009	Solar
ZPR10/466359-010	Amulet
ZPR11/466359-011	Zest
ZPR12/466359-012	Elmwood
ZPR13/466359-013	Thyme
ZPR14/466359-014	Frost
ZPR15/466359-015	Oasis
ZPR16/466359-016	Denim
ZPR17/466359-017	Blueberry

Pick Crypton - Maharam	
54" wide	
100% polyester	
Crypton finish and backing	
ZP103/466235-003	Slate
ZP105/466235-005	Pepper
ZP107/466235-007	Fresh
ZP108/466235-008	Cool
ZP109/466235-009	Ink

Remix - Maharam	
54" wide	
90% wool	
10% nylon	
V2601/465956-113	113
V2602/465956-123	123
V2603/465956-133	133
V2604/465956-143	143
V2605/465956-152	152
V2606/465956-163	163
V2607/465956-173	173
V2608/465956-183	183
V2609/465956-223	223
V2610/465956-233	233
V2611/465956-242	242
V2612/465956-252	252
V2613/465956-362	362
V2614/465956-373	373
V2615/465956-383	383
V2616/465956-393	393
V2617/465956-412	412

Remix continued	
V2618/465956-422	422
V2619/465956-433	433
V2620/465956-443	443
V2621/465956-452	452
V2622/465956-543	543
V2623/465956-612	612
V2624/465956-632	632
V2625/465956-643	643
V2626/465956-653	653
V2627/465956-662	662
V2628/465956-672	672
V2629/465956-682	682
V2630/465956-692	692
V2631/465956-722	722
V2632/465956-733	733
V2633/465956-743	743
V2634/465956-753	753
V2635/465956-762	762
V2636/465956-773	773
V2637/465956-783	783
V2638/465956-823	823
V2639/465956-842	842
V2640/465956-852	852
V2641/465956-873	873
V2642/465956-912	912
V2643/465956-923	923
V2644/465956-933	933
V2645/465956-942	942
V2646/465956-962	962
V2647/465956-973	973
V2648/465956-982	982
V2649/465956-954	954

Runner - Maharam	
54" wide	
57% post-industrial recycled polyester	
43% post-consumer recycled polyester	
ZRF01/466108-001	Bluff
ZRF02/466108-002	Arid
ZRF03/466108-003	Grove
ZRF04/466108-004	Starboard
ZRF05/466108-005	Plot
ZRF06/466108-006	Carousel

Sheen - Maharam	
54" wide	
100% polyurethane with silane-based antimicrobial	
ZSN02/466246-002	Silver
ZSN03/466246-003	Pewter
ZSN04/466246-004	Hearth
ZSN05/466246-005	Fern
ZSN07/466246-007	Cricket
ZSN09/466246-009	Mystic
ZSN10/466246-010	Vat
ZSN11/466246-011	Huckleberry
ZSN16/466246-016	Kumquat
ZSN17/466246-017	Cinnamon
ZSN18/466246-018	Alder

Steelcut - Maharam	
55" wide	
90% wool	
10% nylon	
ZSE01/464470-110	110
ZSE02/464470-120	120
ZSE03/464470-135	135
ZSE04/464470-140	140
ZSE05/464470-155	155
ZSE06/464470-160	160
ZSE07/464470-180	180
ZSE08/464470-190	190
ZSE09/464470-220	220
ZSE10/464470-240	240
ZSE11/464470-255	255
ZSE12/464470-265	265
ZSE13/464470-365	365
ZSE14/464470-370	370
ZSE15/464470-380	380
ZSE16/464470-435	435
ZSE17/464470-445	445
ZSE18/464470-535	535
ZSE19/464470-545	545
ZSE20/464470-550	550
ZSE21/464470-605	605
ZSE22/464470-615	615
ZSE23/464470-625	625
ZSE24/464470-635	635

Steelcut continued	
ZSE25/464470-655	655
ZSE26/464470-660	660
ZSE27/464470-685	685
ZSE28/464470-695	695
ZSE29/464470-760	760
ZSE30/464470-775	775
ZSE31/464470-780	780
ZSE32/464470-820	820
ZSE33/464470-835	835
ZSE34/464470-935	935
ZSE35/464470-950	950
ZSE36/464470-975	975
ZSE37/464470-985	985

Stride - Maharam	
58" wide	
40% post-industrial recycled polyester	
39% polyester	
21% post-consumer recycled polyester	
PFOA-Free stain resistant finish	
Acrylic backing	
ZS103/466252-003	Midnight
ZS104/466252-004	Moss
ZS106/466252-006	Ember

Vestige - Maharam	
54" wide	
71% polyester	
29% rayon	
ZVT01/466259-001	001
ZVT02/466259-002	002
ZVT03/466259-003	003
ZVT04/466259-004	004
ZVT05/466259-005	005
ZVT06/466259-006	006
ZVT07/466259-007	007
ZVT08/466259-008	008
ZVT09/466259-009	009
ZVT10/466259-010	010

- Maharam textiles are on assigned lead times ^A unless otherwise noted.
- Fabric numbers are listed as Herman Miller fabric number/Maharam fabric number.

Maharam® Colors — Seating

continued

Price Category H

Appendix: Maharam Colors — Seating

Circles — Maharam

55" wide	
70% cotton	
30% polyester	
ZT01/458310-001	Khaki
ZT02/458310-002	Fatigue
ZT03/458310-003	Document
ZT04/458310-004	Engine
ZT05/458310-005	Charcoal

Crosspatch — Maharam

54" wide	
75% rayon	
25% polyester	
ZS01/458920-001	Song
ZS04/458920-004	Document

Ditto — Maharam

54" wide	
77% recycled polyester	
23% solution dyed nylon	
Z2D1/465993-001	Nacre
Z2D2/465993-002	Shadow
Z2D3/465993-003	Saddle
Z2D9/465993-009	Fern
Z2DA/465993-010	Fountain
Z2DB/465993-011	Cobalt
Z2DC/465993-012	Iron

Divina MD - Maharam

59" wide	
100% wool	
Z2301/466150-193	193
Z2302/466150-203	203
Z2303/466150-213	213
Z2304/466150-293	293
Z2305/466150-343	343
Z2306/466150-353	353
Z2307/466150-363	363
Z2308/466150-413	413
Z2309/466150-433	433
Z2310/466150-453	453
Z2311/466150-613	613

Divina MD continued

Z2312/466150-633	633
Z2313/466150-653	653
Z2314/466150-673	673
Z2315/466150-683	683
Z2316/466150-713	713
Z2317/466150-733	733
Z2318/466150-743	743
Z2319/466150-753	753
Z2320/466150-773	773
Z2321/466150-783	783
Z2322/466150-813	813
Z2323/466150-843	843
Z2324/466150-873	873
Z2325/466150-913	913
Z2326/466150-943	943
Z2327/466150-973	973

Divina - Maharam

59" wide	
100% wool	
TF01/460730-154	154
TF03/460730-171	171
TF04/460730-173	173
TF05/460730-181	181
TF06/460730-191	191
TF08/460730-224	224
TF10/460730-334	334
TF13/460730-384	384
TF14/460730-393	393
TF16/460730-444	444
TF17/460730-462	462
TF18/460730-542	542
TF19/460730-552	552
TF20/460730-562	562
TF22/460730-584	584
TF23/460730-623	623
TF25/460730-652	652
TF26/460730-662	662
TF27/460730-671	671
TF29/460730-684	684
TF30/460730-691	691
TF31/460730-692	692

Divina continued

TF33/460730-712	712
TF37/460730-742	742
TF41/460730-782	782
TF42/460730-791	791
TF43/460730-793	793
TF47/460730-893	893
TF49/460730-922	922
TF51/460730-944	944
TF53/460730-984	984
TF55/460730-106	106
TF56/460730-236	236
TF57/460730-246	246
TF58/460730-346	346
TF59/460730-356	356
TF60/460730-376	376
TF61/460730-426	426
TF62/460730-526	526
TF63/460730-536	536
TF64/460730-626	626
TF65/460730-636	636
TF66/460730-666	666
TF67/460730-676	676
TF68/460730-686	686
TF69/460730-696	696
TF70/460730-756	756
TF71/460730-826	826
TF72/460730-836	836
TF73/460730-846	846
TF74/460730-856	856
TF75/460730-876	876
TF76/460730-886	886
TF77/460730-936	936
TF78/460730-956	956
TF79/460730-966	966

Divina Melange — Maharam

59" wide	
100% wool	
TG01/460830-120	120
TG02/460830-170	170
TG03/460830-180	180
TG05/460830-260	260

Divina Melange continued

TG06/460830-280	280
TG07/460830-871	871
TG08/460830-821	821
TG11/460830-731	731
TG12/460830-681	681
TG13/460830-631	631
TG16/460830-581	581
TG17/460830-531	531
TG18/460830-521	521
TG19/460830-571	571
TG21/460830-471	471
TG24/460830-971	971
TG25/460830-920	920
TG26/460830-620	620
TG27/460830-147	147
TG28/460830-227	227
TG29/460830-237	237
TG30/460830-277	277
TG31/460830-367	367
TG32/460830-427	427
TG33/460830-457	457
TG34/460830-467	467
TG35/460830-517	517
TG36/460830-527	527
TG37/460830-547	547
TG38/460830-557	557
TG39/460830-567	567
TG40/460830-597	597
TG41/460830-617	617
TG42/460830-647	647
TG43/460830-677	677
TG44/460830-687	687
TG45/460830-747	747
TG46/460830-757	757
TG47/460830-777	777
TG48/460830-787	787
TG49/460830-917	917
TG50/460830-937	937
TG51/460830-967	967
TG52/460830-977	977

Price category H continued on next page

- Maharam textiles are on assigned lead times **A** unless otherwise noted.
- Fabric numbers are listed as Herman Miller fabric number/Maharam fabric number.

Maharam® Colors — Seating

continued

Price Category H

continued

Dot Pattern — Maharam	
55" wide	
71% cotton	
29% polyester	
ZK01/458300-001	Document
ZK02/458300-002	Taupe
ZK04/458300-004	Red
ZK05/458300-005	Navy

Offset — Maharam	
54" wide	
40% cotton	
36% nylon	
24% wool	
ZQF01/465951-001	Passage
ZQF02/465951-002	Fieldstone
ZQF03/465951-003	Coast
ZQF04/465951-004	Esplanade
ZQF05/465951-005	Oasis
ZQF06/465951-006	Spice
ZQF07/465951-007	Bloom

Pocket - Maharam	
54" wide	
76% recycled polyester	
24% nylon	
ZP301/466243-001	001
ZP302/466243-002	002
ZP303/466243-003	003
ZP304/466243-004	004
ZP305/466243-005	005
ZP306/466243-006	006
ZP307/466243-007	007

Small Dot Pattern — Maharam	
55" wide	
71% cotton	
29% polyester	
ZL01/458320-001	Document
ZL02/458320-002	Sand
ZL03/458320-003	Khaki
ZL04/458320-004	Taupe
ZL05/458320-005	Charcoal
ZL06/458320-006	Document Reverse
ZL07/458320-007	Red
ZL08/458320-008	Yellow
ZL09/458320-009	Green

Steelcut Trio - Maharam	
55" wide	
90% wool	
10% nylon	
V2501/465906-105	105
V2502/465906-113	113
V2503/465906-124	124
V2504/465906-133	133
V2506/465906-153	153
V2507/465906-195	195
V2508/465906-205	205
V2509/465906-213	213
V2513/465906-253	253
V2514/465906-283	283
V2518/465906-383	383
V2523/465906-453	453
V2525/465906-515	515
V2526/465906-533	533
V2527/465906-553	553
V2529/465906-645	645
V2534/465906-713	713
V2542/465906-865	865
V2543/465906-883	883
V2544/465906-915	915
V2545/465906-933	933
V2546/465906-945	945
V2547/465906-953	953
V2548/465906-965	965
V2549/465906-983	983
V2550/465906-176	176

Steelcut Trio continued	
V2551/465906-226	226
V2552/465906-236	236
V2553/465906-246	246
V2554/465906-266	266
V2555/465906-276	276
V2556/465906-336	336
V2557/465906-376	376
V2558/465906-416	416
V2559/465906-426	426
V2560/465906-436	436
V2561/465906-446	446
V2562/465906-466	466
V2563/465906-476	476
V2564/465906-506	506
V2565/465906-526	526
V2566/465906-576	576
V2567/465906-616	616
V2568/465906-636	636
V2569/465906-666	666
V2570/465906-686	686
V2571/465906-716	716
V2572/465906-746	746
V2573/465906-756	756
V2574/465906-776	776
V2575/465906-796	796
V2576/465906-806	806
V2577/465906-906	906
V2578/465906-916	916
V2579/465906-946	946
V2580/465906-966	966
V2581/465906-976	976
V2582/465906-996	996

Tonus - Maharam	
51" wide	
90% wool	
10% helanka	
ZTN01/460800-100	100
ZTN03/460800-109	109
ZTN05/460800-118	118
ZTN10/460800-125	125
ZTN13/460800-128	128
ZTN14/460800-129	129
ZTN15/460800-130	130

Tonus continued	
ZTN16/460800-131	131
ZTN17/460800-132	132
ZTN19/460800-135	135
ZTN21/460800-207	207
ZTN23/460800-210	210
ZTN26/460800-216	216
ZTN27/460800-240	240
ZTN29/460800-440	440
ZTN32/460800-508	508
ZTN34/460800-605	605
ZTN35/460800-608	608
ZTN36/460800-609	609
ZTN37/460800-610	610
ZTN38/460800-613	613
ZTN40/460800-615	615
ZTN41/460800-619	619
ZTN51/460800-631	631
ZTN54/460800-634	634
ZTN56/460800-636	636
ZTN59/460800-690	690
ZTN62/460800-840	840
ZTN63/460800-940	940
ZTN65/460800-224	224
ZTN66/460800-244	244
ZTN67/460800-364	364
ZTN68/460800-374	374
ZTN69/460800-394	394
ZTN70/460800-424	424
ZTN71/460800-454	454
ZTN72/460800-464	464
ZTN73/460800-474	474
ZTN74/460800-554	554
ZTN75/460800-654	654
ZTN76/460800-664	664
ZTN77/460800-684	684
ZTN78/460800-754	754
ZTN79/460800-764	764
ZTN80/460800-854	854
ZTN81/460800-914	914
ZTN82/460800-934	934
ZTN83/460800-954	954
ZTN84/460800-964	964
ZTN85/460800-974	974

- Maharam textiles are on assigned lead times ^A unless otherwise noted.
- Fabric numbers are listed as Herman Miller fabric number/Maharam fabric number.

Maharam® Colors — Seating

continued

Appendix: Maharam Colors — Seating

Price Category I

Cursive – Maharam	
54" wide	
67% solution-dyed acrylic	
33% solution-dyed polyester	
PFOA-Free stain resistant	
7CW01/466335-001	Fast
7CW02/466335-002	Hunt
7CW03/466335-003	Beachcomb
7CW04/466335-004	Twist
7CW05/466335-005	Swift
7CW06/466335-006	Jetstream
7CW07/466335-007	Inkwell
7CW08/466335-008	Rubber

Study - Maharam	
54" wide	
73% solution-dyed acrylic	
27% solution-dyed polyester	
ZSY01/466269-001	001
ZSY02/466269-002	002
ZSY03/466269-003	003
ZSY04/466269-004	004
ZSY05/466269-005	005

Teatro - Maharam	
55" wide	
100% polyester	
Polyester/Cotton backing	
ZT201/466309-001	Crumb
ZT203/466309-003	Herd
ZT206/466309-006	Heat
ZT207/466309-007	Caspian
ZT209/466309-009	Boulder
ZT210/466309-010	Elixir
ZT211/466309-011	Guard
ZT212/466309-012	Throne

Price Category J

Hallingdal - Maharam	
51" wide	
70% wool	
30% rayon	
Z2401/460760-100	100
Z2402/460760-103	103
Z2403/460760-110	110
Z2404/460760-113	113
Z2405/460760-116	116
Z2406/460760-123	123
Z2407/460760-126	126
Z2408/460760-130	130
Z2409/460760-143	143
Z2410/460760-153	153
Z2411/460760-166	166
Z2412/460760-173	173
Z2413/460760-180	180
Z2414/460760-190	190
Z2415/460760-200	200
Z2416/460760-220	220
Z2417/460760-224	224
Z2418/460760-227	227
Z2419/460760-270	270
Z2420/460760-350	350
Z2421/460760-368	368
Z2422/460760-370	370
Z2423/460760-376	376
Z2424/460760-390	390
Z2425/460760-407	407
Z2426/460760-420	420
Z2427/460760-457	457
Z2428/460760-526	526

Hallingdal continued	
Z2429/460760-547	547
Z2430/460760-563	563
Z2431/460760-573	573
Z2432/460760-590	590
Z2433/460760-596	596
Z2434/460760-600	600
Z2435/460760-657	657
Z2436/460760-660	660
Z2437/460760-674	674
Z2438/460760-680	680
Z2439/460760-687	687
Z2440/460760-694	694
Z2441/460760-702	702
Z2442/460760-723	723
Z2443/460760-733	733
Z2444/460760-750	750
Z2445/460760-753	753
Z2446/460760-754	754
Z2447/460760-763	763
Z2448/460760-764	764
Z2449/460760-773	773
Z2450/460760-810	810
Z2451/460760-840	840
Z2452/460760-850	850
Z2453/460760-890	890
Z2454/460760-907	907
Z2455/460760-944	944
Z2456/460760-960	960
Z2457/460760-968	968
Z2458/460760-980	980

Price Category K

Coda by Kvadrat - Maharam	
55" wide	
90% wool	
10% nylon	
ZC701/464480-100	100
ZC702/464480-103	103
ZC703/464480-116	116
ZC704/464480-182	182
ZC705/464480-222	222
ZC706/464480-232	232
ZC707/464480-242	242
ZC708/464480-362	362
ZC709/464480-382	382
ZC710/464480-410	410
ZC711/464480-422	422
ZC712/464480-442	442
ZC713/464480-610	610
ZC714/464480-632	632
ZC715/464480-642	642
ZC716/464480-722	722
ZC717/464480-762	762
ZC718/464480-962	962

- Maharam textiles are on assigned lead times A unless otherwise noted.
- Fabric numbers are listed as Herman Miller fabric number/Maharam fabric number.

Maharam® Colors — Seating

continued

Price Category L

Minicheck - Maharam

55" wide
 78% cotton
 22% polyester
 PFOA-Free stain resistant finish
 ZMK01/466268-001 Black/White

Price Category M

Fruit - Maharam

54" wide
 55% cotton
 32% nylon
 13% post-consumer recycled polyester
 PFOA-Free stain resistant finish
 Acrylic backing
 ZF201/466262-001 Opal
 ZF202/466262-002 Lime
 ZF203/466262-003 Olive
 ZF204/466262-004 Sky
 ZF205/466262-005 Kernal
 ZF206/466262-006 Droplet
 ZF207/466262-007 Russet

Price Category N-Z

No fabrics available at this time.

- Maharam textiles are on assigned lead times A unless otherwise noted.
- Fabric numbers are listed as Herman Miller fabric number/Maharam fabric number.

For more information about our products and services or to see a list of dealers, please visit us at HermanMiller.com or call (800) 851 1196.

© 2020 Herman Miller, Inc., Zeeland, Michigan

Distribution Rights

Working together since 1956, Herman Miller and Vitra are the authentic sources of designs by Charles and Ray Eames, Alexander Girard, and George Nelson. All the designs shown in this book are protected by law. Herman Miller has obtained all rights to make and sell these designs. Also, Herman Miller holds exclusive worldwide manufacturing and distribution rights for these products with the following exceptions:

Charles and Ray Eames, George Nelson, and Alexander Girard—Worldwide distribution rights for furniture in all areas except Europe and the Middle East. For those areas, please contact Vitra.

Isamu Noguchi—Worldwide distribution rights for the Noguchi Rudder Table. Distribution rights for the Noguchi Table in North America and Central America only. For all other areas, please contact Vitra.

Magis—Exclusive distribution rights in the US and Canada. For all other areas, please contact Magis.

Mattiazzi—Exclusive distribution rights in the US and Canada. For all other areas, please contact Mattiazzi.

® **HermanMiller**, ●, 3D Intelligent, AO, Action Office, Aeron, ArcSpan, Aside, Avall, Bubble Lamps, Canvas Office Landscape, Caper, Celle, Co/Struc, Daisyone, Distil, Eames, Eco-Dematerialized, Embody, Envelop, Ethospace, Exclave, Fine-Tune, FlexFront, Flo, Formcoat, Formwork, Ground Cloth, Herman Miller for the Home, Herman Miller for Healthcare, Intersect, Kinemat, Layout Studio, Lifework, Limerick, Live Unframed, Living Office, Locale, Maharam, Meridian, Mirra, Motia, Pellicle, Perspectives, Plex, PostureFit, Public Office Landscape, Resolve, Rodney, Sayl, Setu, Thrive, Tu, Wishbone, and Y-Tower are among the registered trademarks of Herman Miller, Inc., and its owned subsidiaries.

™ 8Z Pellicle, About Face, AireWeave, Albert, Backfit, Bubbletack, Burdick Group, Butterfly Back, Cellular Suspension, Clam, Commend, Compass, Connect, Cosm, DOT, Duracare, Durawrap, Eames Soft Pad, EnhancedAccess, Everywhere, Flex-Edge, Flute, Harmonic, Headway, Herman Miller Select, Hopsak 2, Intent, Iota, Jaw, Keyless Entry, Keyn Chair Group by Herman Miller, Latitude, Lino, Locale, Logic Mini, Logic Power Access Solutions, Live Platform, Loop, Lyris, Lyris 2, Made-to-Measure Storage, Mora, Multiscrim, Nelson, Nevi, Overlay, Pari, Pixelated Support, PostureFit SL, Prospect, Renew, Sense, Soft Pad, Stackable, Stackable Storage, Striad, Swoop, Tone, TriFlex, Twist, Ubi, Valor, Verus, Vista and Wireframe are among the trademarks of Herman Miller, Inc., and its owned subsidiaries.

SM Herman Miller Options is among the service marks of Herman Miller, Inc.

AAP™ is a trademark of Extron Electronics.

Alexander Girard® is a registered trademark of The Alexander Girard Estate.

Chemsur® is a registered trademark of Wilsonart International.

Corian® is a registered trademark of E. I. du Pont de Nemours and Company Corporation.

Crypton® is a registered trademark of Crypton, Inc.

DACRON® is a registered trademark of INVISTA S.a r.l.

Danzer® is a registered trademark of Danzer Holding AG.

Decora® is a registered trademark of Leviton Manufacturing Co., Inc.

Edelman® Leather is a registered trademark of Edelman Leather, Inc.

Extron® is a registered trademark of RGB Systems, Inc.

FENIX NTM® is a registered trademark of Arpa Industriale S.p.A.

FLEXNET™ is a trademark of Milliken & Company.

Floor Saver Glide® is a registered trademark of Carpin Manufacturing, Inc.

Geiger® is a registered trademark, and Bumper™, Saiba™, and Ward Bennett™ are trademarks, of Geiger International.

Goetz™ is a trademark of Mark W. Goetz.

Hang-It-All® is a registered trademark of Lucia Eames Demetrios, d.b.a. Eames Office.

Holophane® is a registered trademark of Holophane.

Ingeo™ is a trademark of Cargill Dow LLC.

iPad® is a registered trademark of Apple, Inc.

Leviton® is a registered trademark of Leviton Manufacturing Co., Inc.

LifeSize® is a registered trademark of LifeSize Communications, Inc.

Magis®, Bombo®, and Me Too® are registered trademarks of Magis S.p.A.

Microsoft® and Natural® Keyboard are registered trademarks of Microsoft Corporation.

Noguchi® and the Noguchi table configuration (trade dress) are registered trademarks, and Rudder Table™ is a trademark, of The Isamu Noguchi Foundation and Garden Museum.

Place Textiles® is a registered trademark of Place Textiles.

SuperSeat™ is a trademark of Dahti Seating, a division of ITW.